

Prosthetic Manual
Crowns and Bridges

PREMIUM KOHNO SHELTA



PREMIUM KOHNO - SHELTA



Guide to the sequence of use of prosthetic components

4



Platform connection

16

Overview of diameters, emergence profiles, implant connections and colour codes Premium Kohno

16

Overview of diameters, emergence profiles, implant connections and colour codes Shelta

18

Collex connection

20

Collex ONE connection

22

Implant Platform Switching

24

Prosthetic Platform Switching

24

Contracone seal

25



Prosthetics instruments

26

Screw Kit

26

Drivers for fixation screws

28

CRI5-KIT torque-control ratchet

32



Protocols for use

34

Techniques for taking impressions and making models

34

Soft tissues conditioning with healing abutments

56

Soft tissues conditioning with temporary rehabilitations using Simple posts

60

Definitive rehabilitation with pre-made posts

72

Definitive rehabilitation with preparable posts

82

Definitive rehabilitation with castable posts with a metal base

94

Temporary and definitive rehabilitation with intermediate abutments

108

Temporary and definitive rehabilitation with PLAIN abutments

116

Temporary and definitive rehabilitation with P.A.D. abutments

126

Temporary and definitive rehabilitation with vertical technique

146

Temporary and definitive rehabilitation with Conoweld conometric technique

163

Definitive rehabilitation with T-Connect

177

Definitive rehabilitation with Dynamic Abutments

185



General indications

193

Composition of materials

193

Advice for overcasting with base alloys

201

General clinical indications

202

Guide to the sequence of use of prosthetic components

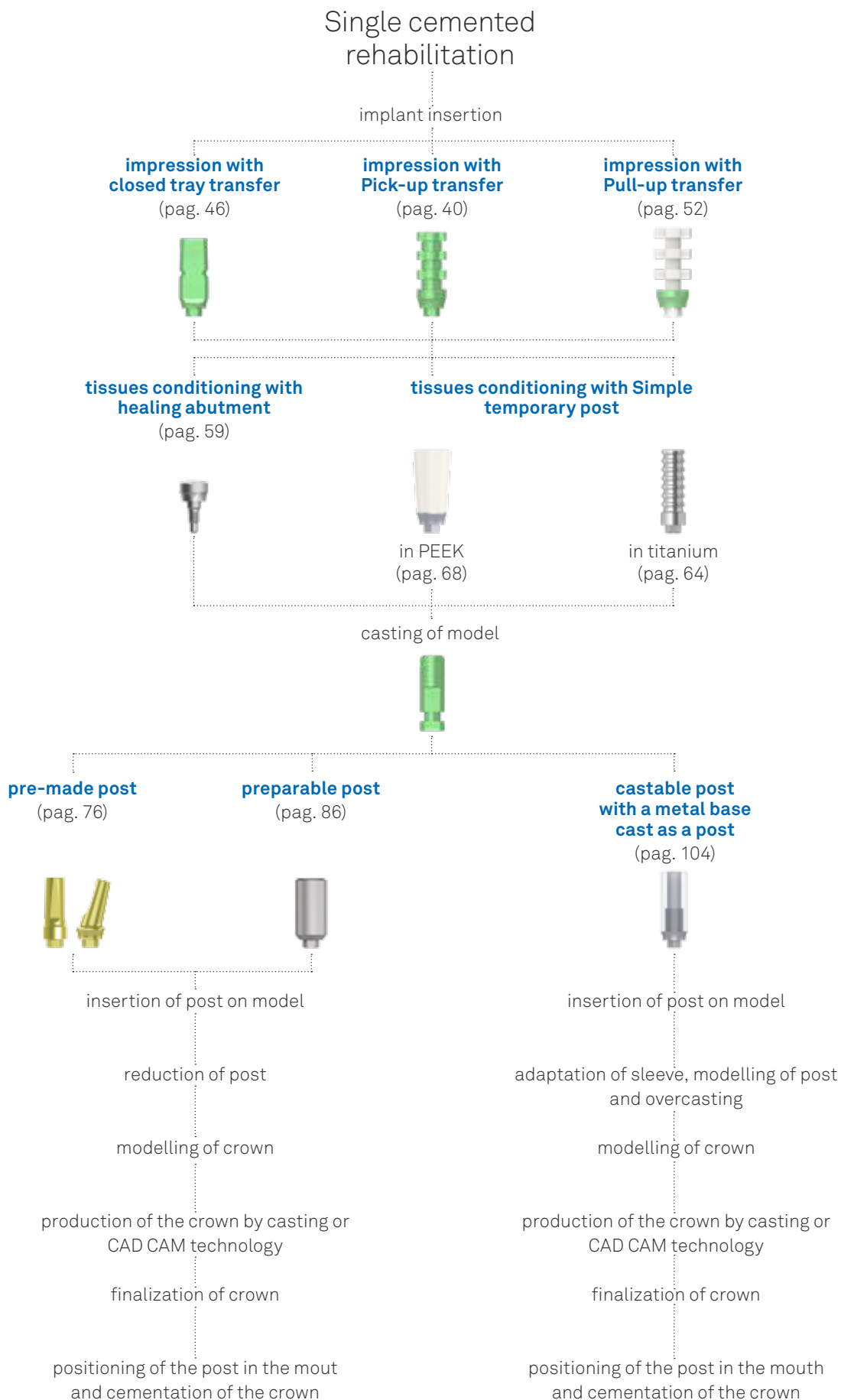

Single screw retained rehabilitation

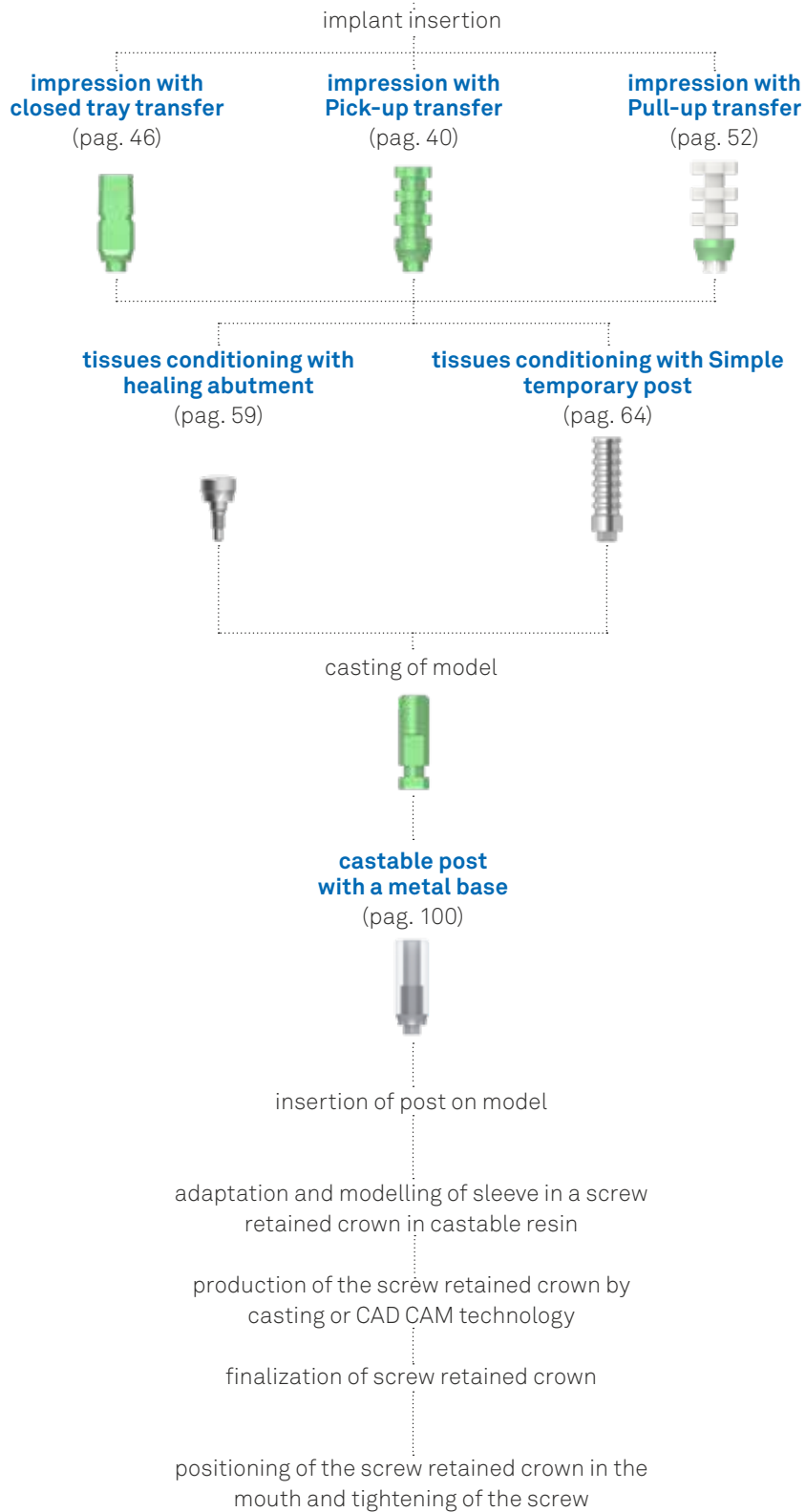

Multiple cemented rehabilitation

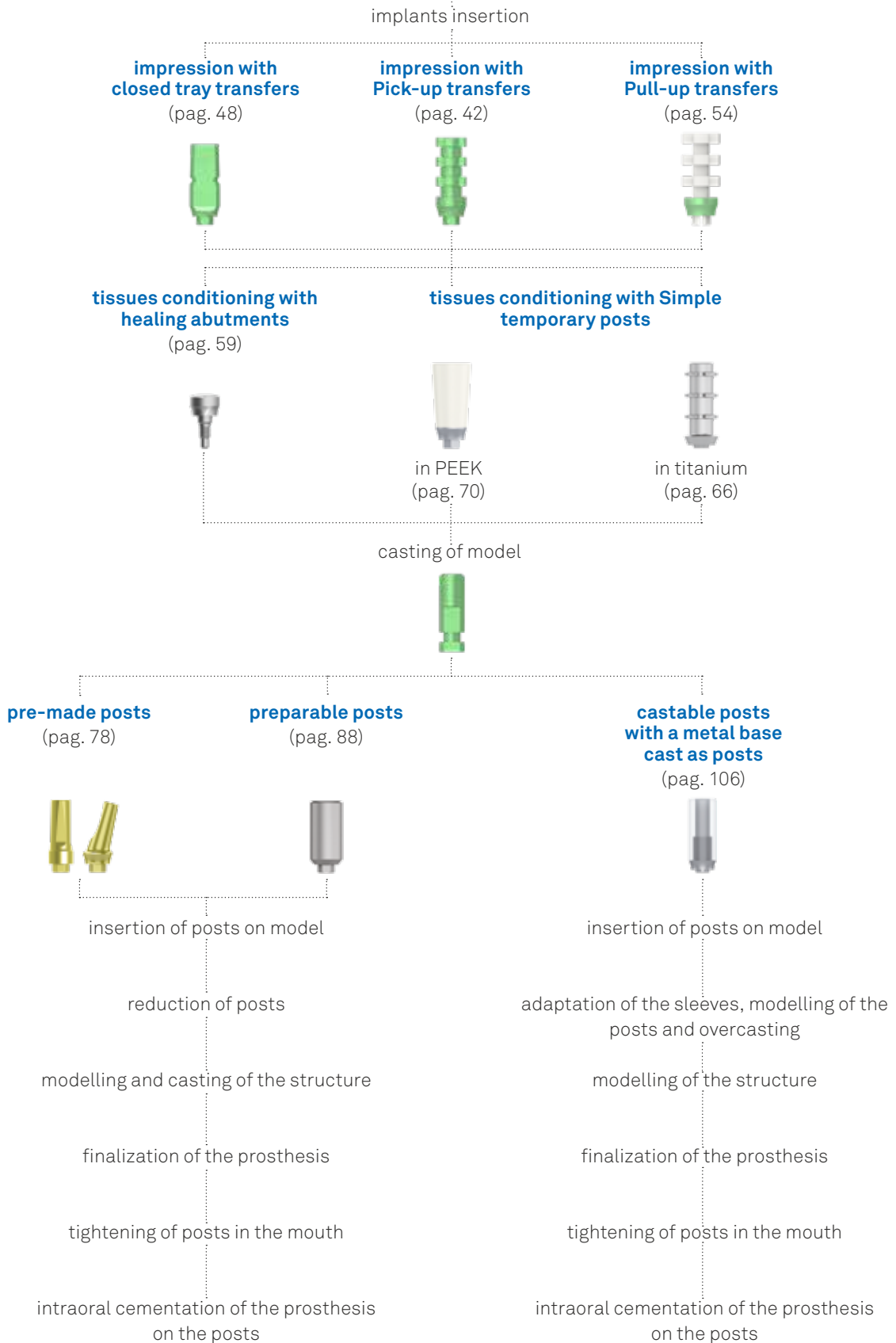

Multiple screw retained rehabilitation

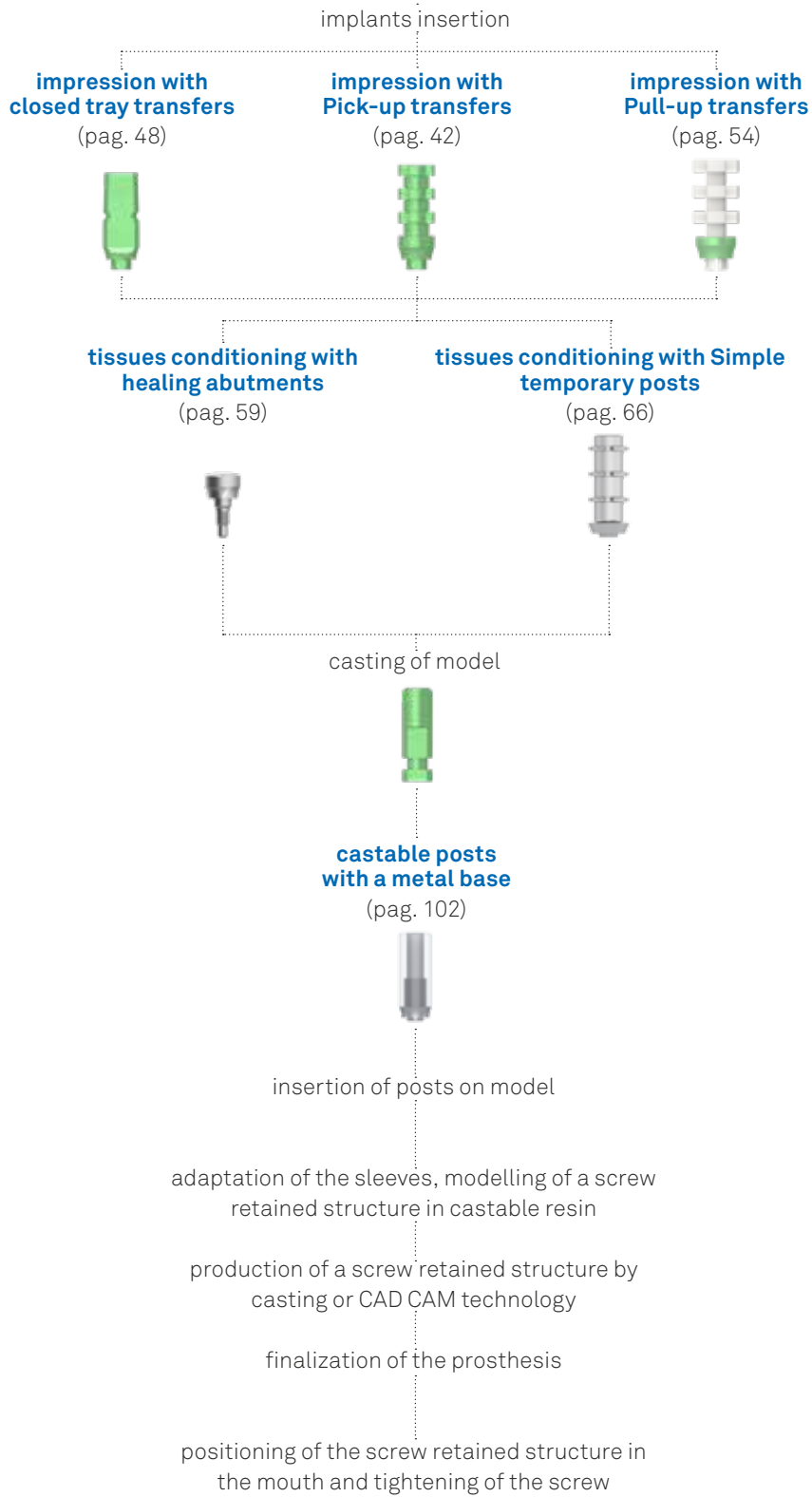

Single and multiple cemented rehabilitation with millable posts for Interceptiv Technique

implants insertion

preparable post for Interceptiv Technique

(pag. 90)



closed tray impression

tissues conditioning with healing abutments

(pag. 59)



casting of model



repositioning of the posts for Interceptiv Technique on the model

reduction of posts

modelling and production of the structure by casting or CAD CAM technology

finalization of the prosthesis

tightening of posts in the mouth

intraoral cementation of the prosthesis on the posts

Multiple screw retained rehabilitation with intermediate abutments

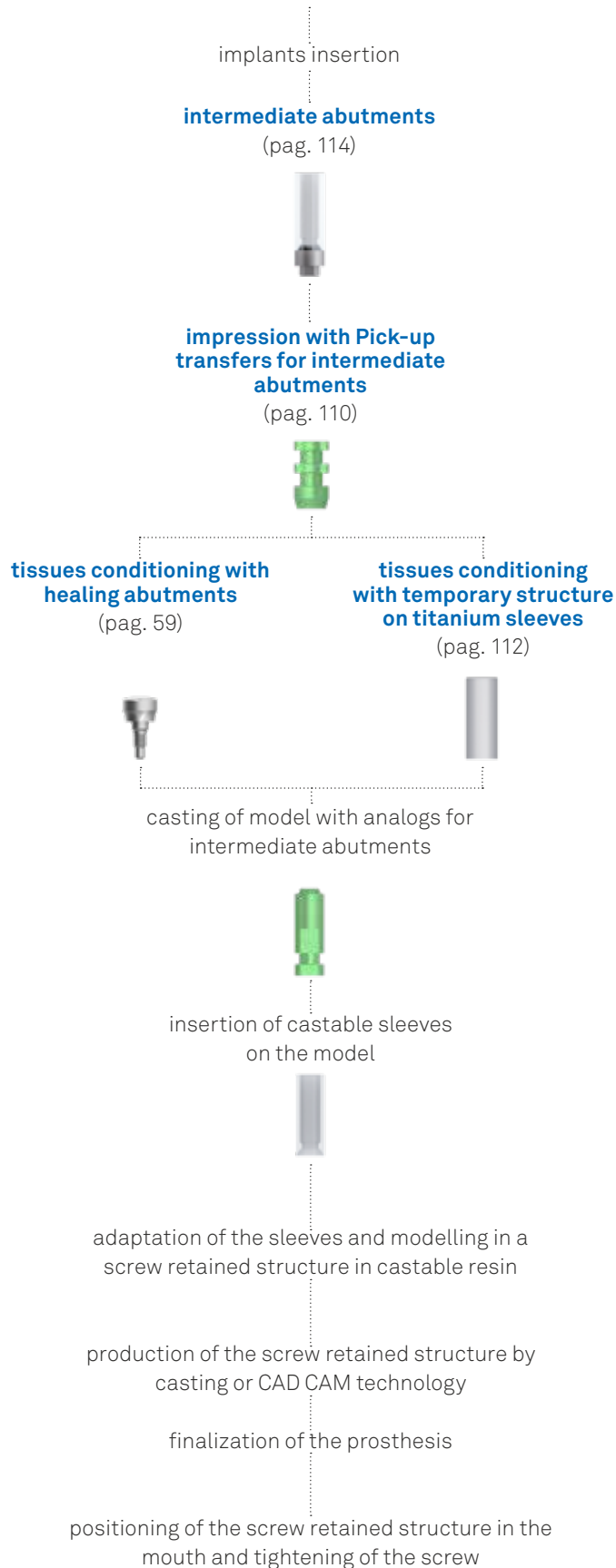

Multiple screw retained rehabilitation with PLAIN abutments

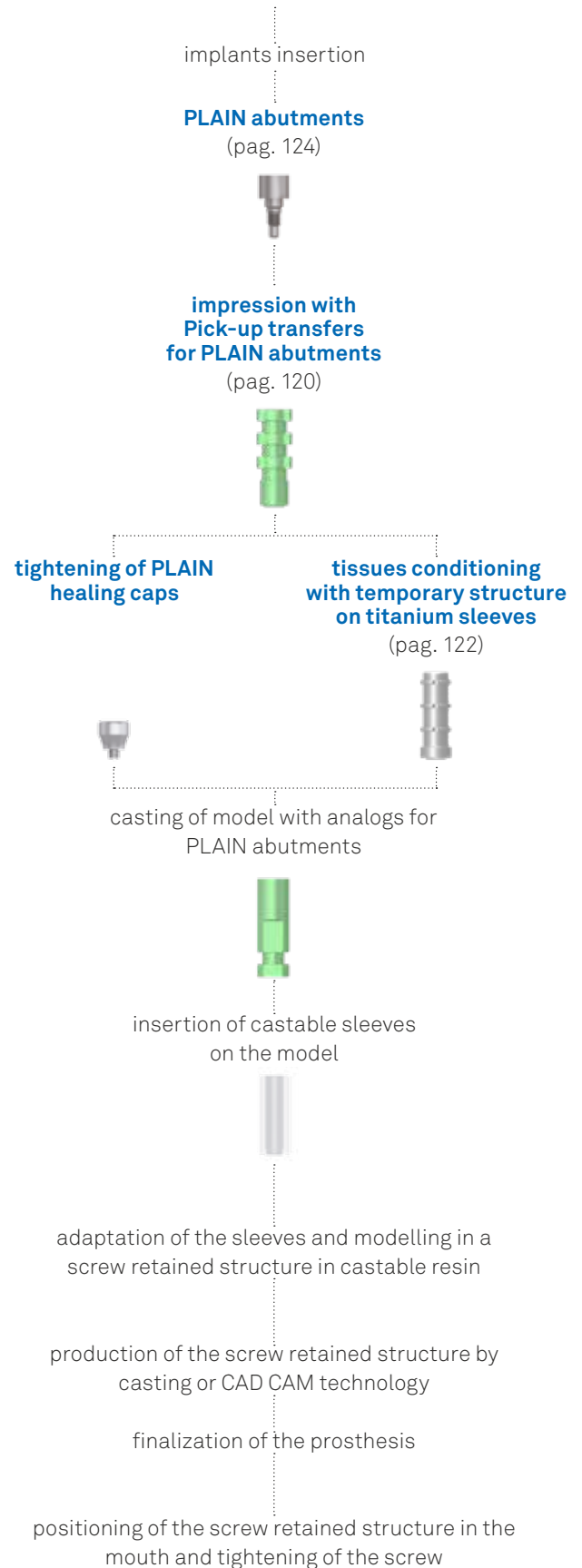

Multiple rehabilitation with P.A.D. abutments (Disparallel Screwed Prosthesis)



Single cemented rehabilitation with vertical technique

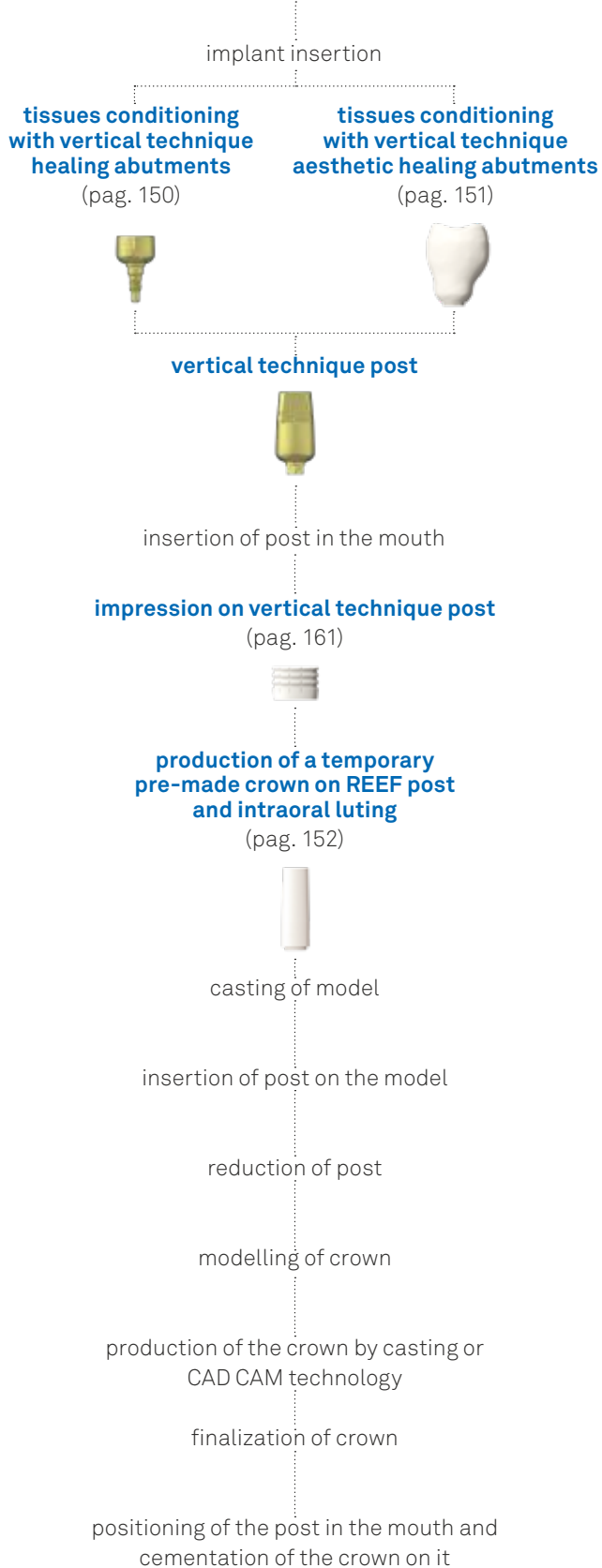

Multiple cemented rehabilitation with vertical technique

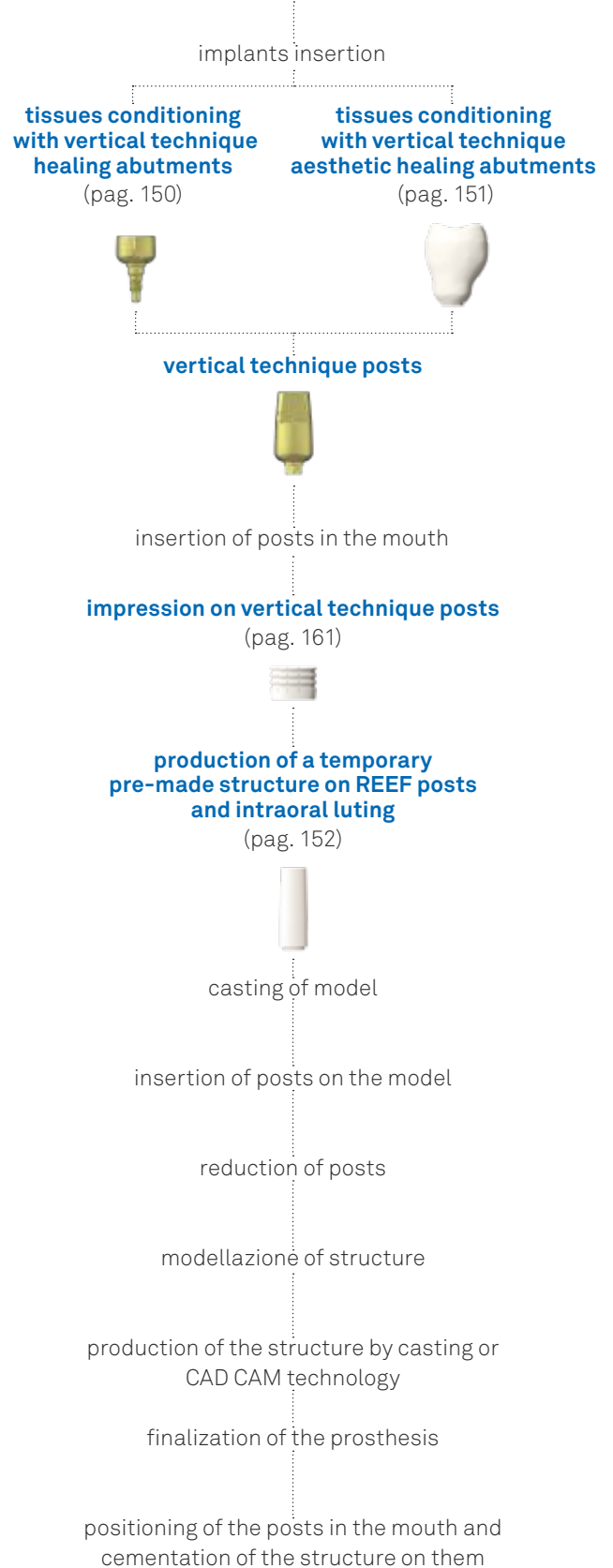

Multiple rehabilitation with Conoweld conometric technique

implants insertion

Conoweld posts



insertion of Conoweld posts in the mouth

production of a temporary structure by intraoral welding

(pag. 168)



impression on the structure

impression with PMMA caps

(pag. 172)



production of a temporary prosthesis

casting of model

insertion of the definitive caps for luting on the posts on the model

(pag. 174)



modelling of the structure

production of the structure by casting or CAD CAM technique

finalization of the prosthesis

luting of the structure on the caps

positioning of the structure in the mouth on Conoweld posts by conometric technique

insertion of the PMMA caps on the analogs on the model

(pag. 176)



reduction of the caps

modelling of the structure

production of the structure by casting or CAD CAM technique

finalization of the prosthesis

check and luting of the prosthesis on Conoweld posts

positioning of the screw retained structure in the mouth and tightening of the screw

Single rehabilitation with T-Connect: luting technique

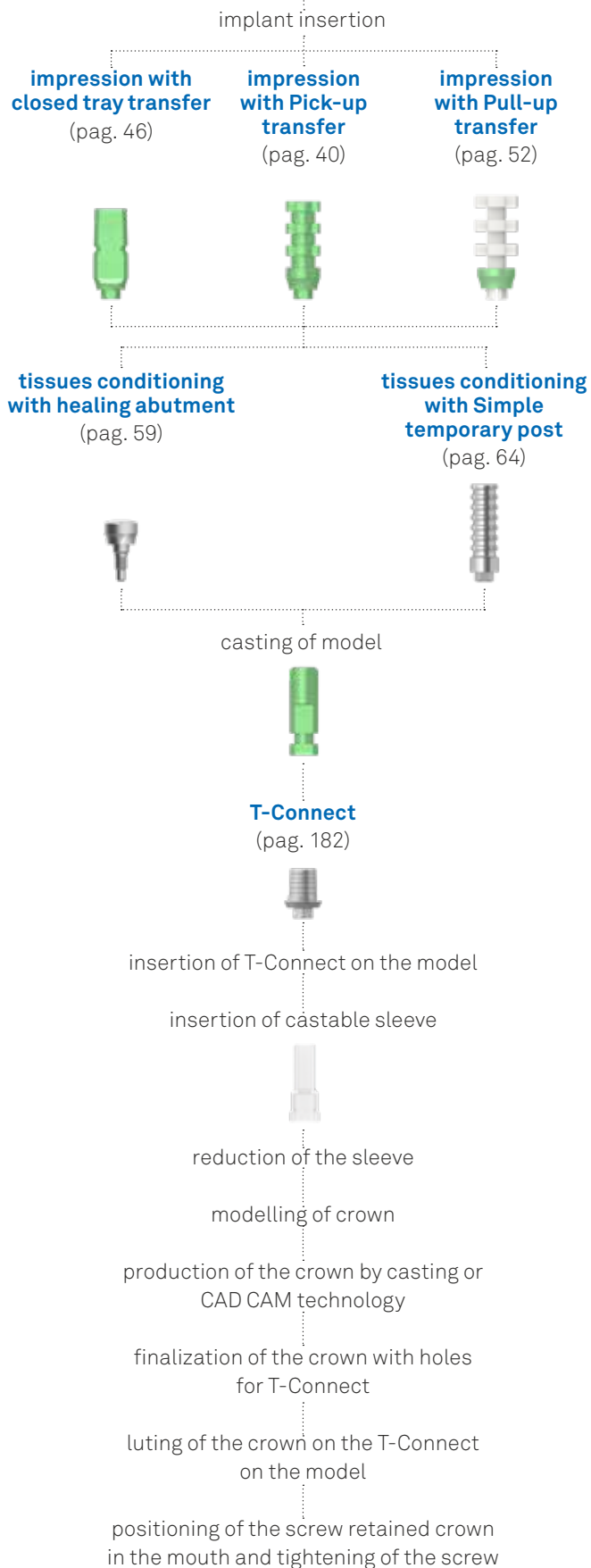

Multiple rehabilitation with T-Connect: luting technique

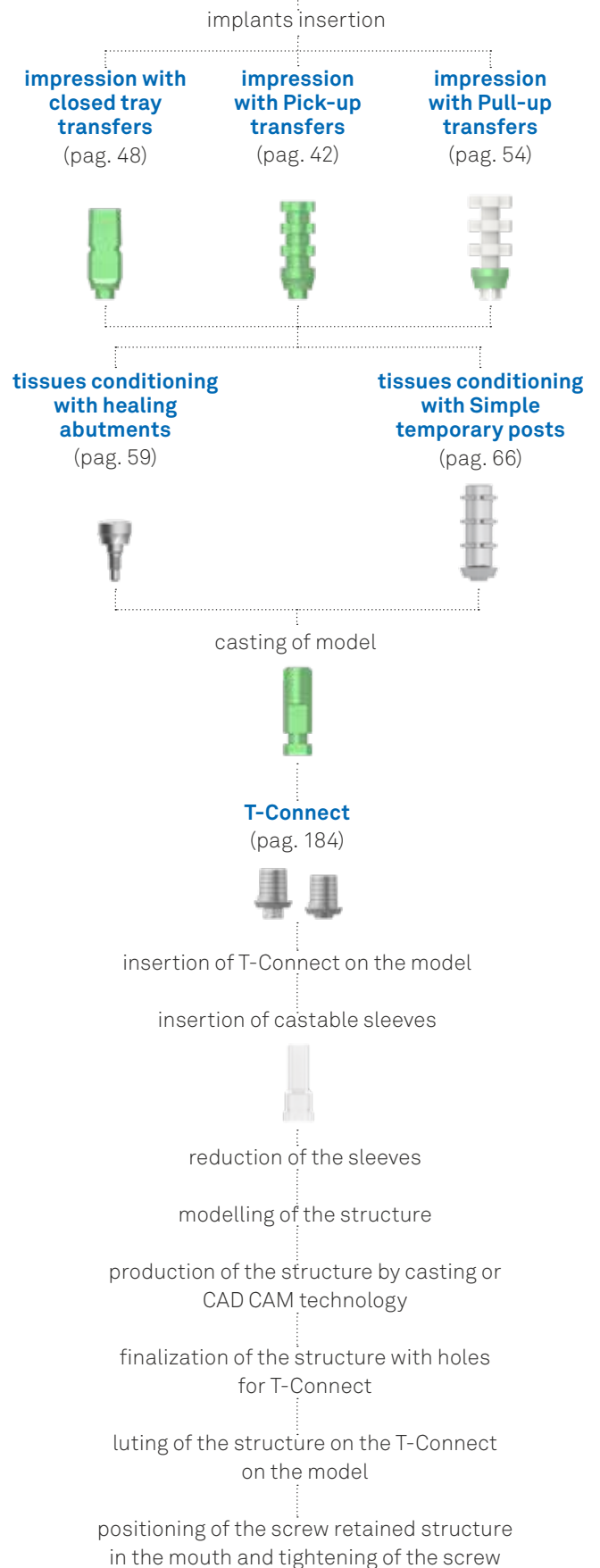

Single screw retained rehabilitation with Dynamic Abutment

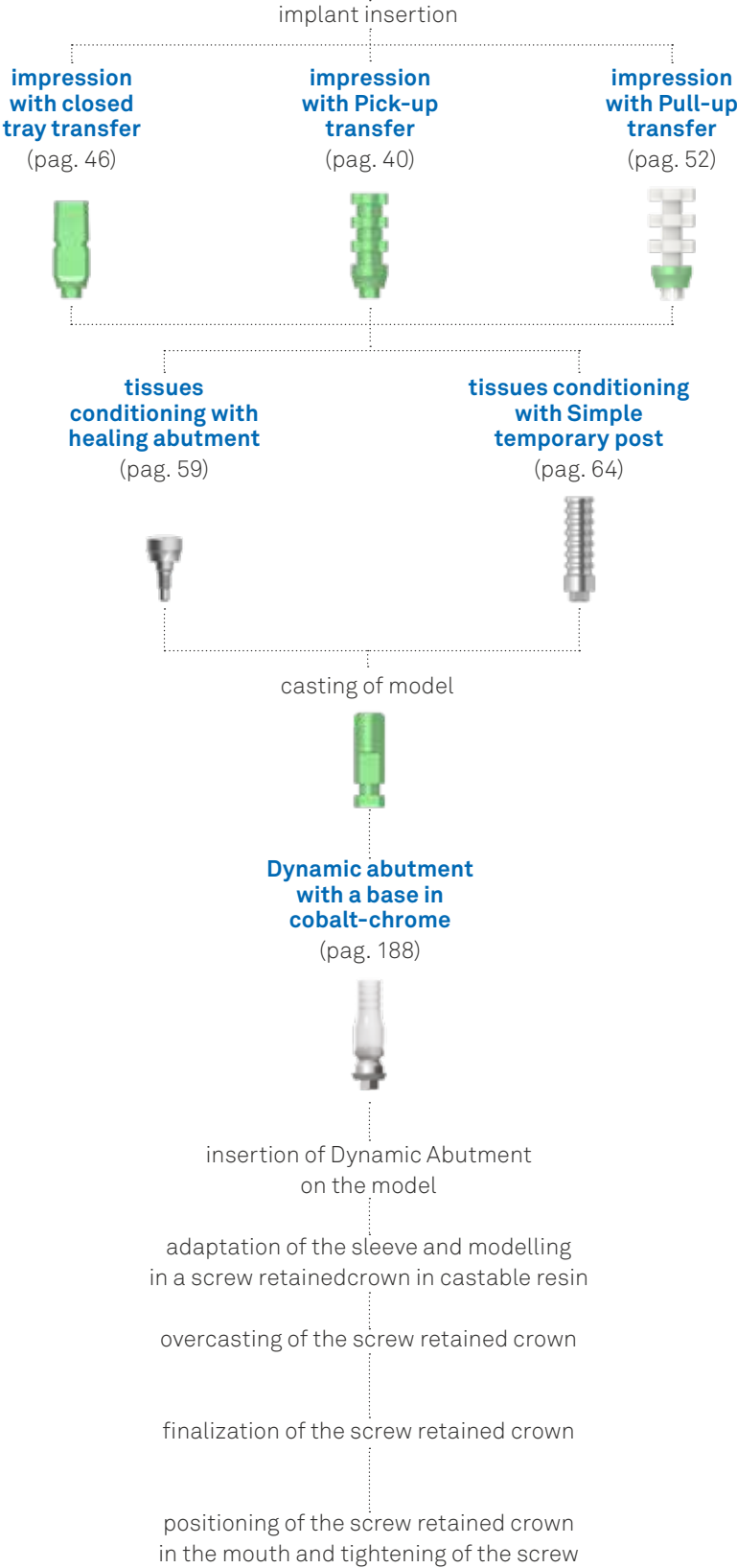



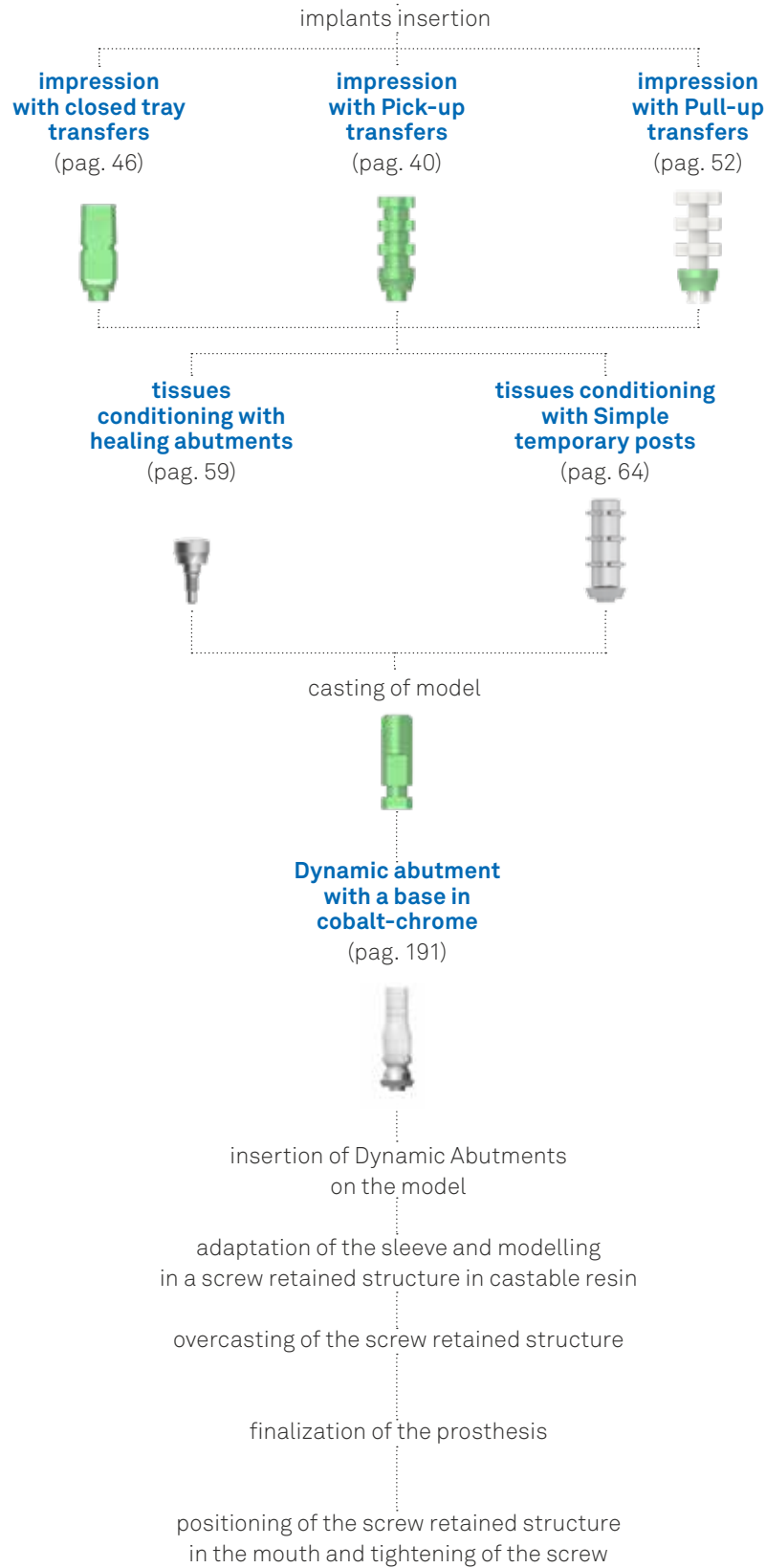













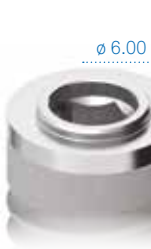



















Multiple screw retained rehabilitation with Dynamic Abutment



Overview of diameters, emergence profiles, implant connections and colour codes Premium Kohno*

	Premium	Premium Kohno		
ø implant	3.30 Straight	3.80 Straight	3.80 SP	4.25 Straight
colour code (on pack)				
maximum emergence ø connection platform ø				
main dimensions				
external collar ø internal collar ø				
width across flats				
with post of smaller ø				
prosthetic compatibility				
with post of compatible ø				
implant analogs				
Pull-up transfer				
closed tray transfer				
Pick-up transfer				
fixation screw (thread and colour)				

All measurements are in mm, unless otherwise indicated.
 *Some products may not be released for sale in all markets

Premium Kohno			Kohno
4.25 SP	5.00 Straight	5.00 SP	6.00 Straight
			
			
			
			
			
			
			
			
			
			
M 2.0	M 2.0	M 2.0	M 2.0

Overview of diameters, emergence profiles, implant connections and colour codes Shelta*

	Shelta, Shelta SL	
ø implant	3.80	4.25
colour code (on pack)		
connection platform ø		
main dimensions		
external collar ø		
internal collar ø		
with post of smaller ø		
prosthetic compatibility		
with post of compatible ø		
implant analogs		
Pull-up transfer		
closed tray transfer		
Pick-up transfer		
fixation screw (thread and colour)		
	M 1.8	M 1.8

Shelta, Shelta SL	Shelta
5.00	6.00
	
	
	
 	
	
	
	
	
 <p>M 1.8</p>	 <p>M 1.8</p>

Collex connection

The COLLEX connection, documented since 1996, has a large internal hexagon and a collar that guides the prosthetic manoeuvres.

This interlocking solution gives the implant-prosthetic complex great stability and solidity, also helping to correctly distribute masticatory loads.

The limitation of micromovement, ensured by the presence of the collar, increases the duration over time of prosthetic rehabilitations and protects implants against potentially harmful stresses.

The COLLEX connection exercises the same function of stability regardless of the implant emergence profile, which can be straight in the case of Straight implants or bevelled in the case of SP implants for the Platform Switching technique.

The collar on the COLLEX connection also acts as a guide to facilitate the engagement of the Easy Insert driver, the patented Sweden & Martina system for the mountless insertion of Premium, Kohno and Shelta implants that conserves the precision of the internal hexagon of the connection during implant insertion, an extremely important factor for the subsequent phase of prosthetic rehabilitation.



COLLEX connection
Premium implants
ø 3.30 mm



COLLEX connection
Premium Straight implants
ø 3.80, 4.25, 5.00 mm
Kohno Straight implants
ø 3.80, 4.25, 5.00, 6.00 mm



COLLEX connection
Premium Kohno SP implants
ø 3.80, 4.25, 5.00 mm



ø 3.30 mm

ø 3.80 mm

ø 4.25 mm

ø 5.00 mm

ø 6.00 mm

Important warning

For the same implant diameters, implants with a Straight emergence profile and with a Platform Switching emergence profile use the same prosthetic components, and no distinctions will therefore be made between them in this manual.

Possible combinations of Premium Kohno implant-prosthetic diameters

As following, Premium and Kohno implants are shown coupled with standard pre-made posts to make it easier to see all the possible combinations of fixture diameters and the diameters of prosthetic components.

Premium Straight and Kohno Straight: standard protocols (without Platform Switching technique)



Premium
Straight \varnothing 3.30 mm
post \varnothing 3.30 mm



Premium and Kohno
Straight \varnothing 3.80 mm
post \varnothing 3.80 mm



Premium and Kohno
Straight \varnothing 4.25 mm
post \varnothing 4.25 mm



Premium and Kohno
Straight \varnothing 5.00 mm
post \varnothing 5.00 mm



Kohno
Straight \varnothing 6.00 mm
post \varnothing 6.00 mm

Premium SP and Kohno SP: protocols with implant Platform Switching technique



Premium and Kohno
SP \varnothing 3.80 mm
post \varnothing 3.80 mm



Premium and Kohno
SP \varnothing 4.25 mm
post \varnothing 4.25 mm



Premium and Kohno
SP \varnothing 5.00 mm
post \varnothing 5.00 mm

Premium SP and Kohno SP: protocols with prosthetic Platform Switching technique



Premium and Kohno
SP \varnothing 3.80 mm
post \varnothing 3.30 mm



Premium and Kohno
Straight \varnothing 3.80 mm
post \varnothing 3.30 mm



Kohno
Straight \varnothing 6.00 mm
post \varnothing 5.00 mm

Collex ONE connection

Shelta and Shelta SL implants present the same COLLEX connection in all the diameters of the implant system. The COLLEX ONE connection allows an optimization of the prosthetic and surgical phases, given that the same prosthetic components can be used with all the implants of the system.



The strength properties of the COLLEX connection are also documented by a study carried out by the group of Prof. Covani, in which, comparing this connection with another internal hexagon connection but without the external prosthetic collar, the results highlighted values 25% higher in terms of robustness and prosthetic stability of the COLLEX compared to the connection without collar.

Collex ONE connection
Shelta implants
ø 3.80, 4.25, 5.00, 6.00 mm

FEM analysis of a ø 3.80 mm Shelta implant in connection with a ø 3.80 mm post: the results show how the collar of the COLLEX works correctly and is therefore extremely important for a correct distribution of the prosthetic load.

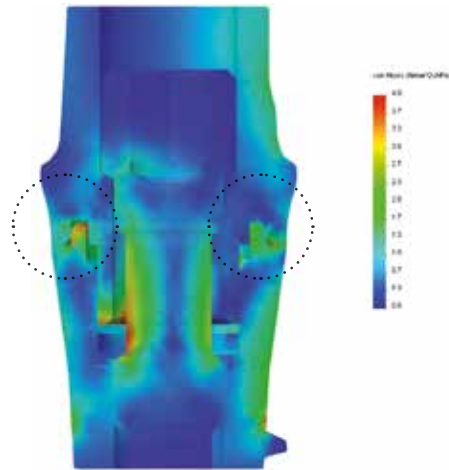

Covani U., Ricci M., Tonelli P., Barone A.
An evaluation of new designs in implant-abutment connections: a finite element method assessment
Implant Dentistry Volume 22, Number 3 3013

2.30



Possible combinations of Shelta implant-prosthetic diameters

As following, Shelta implants are shown coupled with standard pre-made posts to make it easier to see all the possible combinations of fixture diameters and the diameters of prosthetic components.

Shelta: standard protocols (without Platform Switching technique)



Shelta
 \varnothing 3.80 mm
 post \varnothing 3.80 mm



Shelta
 \varnothing 4.25 mm
 post \varnothing 4.25 mm



Shelta
 \varnothing 5.00 mm
 post \varnothing 5.00 mm

Shelta: protocols with prosthetic Platform Switching technique



Shelta
 \varnothing 3.80 mm
 post \varnothing 3.30 mm*



Shelta
 \varnothing 4.25 mm
 post \varnothing 3.80 mm



Shelta
 \varnothing 5.00 mm
 post \varnothing 3.80 mm



Shelta
 \varnothing 5.00 mm
 post \varnothing 4.25 mm



Shelta
 \varnothing 6.00 mm
 post \varnothing 3.80 mm



Shelta
 \varnothing 6.00 mm
 post \varnothing 4.25 mm



Shelta
 \varnothing 6.00 mm
 post \varnothing 5.00 mm

*Prosthetic components with \varnothing 3.30 mm are used to create prosthetic Platform Switching with \varnothing 3.80 implants. It is advisable to use them for single crowns in frontal sectors (excluding premolars) and to support multiple prostheses in distal sector, and are not to be used with implants with \varnothing 4.25, 5.00 and 6.00 mm.

Implant Platform Switching

The Platform Switching protocol, a prosthetic method amply validated by scientific literature, moves the junction between the implant and the post away from the crestal bone. This result can be achieved either by improvising a broadened emergence at the level of the implant neck, or by using posts of a smaller diameter than the implant platform, where the geometry of the connection is the same for all sizes of the range. Premium Kohno SP implants were specifically developed to permit prosthetic rehabilitations using the Platform Switching protocol, with the bevel around the connection platform effectively moving the prosthetic junction further away both vertically and horizontally. The morphology of the implant neck also gives excellent primary stability. The Platform Switching technique used in these implants is called “Implant Platform Switching”, as it is inherent in the morphology of the fixture.

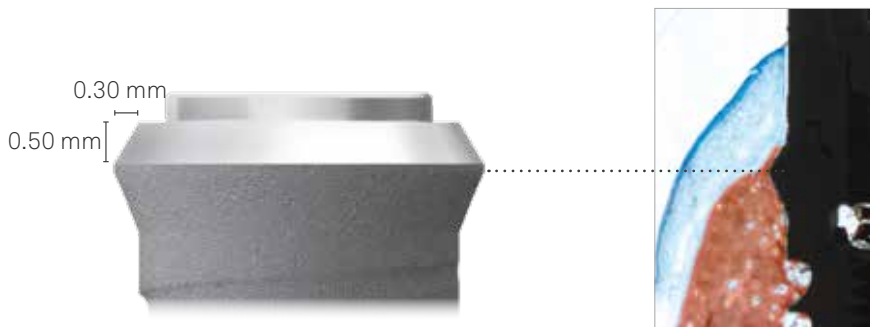

Ground section of a Premium Platform Switching implant at 4 months after insertion. (Image by kind permission of Dr D. Botticelli)

Prosthetic Platform Switching

As demonstrated by literature, there is a relationship between the extension of Platform Switching (mismatching) and preservation of the marginal bone dimensions. In fact, the greater the mismatch, the greater the volumes of hard and soft tissues around the dental implant. The undeniable advantage of one single connection, which is characterized in Shelta implants, is that it allows choosing the desired level of mismatching based on the aesthetic and functional needs of each individual case.

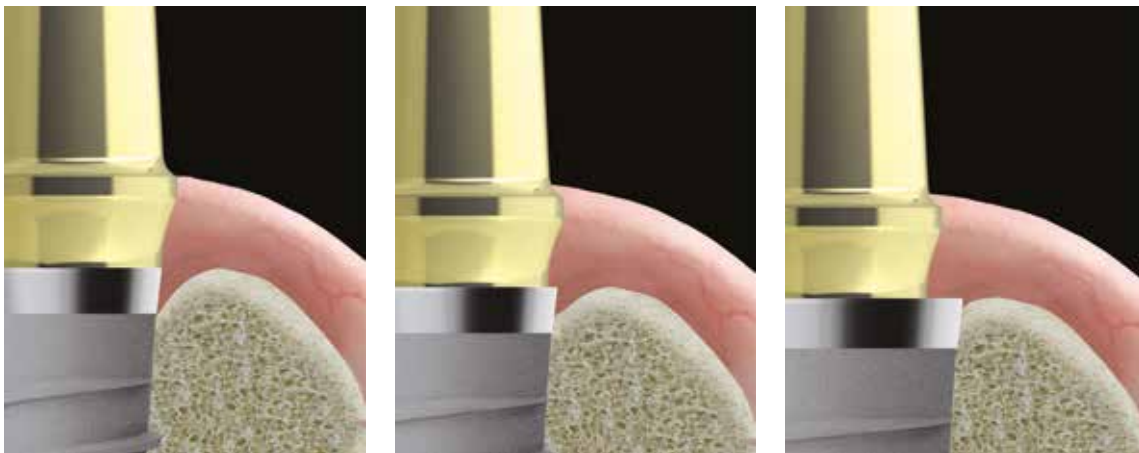

Peri-implant bone reabsorption of implants rehabilitated with the Platform Switching technique is inversely proportional to the extent of the mismatching adopted.

Contracone seal

One of the key factors that determine the success of an implant-prosthetic rehabilitation is the absence of bacterial infiltration. To achieve this, there must be no spaces between the implant and abutment platforms that could permit the transit of bacteria, which, migrating towards the implant could cause anaerobic proliferation with serious consequences for peri-implant tissues. Sweden & Martina has patented a special micromechanical production process that makes both surfaces resting against each other perfectly conical. This creates a mechanical barrier that guarantees a peripheral seal that can **limit bacterial penetration** and protect peri-implant tissues against possible inflammation.

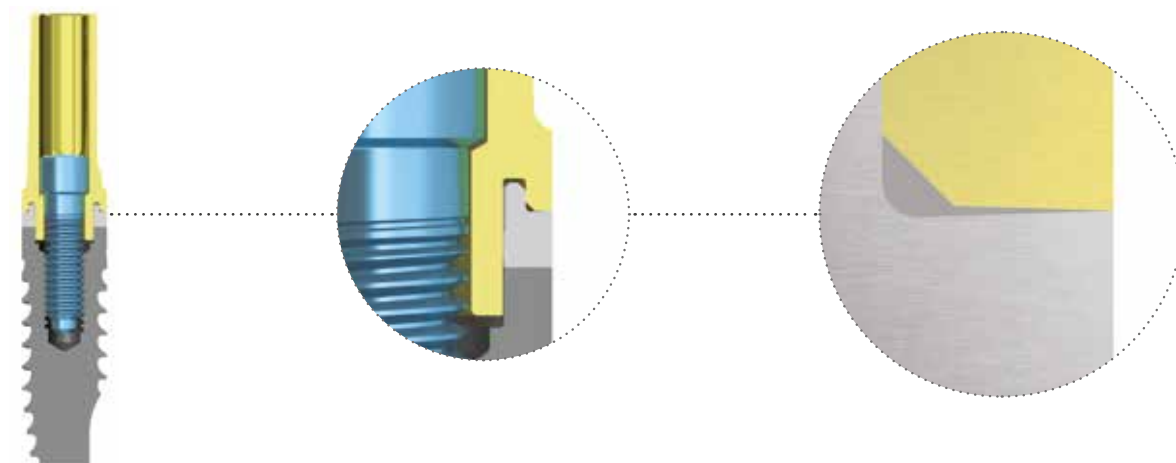

*Contracone seal on
Premium Kohno implant*

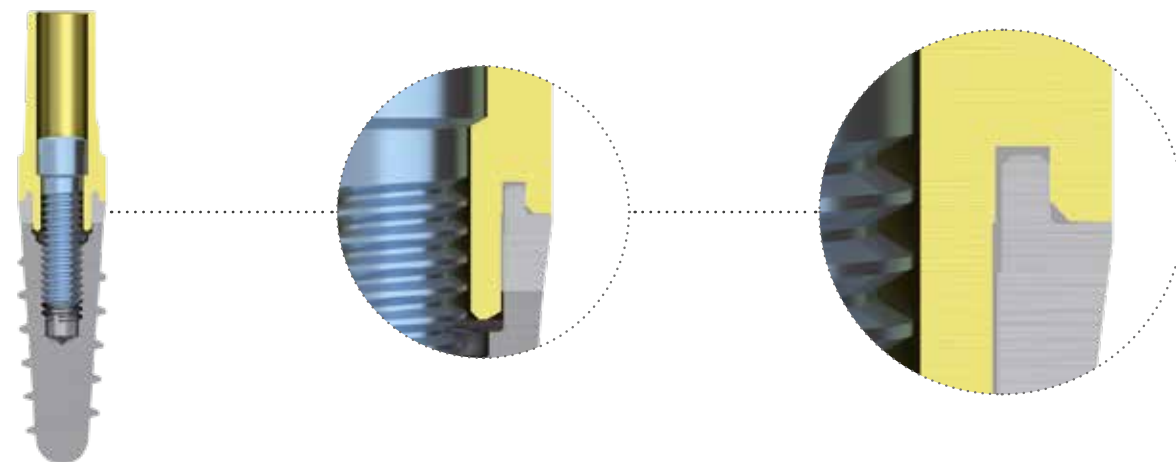

*Contracone seal on
Shelta implant*

Canullo L., Peñarrocha-Oltra D., Soldini C., Mazzocco F., Peñarrocha M.A., Covani U.

Microbiological assessment of the implant-abutment interface in different connections: cross-sectional study after 5 years of functional loading



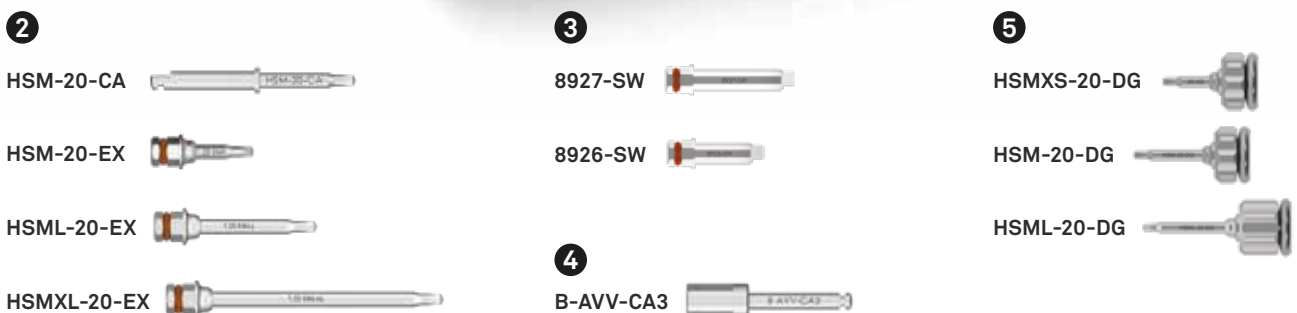
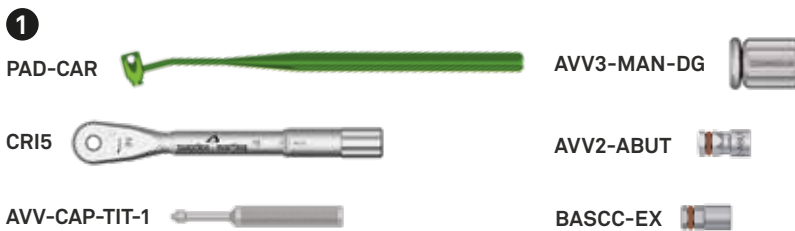

Clin. Oral Impl. Res. 00, 2014, 1–9 doi: 10.1111/clr.12383.

Screw Kit

The Sweden & Martina Screw Kit is a practical set containing the drivers necessary for the prosthetic phases of Premium, Kohno and Shelta implants, for the various prosthetic solutions: standard posts, abutments, P.A.D. prostheses, Locator abutments, ball attachments and their respective retention caps. In addition to manual and contra-angle handpiece drivers, the Screw Kit also includes a carrier for transporting angled P.A.D. abutments. The kit also includes a torque control ratchet along with drivers that have a specific connection to prosthetic components that do not use the standard hex driver, together with a torque-control ratchet. Small and easily transportable, the kit makes it possible to manage the post-surgical prosthetic rehabilitation phase simply and rapidly.



Note: to guarantee the maximum duration of surgical instruments, it is advisable to follow the recommended cleaning and sterilization procedures.

description	code
Complete Screw Kit	<p>ZSCREW</p> 
Instrument tray for Screw Kit	<p>SCREW-TRAY</p> 
Kit with 5 spare silicone supports for surgical trays, for drills or instruments with shank for contra-angle handpiece	<p>GROMMET-CA-1</p> 
Kit with 5 spare silicone supports for surgical trays, for instruments with a hexagonal connection	<p>GROMMET-CA-2</p> 

Important warning

Some of the instruments necessary for prosthetic protocols may also be included in surgical kits. Please consult the respective catalogues for details on the updated contents of these kits.

Drivers for fixation screws

All made of steel for surgical use.

All drivers have the same tip design, and screwdrivers are therefore interchangeable.

Drivers differ in their total length and can be one-piece manual models, with an incorporated knob for easy gripping, fitted with a hexagonal connector compatible with the ratchet or with shank for contra-angle handpiece.

Regular checks must be made to ensure that this function has not been impaired due to wear on the tip.

Important warning

Excessive torque may strip the wells of the fixation screws and wear away the edges of screwdrivers, causing intraoperative or prosthetic complications that may even be serious. The recommended torque values for the tightening of the various components are summarized in this chart

surgical cover screws, transgingival healing abutments	(manually) 8-10 Ncm
all prosthetic screws	20-25 Ncm
all prosthetic components screw retained directly onto an implant	25-30 Ncm
transfer fixation screws	(manually) 8-10 Ncm

Given the importance of tightening torques, it is advisable to always use drivers with a hexagonal connector, controlling the torque applied using the ratchet. To facilitate the engagement of screws or other threaded parts of prosthetic components, screwing operations can however be started with manual drivers.

Driver for contra-angle handpiece

Both Screw Kits and surgical kits contain a driver with a shank for a contra-angle handpiece, an extremely practical accessory in both surgical and prosthetic phases when used with a micromotor with torque control, or a right angle manual driver with torque control. This driver can be used only to tighten posts with a screw hole no longer than 11.00 mm.

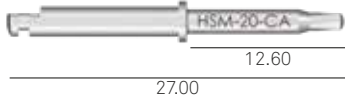
description	code
Driver with shank for contra-angle handpiece	<p>HSM-20-CA</p> 

Surgical screwdrivers

Their design makes them extremely practical during surgical phases and when uncovering and handling transgingival healing abutments. Surgical screwdrivers must not be used when working with definitive prostheses, as they do not allow tightening torque to be controlled. Some of these drivers are also included in the surgical kits of the Premium, Kohno and Shelta systems. Please refer to the catalogues and surgical manuals of the single systems for full details. One-piece drivers are available in the Screw Kit in the following lengths.

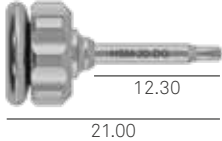
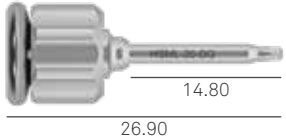
description	code
Driver for tap screws and fixation screws, digital, extra-short	HSMXS-20-DG 
Driver for tap screws and fixation screws, digital, short	HSM-20-DG 
Driver for tap screws and fixation screws, digital, long	HSML-20-DG 

Important warning

It is advisable to pass a safety thread through the hole provided on the top of the knob to prevent it being dropped.

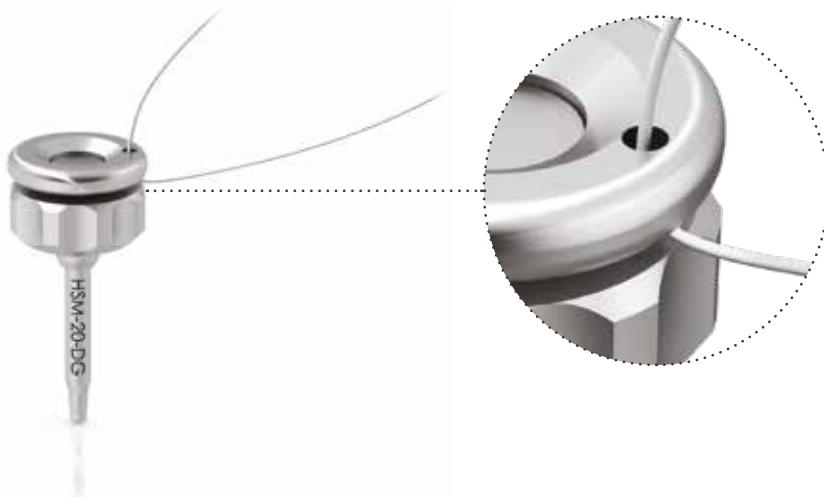

Prosthetic screwdrivers that can be used with the dynamometric key

Drivers with an upper hexagonal connector are designed for use with the torque-control ratchet to provide torque control. The Screw Kit includes short, long and extra-long versions, and this latter is for use when the screw hole inside posts is longer than 13.00 mm. Some of these drivers are also included in the surgical kits of the Premium, Kohno and Shelta systems. Please refer to the catalogues and surgical manuals of the single systems for full details.

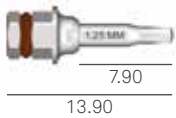
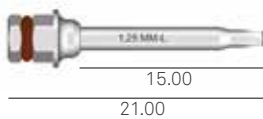
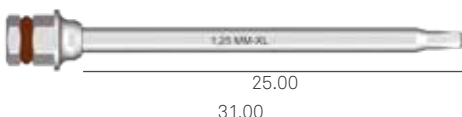
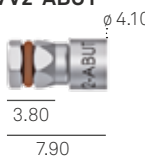
description	code
Driver for connecting screws, with hexagonal connector for dynamometric key or hand knob, short	<p>HSM-20-EX</p> 
Driver for connecting screws, with hexagonal connector for dynamometric key or hand knob, long	<p>HSML-20-EX</p> 
Driver for connecting screws, with hexagonal connector for dynamometric key or hand knob, extra-long	<p>HSMXL-20-EX</p> 
Driver for standard abutments and for straight P.A.D. abutments, with hexagonal connector for dynamometric key	<p>AVV2-ABUT</p> 

Important warning



All drivers for use with a ratchet have a red polymer O-ring inside the connection hexagon, to ensure adequate grip for instruments and therefore the correct position of components. This O-ring must be checked periodically and replaced when worn or no longer able to ensure the correct grip.

A kit of 5 spare O-rings is available, with order code **ORING180-088**.

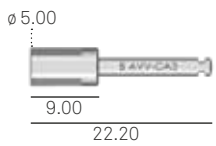

Other instruments

The following instruments are included in the Screw Kit or can be ordered separately. The first two are also included in various surgical kits of the Premium, Kohno and Shelta systems. Please refer to the catalogues and manuals of the single systems for full details.

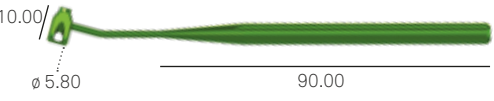
description	code
Adaptor with shank for contra-angle handpiece for instruments with a hexagonal connector	<p>B-AVV-CA3</p> 
Manual knob for drivers, hexagonal keys and manual drivers	<p>AVV3-MAN-DG</p> 
Carrier for transport of angled P.A.D. abutments into the oral cavity, sterilizable and reusable. Must be fixed to abutments with screw PAD-VTRAL-140	<p>PAD-CAR</p> 

The BPM-15 extension, which may be useful in some clinical situations, is not included in the Screw Kit, but can be ordered separately, and is included in the surgical kits of the Premium, Kohno and Shelta systems.

Please refer to the catalogues and manuals of the single systems for full details.

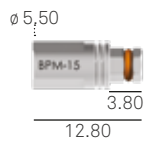
description	code
Extension for hexagonal keys, drivers and manual drivers, with hexagonal connector for torque-control ratchet	<p>BPM-15</p> 

CRI5-KIT torque-control ratchet

The surgical kit of the implant system includes a special ratchet (CRI5-KIT), together with an adjustment key that can be used to rapidly turn the torque adjustment sleeve, and a gel lubricant for maintenance. The ratchet can be used with torque regulations from 10 to 70 Ncm, or in a locked position without torque control. When using the prosthetic ratchet to tighten screws, reference must be made to the torque values indicated on page 207. The CRI5 ratchet is a multipurpose instrument that can be dismantled, and it is supplied as nonsterile.

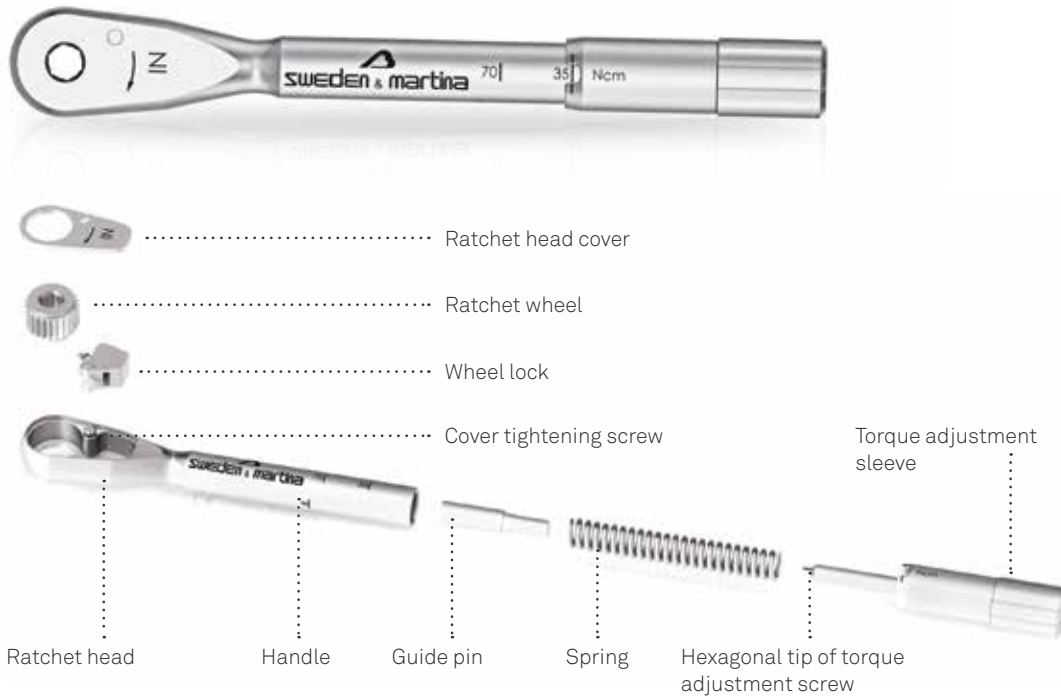

Every time this instrument is used, it must first be cleaned and sterilized, following the instructions on page 209. Adequate maintenance, carried out scrupulously following all steps indicated for dismantling and reassembly of the instrument during cleaning operations, is essential for its correct use and to prolong its lifespan. Personnel using this instrument must be suitably trained, and must have read the instructions given in this manual before proceeding with any operations whatsoever with it. After sterilization, the ratchet is ready for use. It must be tested for correct assembly and operation every time it is used, whether for surgical procedures or for prosthetic procedures.

Torque is adjusted by aligning the marking for the desired torque in the circular opening of the handle. The "IN" arrow on the head when seen from above indicates the position of the ratchet that allows screws to be tightened. The "OUT" arrow on the head when seen from above indicates the position of the ratchet that allows screws to be loosened. A position of unlimited torque can be obtained by setting the torque adjustment device to the notch marked "R" on the ratchet handle.



The torque adjustment sleeve can be tightened and slackened manually, but these operations can be carried out more rapidly using the hexagonal key included in the kit, which allows it to be turned more quickly. The personnel responsible for the use and maintenance of this dental instrument must check it for possible signs of deterioration of the tightening, insertion and torque mechanisms. The single components of the ratchet are not interchangeable, and it is not possible to use a component from one ratchet to replace a component on another, because every ratchet is INDIVIDUALLY calibrated. If a component is lost, always return the entire instrument to Sweden & Martina for all necessary repairs. Components for the assembly of the ratchet are not sold individually. Failure to respect the instructions provided may cause maintenance problems and may also affect prosthesis stability.



Important warning

Torque is always adjusted by tightening/slackening the sleeve at the end of the instrument handle. Torque must always be adjusted upwards, starting from a value lower than that required and tightening the adjustment sleeve in a clockwise direction until the desired value is reached.

This means that if a torque value lower than that used previously is to be set, the adjustment sleeve must be slackened by a minimum of two whole turns beneath the new torque value required, and then tightened again in a clockwise direction to the desired value.



To adjust torque upwards, turn the adjustment sleeve in a clockwise direction.

To adjust torque downwards to a value lower than that used previously, turn the adjustment sleeve in an anticlockwise direction until it is a minimum of two whole turns below the required value. Then tighten it in a clockwise direction until the desired torque value is reached.

Techniques for taking impressions and making models

The correct taking of impressions is the key to success in any implant-prosthetic treatment plan, because if information with as few errors as possible is sent to the laboratory, this makes it possible to save working time and above all to produce prostheses without internal stresses that do not exert undesired strain on implants.

Impressions can be taken at various moments of surgery, depending on the adopted protocol.

Impressions can be taken on Premium, Kohno and Shelta implants with three different protocols:

- open tray with Pick-up transfer;
- closed tray with closed tray transfer;
- closed tray with Pull-up transfer.

Pick-up transfer: the design of the upper section guarantees excellent retention and therefore extremely stable fixation in the impression

Closed tray transfer: a flat face makes it possible to rapidly reposition the transfers in the impression

Pull-up transfer: the connection with tabs clicks into the hexagonal implant connection, without being screw retained

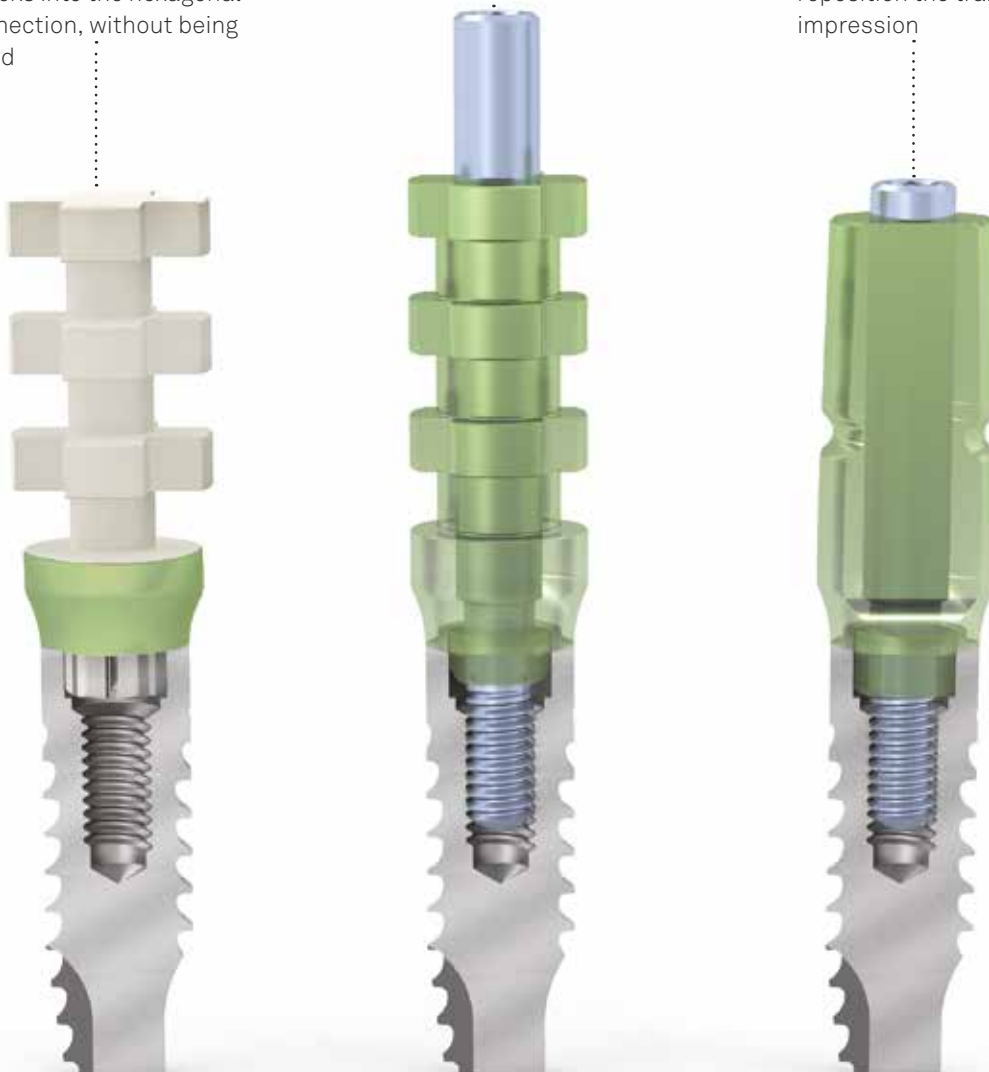

In addition to these possibilities, some prosthetic protocols with special components also envisage the transfer onto the laboratory model not of the implant connection, but instead of the intermediate prosthetic platforms. Therefore, specific transfers and analogs are available: consult the different protocols of use for the specific instructions.







Important warning

It is advisable to always use new transfers and analogs for all cases, so as to guarantee maximum coupling precision at the level of the connection. Transfers and analogs used more than once reciprocally deform the walls of the respective hexagons, transferring errors to impressions that can generate stresses in prostheses which are then transferred to implants and can compromise satisfactory clinical outcomes, above all in the case of multiple structures.

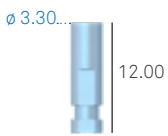
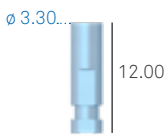
Analogs

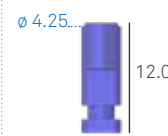
Components for impressions and for the production of models are manufactured with the same machines used to make implants, ensuring the same high level of precision for tolerances and for the accurate reproduction of clinical situations. Analogs are anodized following a colour code, making it easier to recognize implant diameters and simplifying laboratory work.

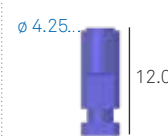

implant ø	3.30	3.80	4.25	5.00	6.00
Analogs for Premium Kohno implants 	A-ANA-330 	A-ANA-380 	A-ANA-425 	A-ANA-500 	A-ANA-600 
Analogs for Shelta implants	-	Use A-ANA-380	SH-ANA-425 	SH-ANA-500 	SH-ANA-600 

See technical characteristics of Gr. 5 titanium on page 196.

Open tray impression

The open tray impression requires the use of a personalized impression tray, made in a laboratory on a preliminary model with access apertures for the transfer screws at positions corresponding to the implants. It is advisable to use the short driver with a hexagonal connector for ratchet HSM-20-EX, or extra-short manual driver HSMXS-20-DG, both specifically developed to reduce the vertical space required and to facilitate screwing and unscrewing torque-control operations for the transfer screws in the oral cavity.







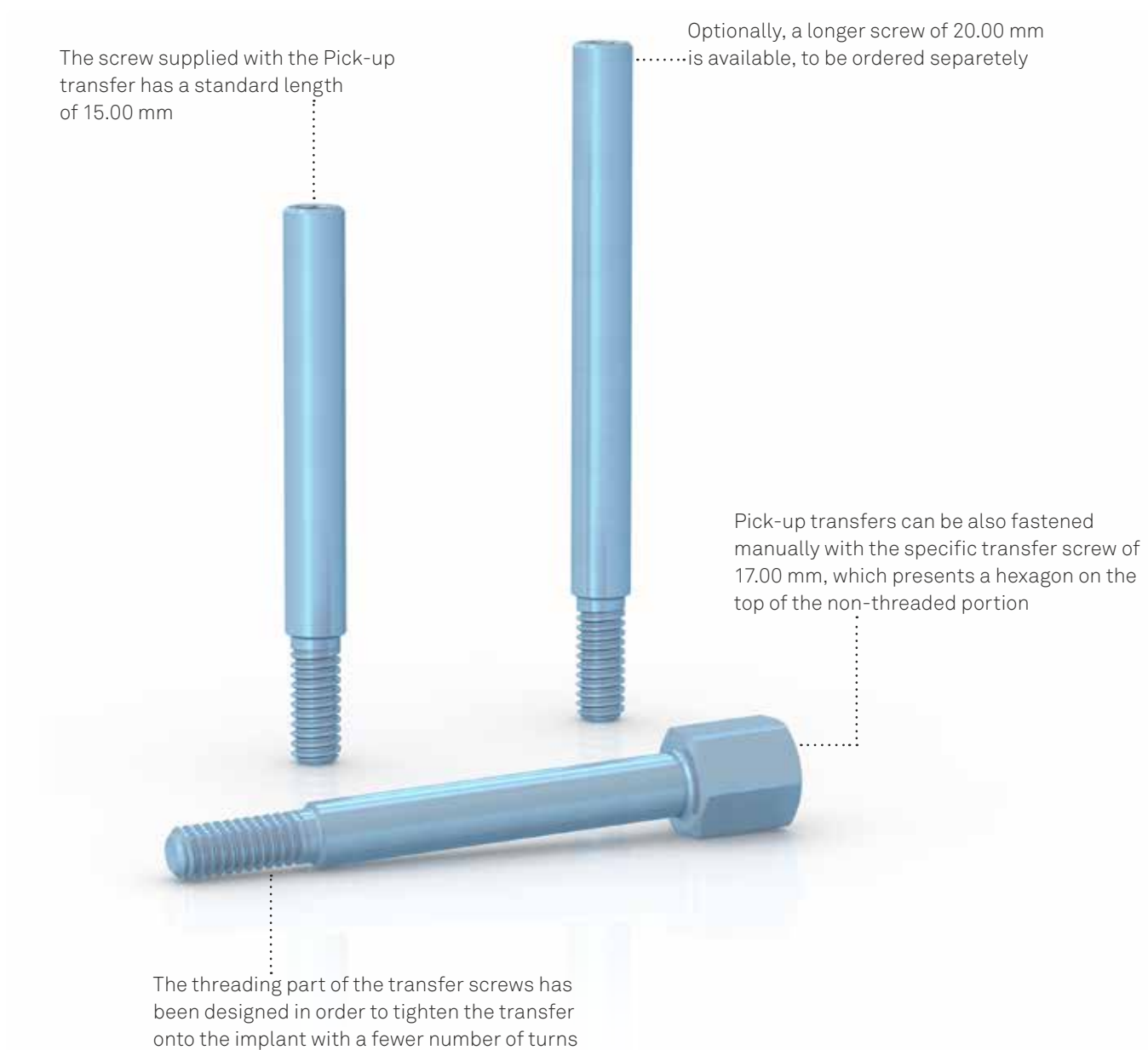





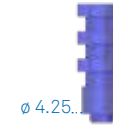

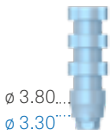
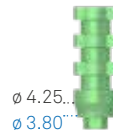
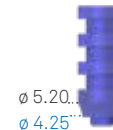
Pick-up transfer screws

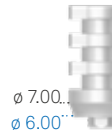
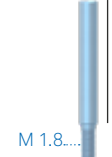
For the open tray impression technique several types of Pick-up transfer screws of different length are available, to be used both with the screwdrivers of the HSM series and with the screwdrivers for manual screwing.

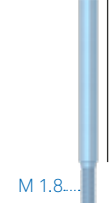

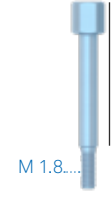



Pick-up transfers for Premium Kohno implants

prosthetic component ϕ	3.30	3.80	4.25	5.00	6.00
for implants	Premium 3.30 - 3.80 Kohno 3.80	Premium 3.80 Kohno 3.80	Premium 4.25 Kohno 4.25	Premium 5.00 Kohno 5.00	Kohno 6.00
Pick-up transfer Straight emergence Fixation screw included	A-TRA-330  ϕ 3.30... 12.00	A-TRA-380  ϕ 3.80... 12.00	A-TRA-425  ϕ 4.25... 12.00	A-TRA-500  ϕ 5.00... 12.00	-
Pick-up transfer Anatomical emergence Fixation screw included	A-TRAR-330  ϕ 3.80... ϕ 3.30... 12.00	A-TRAR-380  ϕ 4.25... ϕ 3.80... 12.00	A-TRAR-425  ϕ 5.20... ϕ 4.25... 12.00	A-TRAR-500  ϕ 6.00... ϕ 5.00... 12.00	A-TRAR-600  ϕ 7.00... ϕ 6.00... 12.00
Fixation screw for Pick-up transfer Supplied with the transfers, it can also be ordered separately	VTRA2-180-15  M 1.8... 15.00	Use VTRA2-180-15	VTRA2-200-15  M 2.0... 15.00	Use VTRA2-200-15	Use VTRA2-200-15
Fixation screw for Pick-up transfer Not supplied with transfer, available separately	VTRA2-180-20  M 1.8... 20.00	Use VTRA2-180-20	VTRA2-200-20  M 2.0... 20.00	Use VTRA2-200-20	Use VTRA2-200-20
Fixation screw for Pick-up transfer For manual screwing Not supplied with transfer, available separately	VTRA2-180-MAN  M 1.8... 17.00	Use VTRA2-180-MAN	VTRA2-200-MAN  M 2.0... 17.00	Use VTRA2-200-MAN	Use VTRA2-200-MAN

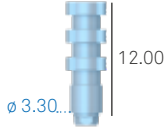
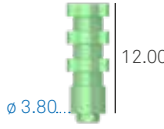
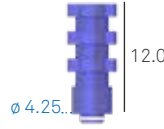
Recommended torque for transfer screws: 8-10 Ncm.

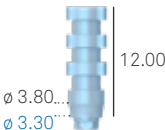
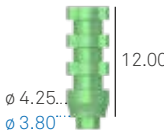
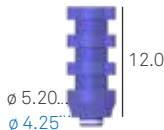
Pick-up transfers for Shelta im plants

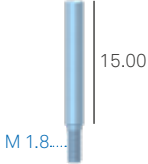
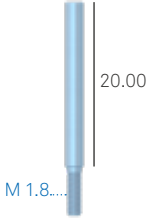
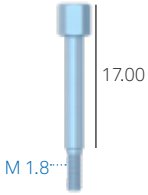
prosthetic component \emptyset	3.30	3.80	4.25	5.00
for implants	Shelta 3.80	Shelta 3.80 - 4.25 5.00 - 6.00	Shelta 4.25 - 5.00 - 6.00	Shelta 5.00 - 6.00
Pick-up transfer Straight emergence Fixation screw included	A-TRA-330  \emptyset 3.30... 12.00	A-TRA-380  \emptyset 3.80... 12.00	AS-TRA-425  \emptyset 4.25... 12.00	AS-TRA-500  \emptyset 5.00... 12.00
Pick-up transfer Anatomical emergence Fixation screw included	A-TRAR-330  \emptyset 3.80... \emptyset 3.30... 12.00	A-TRAR-380  \emptyset 4.25... \emptyset 3.80... 12.00	AS-TRAR-425  \emptyset 5.20... \emptyset 4.25... 12.00	AS-TRAR-500  \emptyset 6.00... \emptyset 5.00... 12.00
Fixation screw for Pick-up transfer Supplied with the transfers, it can also be ordered separately	VTRA2-180-15  M 1.8... 15.00	Use VTRA2-180-15	Use VTRA2-180-15	Use VTRA2-180-15
Fixation screw for Pick-up transfer Not supplied with transfer, available separately	VTRA2-180-20  M 1.8... 20.00	Use VTRA2-180-20	Use VTRA2-180-20	Use VTRA2-180-20
Fixation screw for Pick-up transfer For manual screwing Not supplied with transfer, available separately	VTRA2-180-MAN  M 1.8... 17.00	Use VTRA2-180-MAN	Use VTRA2-180-MAN	Use VTRA2-180-MAN

Recommended torque for transfer screws: 8-10 Ncm.

In case of adoption of a Platform Switching protocol from the very beginning of the treatment using surgical cover screws with a smaller diameter, it may be necessary to take the impression with a transfer of the same size of the surgical cover screw used.

Open tray impression with Pick-up transfer – single crown

Expose the implant connection if a protocol with a double surgical phase has been adopted, or remove the healing abutment.



Tighten the Pick-up transfer with the specific supplied screw and the most suitable screwdriver from the HSM series, without exceeding a torque of 8–10 Ncm (**img. A**), or tighten the Pick-up transfer with the screw for manual screwing, available optionally (**img. B**).

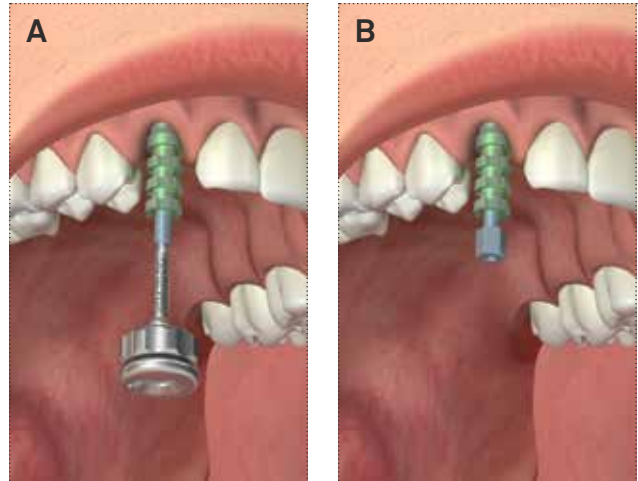

Check that the personalized tray, when placed in the mouth, contains the entire height of the transfer inside its walls, and that the summit of the transfer screw emerges for a suitable length from the respective hole in the tray. If necessary, the transfer can be shortened by one or two notches. Inject a precision impression material (i.e. SKY IMPLANT LIGHT, code SKY14) around the transfer.



Fill the impression tray with a more consistent impression material (i.e. SKY IMPLANT ONEMIX-ED, code SKY08) over the entire arch. Then position the tray *in situ* and wait for the hardening times as indicated by the instructions.

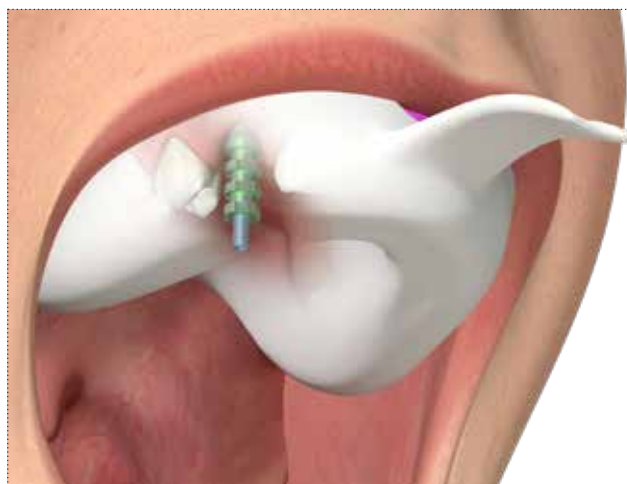

Unscrew the transfer screw and remove it from the impression, to prevent it from accidentally falling into the patient's mouth when the impression tray is removed. Remove the tray. The Pick-up transfer remains incorporated in the impression.



Screw the laboratory analog onto the transfer using the transfer screw, replaced in the hole left by it in the impression material. The recommended torque is 8–10 Ncm. Develop the model as usual.

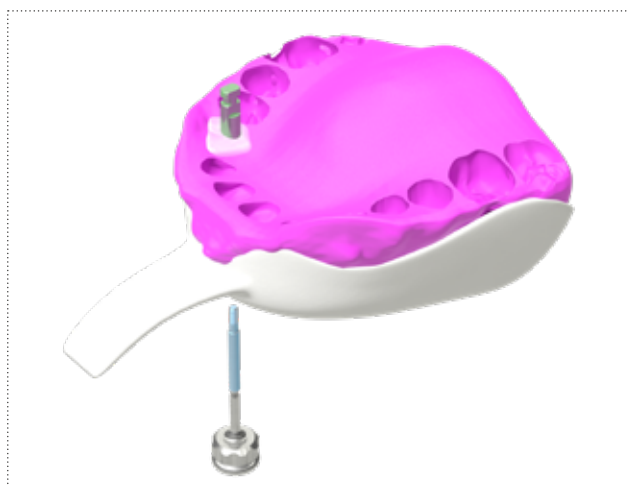

Open tray impression with Pick-up transfer – multiple

Expose the implant connections if a protocol with a double surgical phase has been adopted, or remove the healing abutments.



Tighten the Pick-up transfers with the specific screw supplied and the most suitable screwdriver from the HSM series, without exceeding a torque of 8–10 Ncm (**img. A**), or tighten the Pick-up transfers with the screw for manual screwing, available optionally (**img. B**).

If desired, fix the transfers together with wire and resin or composite, and wait for polymerization to be completed, as indicated by the manufacturer (e.g. SUN resin, code SUN-A2 or SUN-A3).

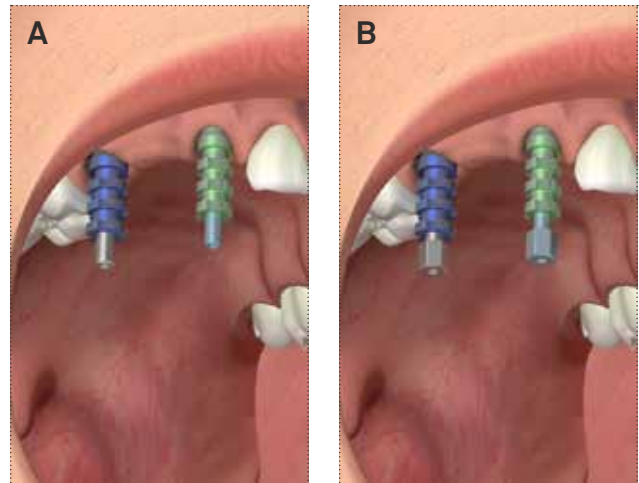

Check that the personalized tray, when placed in the mouth, contains the entire height of the transfers inside its walls, and that the summit of the transfer screws emerges for a suitable length from the respective hole in the tray. If necessary, the transfers can be shortened by one or two notches.

Inject a precision impression material (i.e. SKY IMPLANT LIGHT, code SKY14) around the transfers.



Fill the impression tray with a more consistent impression material (i.e. SKY IMPLANT ONEMIX-ED, code SKY08) over the entire arch. Then position the tray *in situ* and wait for the hardening times as indicated by the instructions.

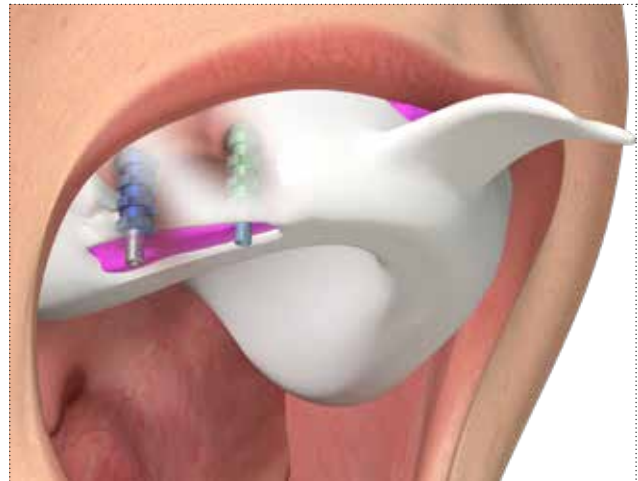

Unscrew the transfer screws and remove them from the impression, to prevent them from accidentally falling into the patient's mouth when the impression tray is removed. Remove the tray. The Pick-up transfers remain incorporated in the impression.

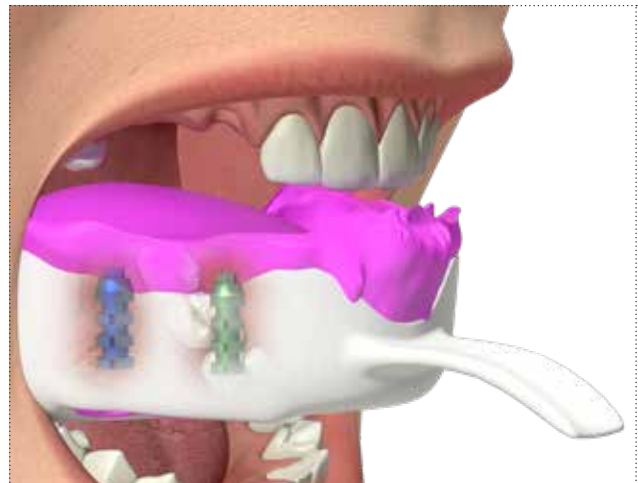

Screw the laboratory analogs onto the transfers using the transfer screws, replaced in the holes left by them in the impression material.
The recommended torque is 8–10 Ncm.
Develop the model as usual.



Closed tray impression

The closed tray transfers are made Gr. 5 titanium, anodized according to the colour code of the corresponding connection platform to facilitate the repositioning of the analog during the laboratory phases.





The closed tray transfers present a wide repositioning face ensuring a precise impression. They have an anatomical emergence that exactly repeats that of the transgingival healing abutments. For diameter 3.30 a version with straight emergence is also available, very useful for single rehabilitations in the front sector, where it is usually more practical to use components with limited bulk.

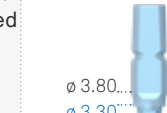

Closed tray transfers for Premium Kohno implants

prosthetic component \varnothing	3.30	3.80	4.25	5.00	6.00
for implants	Premium 3.30 - 3.80 Kohno 3.80	Premium 3.80 Kohno 3.80	Premium 4.25 Kohno 4.25	Premium 5.00 Kohno 5.00	Kohno 6.00
Closed tray transfer Straight emergence Fixation screw included	A-TRAS-330  \varnothing 3.30... 11.00	-	-	-	-
Closed tray transfer Anatomical emergence Fixation screw included	A-TRARS-330  \varnothing 3.80... \varnothing 3.30... 11.00	A-TRARS-380  \varnothing 4.25... \varnothing 3.80... 11.00	A-TRARS-425  \varnothing 5.20... \varnothing 4.25... 11.00	A-TRARS-500  \varnothing 6.00... \varnothing 5.00... 11.00	A-TRARS-600  \varnothing 7.00... \varnothing 6.00... 11.00
Fixation screw for closed tray transfer Supplied with the transfers, it can also be ordered separately	VTRA2-180-10  M 1.8... 10.00	Use VTRA2-180-10	VTRA2-200-10  M 2.0... 10.00	Use VTRA2-200-10	Use VTRA2-200-10

Closed tray transfers for Shelta implants

prosthetic component \varnothing	3.30	3.80	4.25	5.00
for implants	Shelta 3.80	Shelta 3.80 - 4.25 - 5.00	Shelta 4.25 - 5.00 - 6.00	Shelta 5.00 - 6.00
Closed tray transfer Straight emergence Fixation screw included	A-TRAS-330  \varnothing 3.30... 11.00	-	-	-
Closed tray transfer Anatomical emergence Fixation screw included	A-TRARS-330  \varnothing 3.80... \varnothing 3.30... 11.00	A-TRARS-380  \varnothing 4.25... \varnothing 3.80... 11.00	AS-TRARS-425  \varnothing 5.20... \varnothing 4.25... 11.00	AS-TRARS-500  \varnothing 6.00... \varnothing 5.00... 11.00
Fixation screw for closed tray transfer Supplied with the transfers, it can also be ordered separately	VTRA2-180-10  M 1.8... 10.00	Use VTRA2-180-10	Use VTRA2-180-10	Use VTRA2-180-10

Recommended torque for transfer screws: 8-10 Ncm.

In case of adoption of a Platform Switching protocol from the very beginning of the treatment using surgical cover screws with a smaller diameter, it may be necessary to take the impression with a transfer of the same size of the surgical cover screw used.

See technical characteristics of Gr. 5 titanium on page 196.

Closed tray impression with closed tray transfer – single crown

Expose the implant connection if a protocol with a double surgical phase has been adopted, or remove the healing abutment.



Tighten the closed tray transfer with the specific screw supplied and the most suitable screwdriver from the HSM series, without exceeding a torque of 8–10 Ncm. Close the screw hole with wax to preserve it from the entrance of impression material, removing the exceeding wax in order to not compromise the precision of the impression.

Note: The surgical screwdriver for surgical cover screws and fixation screws is available with several shank lengths to satisfy different clinical needs. A version with a hexagonal connector for a torque-control ratchet is also available, or with a shank for a ratchet. See page 28 for technical details on these screwdrivers.



Choose a tray of suitable dimensions, so that the height of the transfer is contained inside the walls of the impression tray.

Inject a precision impression material (i.e. SKY IMPLANT LIGHT, code SKY14) around the transfer and fill the impression tray with a more consistent impression material (i.e. SKY IMPLANT ONEMIX-ED, code SKY08) over the entire arch.



Then position the tray *in situ* and wait for the hardening times as indicated by the instructions.



Remove the tray: the closed tray transfer remains tightened to the implant. Remove the wax from the head of the screw and unscrew it to remove the transfer.



Screw the laboratory analog onto the transfer using the transfer screw and reposition it in the hole left by the impression material, coupling correctly the flat face that acts like a repositioning index. The recommended torque is 8-10 Ncm. Develop the model as usual.

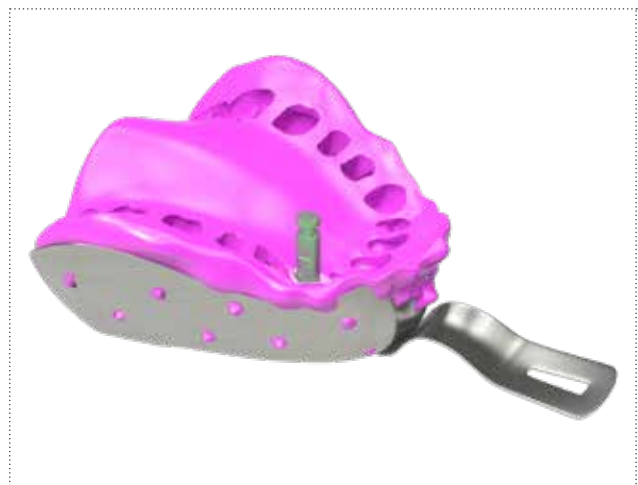

Closed tray impression with closed tray transfer – multiple

Expose the implant connections if a protocol with a double surgical phase has been adopted, or remove the healing abutments.



Tighten the closed tray transfers with the specific screw supplied and the most suitable screwdriver from the HSM series, without exceeding a torque of 8–10 Ncm. Close the screws hole with wax to preserve them from the entrance of impression material, removing the exceeding wax in order to not compromise the precision of the impression.

Note: The surgical screwdriver for surgical cover screws and fixation screws is available with several shank lengths to satisfy different clinical needs. A version with a hexagonal connector for a torque-control ratchet is also available, or with a shank for a ratchet. See page 28 for technical details on these screwdrivers.



Choose a tray of suitable dimensions, so that the height of the transfers is contained inside the walls of the impression tray.

Inject a precision impression material (i.e. SKY IMPLANT LIGHT, code SKY14) around the transfers and fill the impression tray with a more consistent impression material (i.e. SKY IMPLANT ONEMIX-ED, code SKY08) over the entire arch.



Then position the tray *in situ* and wait for the hardening times as indicated by the instructions.



Remove the tray: the closed tray transfers remain tightened to the implants. Remove the wax from the head of the screws and unscrew them to remove the transfers.

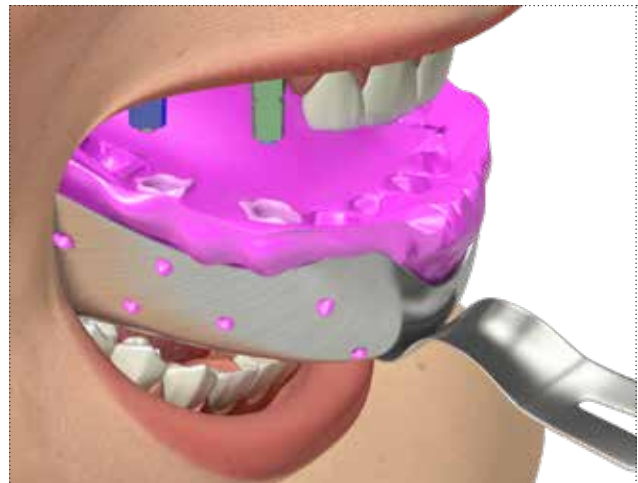

Screw the laboratory analogs onto the transfers using the transfer screws and reposition them in the hole left by the impression material, coupling correctly the flat face that acts like a repositioning index. The recommended torque is 8-10 Ncm. Develop the model as usual.



Pull-up impression

The Pull-up technique has been developed by Sweden & Martina to make it easier to take impressions in cases in which the limited oral opening of the patient makes it difficult to screw in and unscrew transfer screws. Pull-up transfers are made completely of PEEK with a titanium ring around the base, anodized according to the colour code of the reference platform, which facilitates the recognition and the verification of the proper seating in the implant platform with an x-ray.

Pull-up transfers have a connection shaped in a way that allows them to be clicked inside the connection hexagons without needing to be fixed with a screw, but instead exploiting the stabilization capacity of the COLLEX connection. They are extremely practical for taking positioning impressions, for example for the production of a model on which the individual tray can be developed, since they are easy and quick to use.

They can also be used in combination with Pick-up transfers, for example in distal sectors, in situations in which the mesial elements have sufficient space for screwing and unscrewing operations on the transfer screw, while the distal elements present anatomical difficulties. They are the ideal solution for taking quick impressions between converging implants because they can be easily shortened by using a disk blade to remove one or two of the vertical modules, or to remove portions of horizontal retention arms that may cause interference.

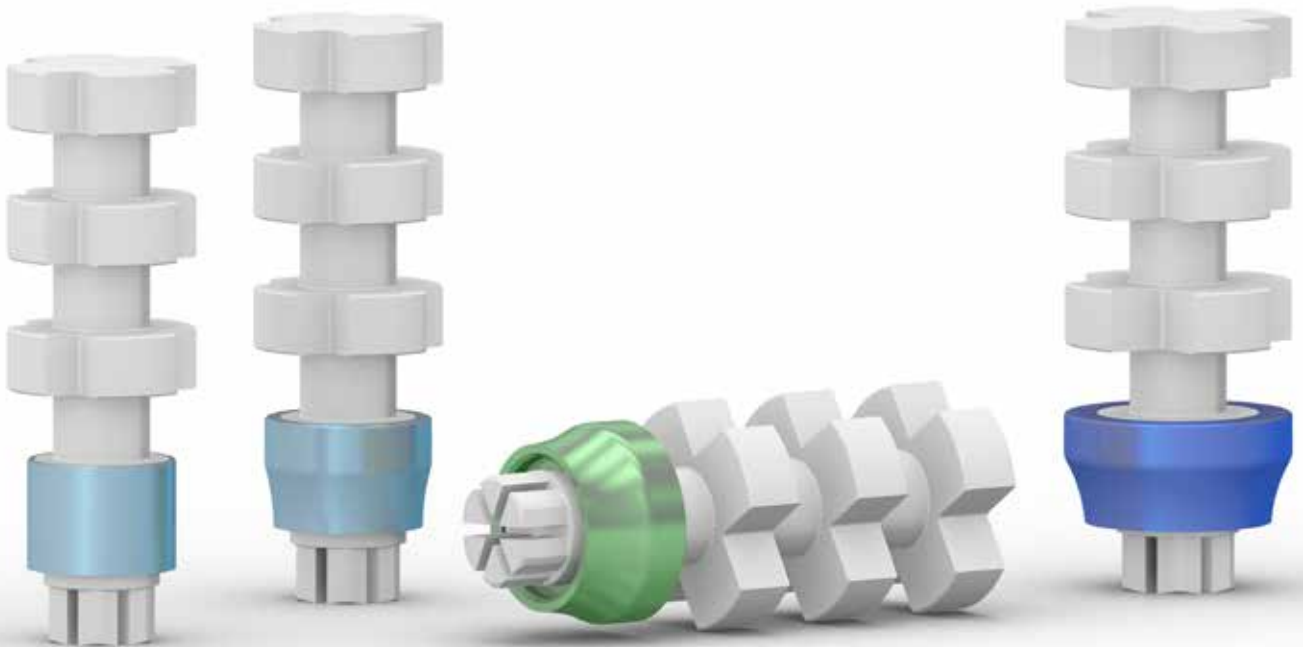

Pull-up transfers for Premium Kohno implants

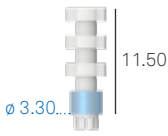
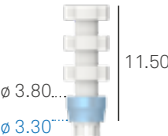
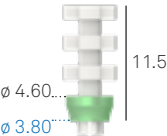
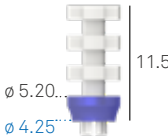
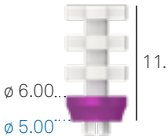
prosthetic component \emptyset	3.30	3.80	4.25	5.00
for implants	Premium 3.30 - 3.80 Kohno 3.80	Premium 3.80 Kohno 3.80	Premium 4.25 Kohno 4.25	Premium 5.00 Kohno 5.00 - 6.00
Pull-up transfer in PEEK and Gr. 5 titanium ring Straight emergence	A-TRAP-330 	-	-	-
Pull-up transfer in PEEK and Gr. 5 titanium ring Anatomical emergence	A-TRARP-330 	A-TRARP-380 	A-TRARP-425 	A-TRARP-500 

Pull-up transfers for Shelta implants

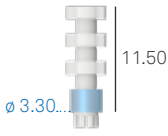
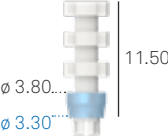
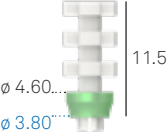
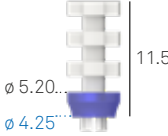
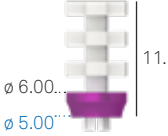
prosthetic component \emptyset	3.30	3.80	4.25	5.00
for implants	Shelta 3.80	Shelta 3.80 - 4.25 5.00 - 6.00	Shelta 4.25 - 5.00 - 6.00	Shelta 5.00 - 6.00
Pull-up transfer in PEEK and Gr. 5 titanium ring Straight emergence	A-TRAP-330 	-	-	-
Pull-up transfer in PEEK and Gr. 5 titanium ring Anatomical emergence	A-TRARP-330 	A-TRARP-380 	AS-TRARP-425 	AS-TRARP-500 

In case of adoption of a Platform Switching protocol from the very beginning of the treatment using surgical cover screws with a smaller diameter, it may be necessary to take the impression with a transfer of the same size of the surgical cover screw used.

Important warning

As the pull-up transfers are made of polymer material, to guarantee precision it is recommended to use new transfers for taking each impression.

Impression with Pull-up transfer – single crown

Expose the implant connection if a protocol with a double surgical phase has been adopted, or remove the healing abutment.



Position the Pull-up transfer and fix it by simply applying pressure with the hand, without needing to use instruments. The characteristic click of the transfer tabs indicates that the transfer has been correctly inserted in the implant connection.

Important warning

In case of poor visibility or doubts on complete coupling between the transfer and the implant, carry out a radiographic check. The titanium ring at the base of the transfer makes it visible with an x-ray.



Position the tray and check that the entire height of the transfer is contained inside the walls of the impression tray. Inject a precision impression material (i.e. SKY IMPLANT LIGHT, code SKY14) only around the transfer.

Important warning

If necessary, the height of Pull-up transfer can be reduced by cutting away one or two vertical modules or removing the portions of the horizontal tabs creating interference. The retention of the remaining portion of the transfer in the impression material will be sufficient to ensure that the impression is taken correctly.



Fill the impression tray with a more consistent material (i.e. SKY IMPLANT ONEMIX-ED, code SKY08) along the entire arch. Then position the tray *in situ* and wait for the hardening times as indicated by the instructions.

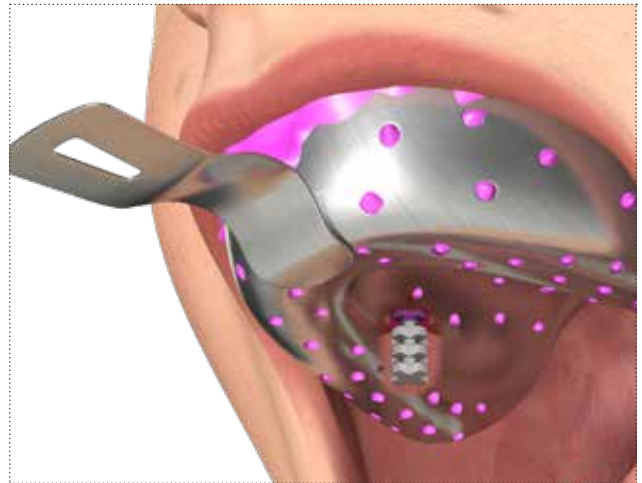

Lift the tray off vertically: the Pull-up transfer will remain incorporated in the impression.

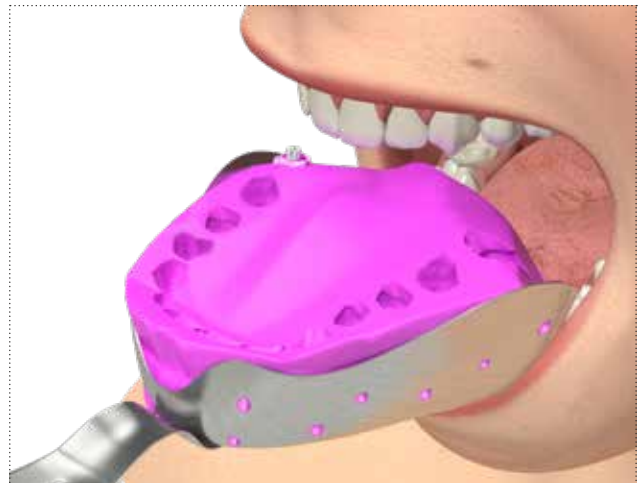

Couple the transfer with a laboratory analog of a corresponding diameter. The characteristic click of the transfer tabs indicates that the analog has been correctly inserted. Develop the preliminary model and create an individual impression tray using normal methods.



Impression with Pull-up transfer – multiple

Expose the implant connections if a protocol with a double surgical phase has been adopted, or remove the healing abutments.



Position the Pull-up transfers and fix them by simply applying pressure with the hand, without needing to use instruments. The characteristic click of the transfer tabs indicates that the transfers have been correctly inserted in the implant connection.

Important warning

In case of poor visibility or doubts on complete coupling between the transfers and the implants, carry out a radiographic check. The titanium ring at the base of the transfers make them visible with an x-ray.



Position the tray and check that the entire height of the transfers is contained inside the walls of the impression tray. Inject a precision impression material (i.e. SKY IMPLANT LIGHT, code SKY14) only around the transfers.

Important warning

If necessary, the height of Pull-up transfers can be reduced by cutting away one or two vertical modules or removing the portions of the horizontal tabs creating interference. The retention of the remaining portion of the transfers in the impression material will be sufficient to ensure that the impression is taken correctly.

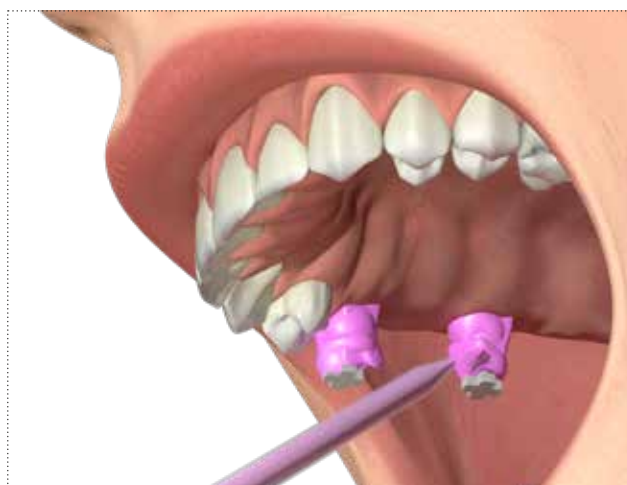

Fill the impression tray with a more consistent material (i.e. SKY IMPLANT ONEMIX-ED, code SKY08) along the entire arch. Then position the tray *in situ* and wait for the hardening times as indicated by the instructions.

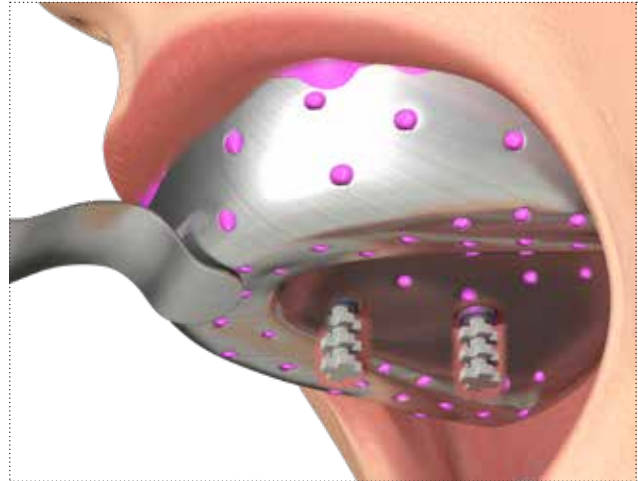

Lift the tray off vertically: the Pull-up transfers will remain incorporated in the impression.

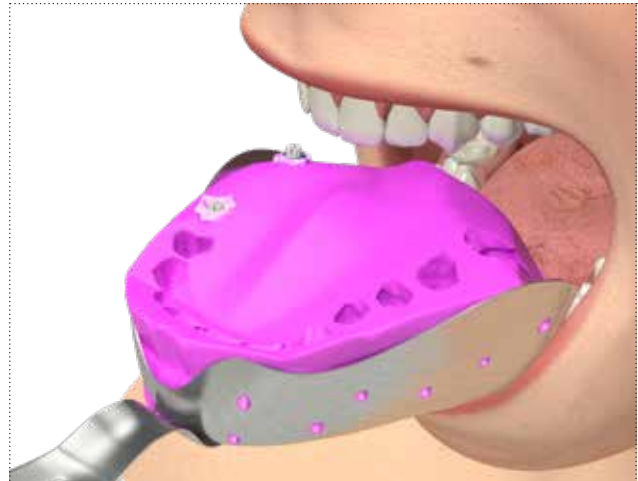

Couple each of the transfers with a laboratory analog of a corresponding diameter. The characteristic click of the transfers tabs indicate that the analogs have been correctly inserted.
Develop the preliminary model and create an individual impression tray using normal methods.



Soft tissues conditioning with healing abutments

To permit the rehabilitation of tissues according to the different anatomical needs of patients, posts with both a straight profile and with an anatomic profile are available, according to the prosthetic protocol adopted.

Healing abutments must be chosen with a transgingival height of one millimetre higher than that of the post to be used for the final rehabilitation, so as to pass through the transgingival portion and to then allow posts to be inserted more easily.

The healing abutments with a straight profile (**img. A**) present a laser marking on one side which reports the platform diameter and the height, the healing abutments with an anatomical profile (**img. B**) present a laser marking on the upper surface reporting the connection diameter, the maximum flare of the healing abutment and the transgingival height.

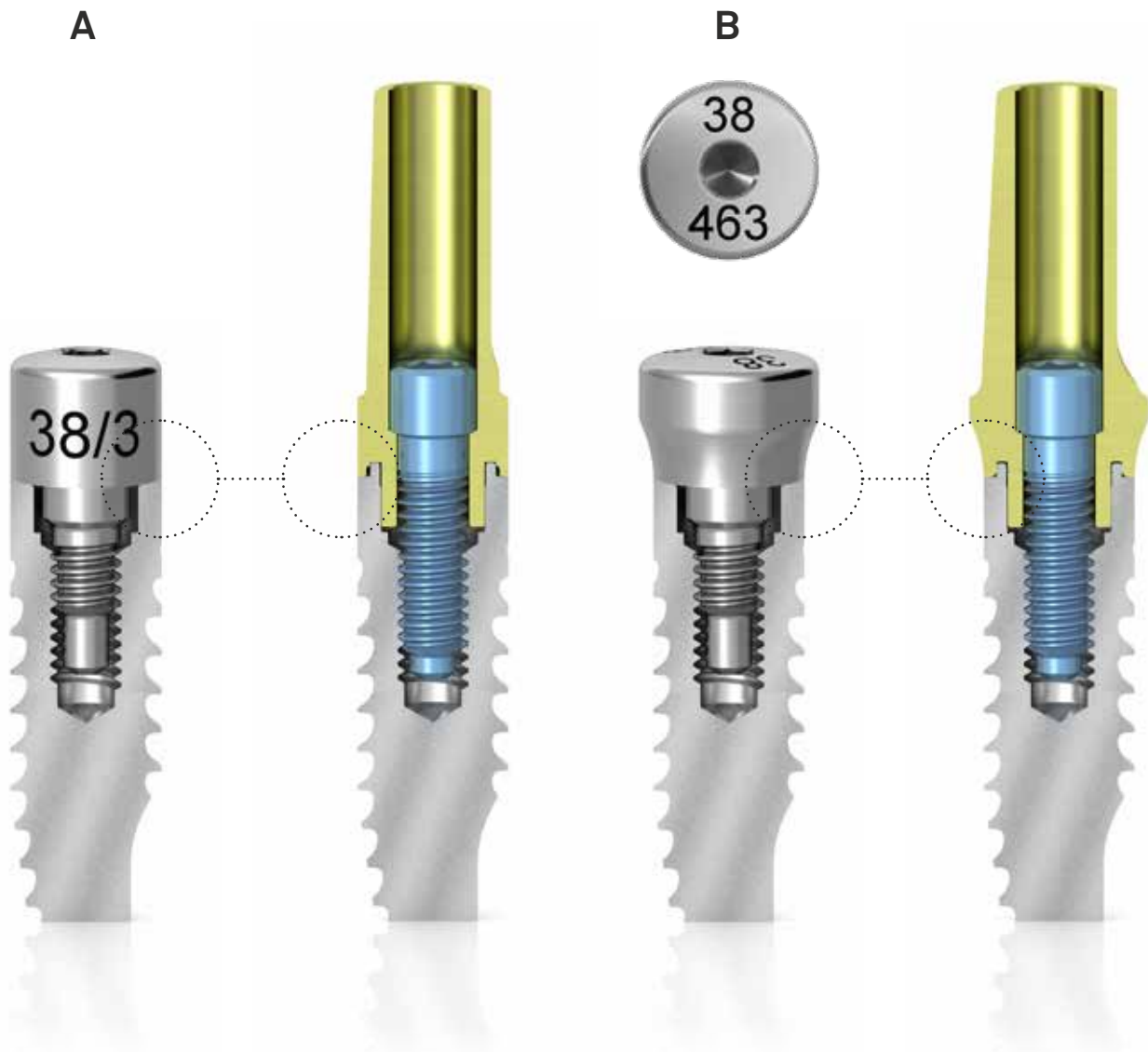















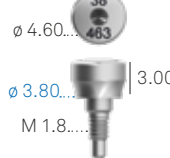

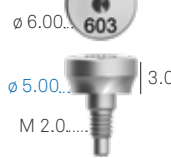
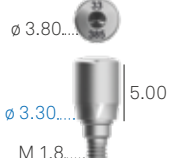
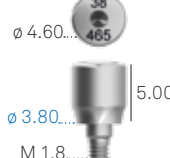
Healing abutments for Premium Kohno implants

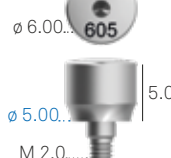
prosthetic component \varnothing	3.30	3.80	4.25	5.00	6.00
for implants	Premium 3.30 - 3.80 Kohno 3.80	Premium 3.80 Kohno 3.80	Premium 4.25 Kohno 4.25	Premium 5.00 Kohno 5.00	Kohno 6.00
Healing abutments Anatomical emergence Transgingival H. 2 mm	A-TMGR-330-2 \varnothing 3.30... 2.00 M 1.8...	A-TMGR-380-2 \varnothing 3.80... 2.00 M 1.8...	A-TMGR-425-2 \varnothing 4.25... 2.00 M 2.0...	A-TMGR-500-2 \varnothing 5.00... 2.00 M 2.0...	A-TMGR-600-2 \varnothing 6.00... 2.00 M 2.0...
Healing abutments Anatomical emergence Transgingival H. 3 mm	A-TMGR-330-3 \varnothing 3.30... 3.00 M 1.8...	A-TMGR-380-3 \varnothing 3.80... 3.00 M 1.8...	A-TMGR-425-3 \varnothing 4.25... 3.00 M 2.0...	A-TMGR-500-3 \varnothing 5.00... 3.00 M 2.0...	A-TMGR-600-3 \varnothing 6.00... 3.00 M 2.0...
Healing abutments Anatomical emergence Transgingival H. 5 mm	A-TMGR-330-5 \varnothing 3.30... 5.00 M 1.8...	A-TMGR-380-5 \varnothing 3.80... 5.00 M 1.8...	A-TMGR-425-5 \varnothing 4.25... 5.00 M 2.0...	A-TMGR-500-5 \varnothing 5.00... 5.00 M 2.0...	A-TMGR-600-5 \varnothing 6.00... 5.00 M 2.0...
Healing abutments Anatomical emergence Transgingival H. 7 mm	-	A-TMGR-380-7 \varnothing 3.80... 7.00 M 1.8...	A-TMGR-425-7 \varnothing 4.25... 7.00 M 2.0...	A-TMGR-500-7 \varnothing 5.00... 7.00 M 2.0...	-
Healing abutments Straight emergence Transgingival H. 2 mm	A-TMG-330-2 \varnothing 3.30... 2.00 M 1.8...	A-TMG-380-2 \varnothing 3.80... 2.00 M 1.8...	A-TMG-425-2 \varnothing 4.25... 2.00 M 2.0...	-	-
Healing abutments Straight emergence Transgingival H. 3 mm	A-TMG-330-3 \varnothing 3.30... 3.00 M 1.8...	A-TMG-380-3 \varnothing 3.80... 3.00 M 1.8...	A-TMG-425-3 \varnothing 4.25... 3.00 M 2.0...	-	-
Healing abutments Straight emergence Transgingival H. 5 mm	A-TMG-330-5 \varnothing 3.30... 5.00 M 1.8...	A-TMG-380-5 \varnothing 3.80... 5.00 M 1.8...	A-TMG-425-5 \varnothing 4.25... 5.00 M 2.0...	A-TMG-500-5 \varnothing 5.00... 5.00 M 2.0...	-

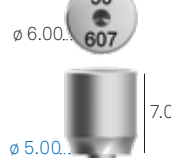
Recommended torque for healing abutments: 8-10 Ncm.

See technical characteristics of Gr. 5 titanium on page 196.

Healing abutments for Shelta implants

prosthetic component \varnothing	3.30	3.80	4.25	5.00
for implants	Shelta 3.80	Shelta 3.80 - 4.25 5.00 - 6.00	Shelta 4.25 - 5.00 - 6.00	Shelta 5.00 - 6.00
Healing abutments Anatomical emergence Transgingival H. 2 mm	A-TMGR-330-2 	A-TMGR-380-2 	AS-TMGR-425-2 	AS-TMGR-500-2 
Healing abutments Anatomical emergence Transgingival H. 3 mm	A-TMGR-330-3 	A-TMGR-380-3 	AS-TMGR-425-3 	AS-TMGR-500-3 
Healing abutments Anatomical emergence Transgingival H. 5 mm	A-TMGR-330-5 	A-TMGR-380-5 	AS-TMGR-425-5 	AS-TMGR-500-5 
Healing abutments Anatomical emergence Transgingival H. 7 mm	-	A-TMGR-380-7 	AS-TMGR-425-7 	AS-TMGR-500-7 
Healing abutments Straight emergence Transgingival H. 2 mm	A-TMG-330-2 	A-TMG-380-2 	-	-
Healing abutments Straight emergence Transgingival H. 3 mm	A-TMG-330-3 	A-TMG-380-3 	-	-
Healing abutments Straight emergence Transgingival H. 5 mm	A-TMG-330-5 	A-TMG-380-5 	-	-

Recommended torque for healing abutments: 8-10 Ncm.
See technical characteristics of Gr. 5 titanium on page 196.

Soft tissues conditioning with healing abutments - single crown

Healing abutment must be inserted using screwdrivers from the HSM series. It is necessary to tighten the healing abutment with the CRI5-KIT, which guarantees the control of the tightening torque of 8–10 Ncm.

Suture the flaps around the healing abutment, respecting the original conformation of the papillae of the adjacent teeth.



During the healing period of the soft tissues, the aesthetics, where necessary, can be maintained luting a Maryland bridge to the adjacent teeth, to avoid applying loads to the healing abutment and consequently to the implant.



Soft tissues conditioning with healing abutments - multiple

It is necessary to tighten the healing abutments with the CRI5-KIT, which guarantees the control of the tightening torque of 8–10 Ncm.

Suture the flaps around the healing abutments.



During the healing period of the soft tissues, the aesthetics, where necessary, can be maintained luting a Maryland bridge to the adjacent teeth, to avoid applying loads to the healing abutments and consequently to the implants.





Soft tissues conditioning with temporary rehabilitations using Simple posts

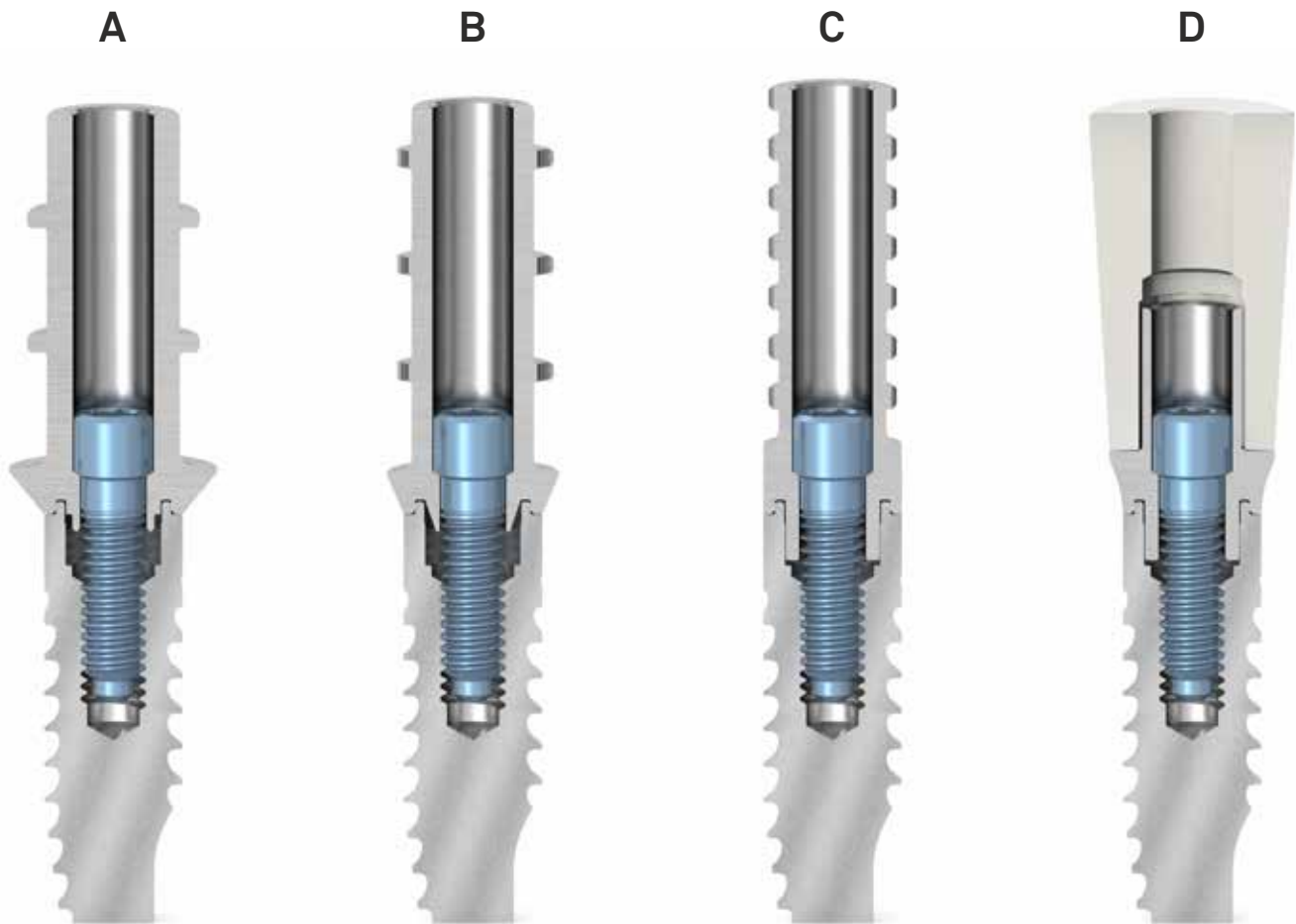

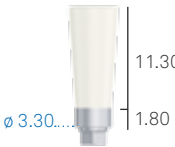
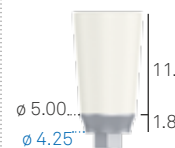
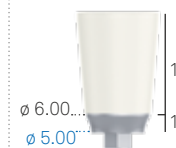

The Simple prosthetic protocol offers practical and simple solutions for the production of both single and multiple screw retained or cemented prosthetic structures. These prostheses can be used conventionally during the bone healing period, or immediately after the surgical insertion of implants, if the conditions for immediate loading are present. The titanium sleeves, given the different morphologies, can be adapted to suit any anatomy. The Simple posts in titanium with wide anatomical emergence simplify the immediate aesthetic conditioning of the mucosa in cases of multiple structures (**img. A**). Simple posts with straight emergence (**img. C**) and anatomical emergence (**img. B**) are available both with a centring cone for multiple structures to be tightened directly onto the implants even in presence of accentuated disparallelism or both with a repositioning hexagon for single crowns. The post in PEEK with a titanium base can be prepared chairside, making it possible to create cemented single crowns or multiple prostheses (**img. D**).



Simple posts in PEEK for Premium Kohno implants

prosthetic component \varnothing	3.30	3.80	4.25	5.00	6.00
for implants	Premium 3.30 - 3.80 Kohno 3.80	Premium 3.80 Kohno 3.80	Premium 4.25 Kohno 4.25	Premium 5.00 Kohno 5.00	Kohno 6.00
SIMPLE temporary posts in PEEK with a titanium base Engaging Straight emergence Fixation screw included	A-MPSC-330 	-	-	-	-
SIMPLE temporary posts in PEEK with a titanium base Engaging Anatomical emergence Fixation screw included	A-MPSCR-330 	A-MPSCR-380 	A-MPSCR-425 	A-MPSCR-500 	A-MPSCR-600 
Single pack Pack of 10 pieces	VM2-180 VM2-180-10	Use VM2-180	VM2-200 VM2-200-10	Use VM2-200	Use VM2-200
Fixation screw Supplied with the posts, it can also be ordered separately as a spare	 M 1.8		 M 2.0		

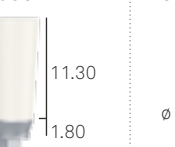

Simple posts in PEEK for Shelta implants

prosthetic component \varnothing	3.30	3.80	4.25	5.00
for implants	Shelta 3.80	Shelta 3.80 - 4.25 5.00 - 6.00	Shelta 4.25 - 5.00 - 6.00	Shelta 5.00 - 6.00
SIMPLE temporary posts in PEEK with a titanium base Engaging Straight emergence Fixation screw included	A-MPSC-330 	-	-	-
SIMPLE temporary posts in PEEK with a titanium base Engaging Anatomical emergence Fixation screw included	A-MPSCR-330 	A-MPSCR-380 	AS-MPSCR-425 	AS-MPSCR-500 
Single pack Pack of 10 pieces	VM2-180 VM2-180-10	Use VM2-180	Use VM2-180	Use VM2-180
Fixation screw Supplied with the posts, it can also be ordered separately as a spare	 M 1.8			

Recommended torque for temporary posts in PEEK: 20-25 Ncm.

See technical characteristics of Gr. 5 titanium and PEEK on pages 196 and 197.

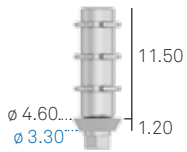
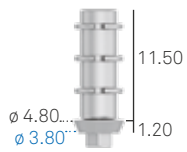
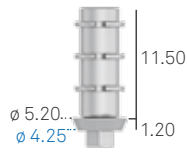
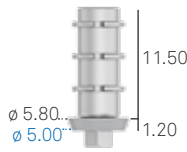
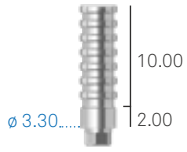
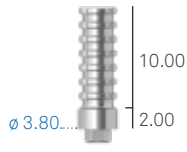
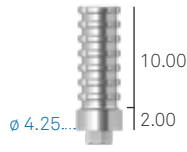
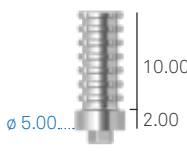
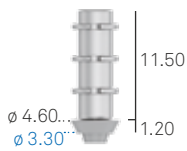
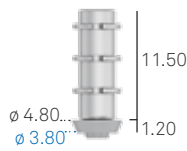
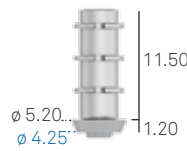
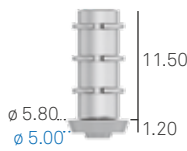
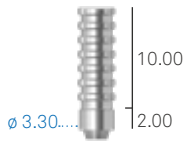
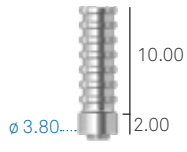
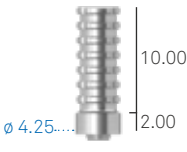
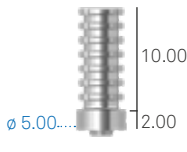
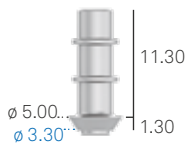
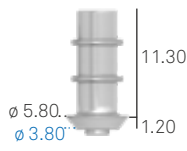
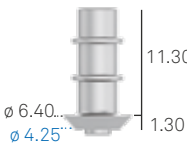
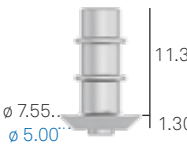
Simple posts in titanium for Premium Kohno implants





prosthetic component ø	3.30	3.80	4.25	5.00	6.00
for implants	Premium 3.30 - 3.80 Kohno 3.80	Premium 3.80 Kohno 3.80	Premium 4.25 Kohno 4.25	Premium 5.00 Kohno 5.00	Kohno 6.00
Simple temporary posts in titanium Engaging Anatomical emergence Fixation screw included	A-MPSA-330-EX 	A-MPSA-380-EX 	A-MPSA-425-EX 	A-MPSA-500-EX 	Use A-MPSA-500-EX
Simple temporary posts in titanium Engaging Straight emergence Fixation screw included	A-MPSCI-330-EX 	A-MPSCI-380-EX 	A-MPSCI-425-EX 	A-MPSCI-500-EX 	Use A-MPSCI-500-EX
Simple temporary posts in titanium Non engaging Anatomical emergence Fixation screw included	A-MPSA-330 	A-MPSA-380 	A-MPSA-425 	A-MPSA-500 	Use A-MPSA-500
Simple temporary posts in titanium Non engaging Straight emergence Fixation screw included	A-MPSCI-330 	A-MPSCI-380 	A-MPSCI-425 	A-MPSCI-500 	Use A-MPSCI-500
Simple temporary aesthetic posts in titanium Non engaging Anatomical emergence Fixation screw included	A-MPS-330 	A-MPS-380 	A-MPS-425 	A-MPS-500 	Use A-MPS-500
Single pack Pack of 10 pieces	VM2-180 VM2-180-10	Use VM2-180	VM2-200 VM2-200-10	Use VM2-200	Use VM2-200
Fixation screw Supplied with the posts, it can also be ordered separately as a spare	 M 1.8.....		 M 2.0.....		

Recommended torque for temporary posts in titanium: 20-25 Ncm.

Important warning

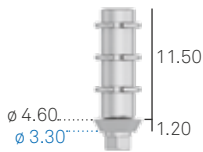
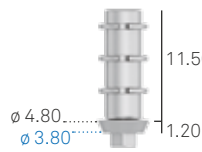
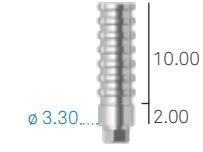
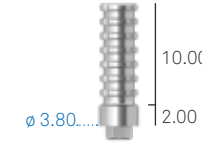
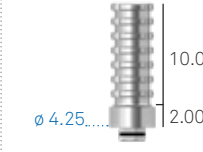
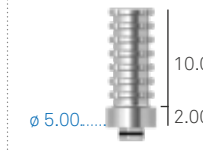
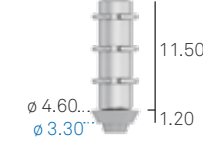
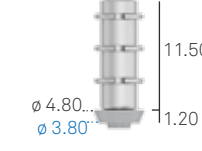
It is recommended always to use test screws for the laboratory phases and to keep the new screw supplied for the final fastening in the oral cavity.

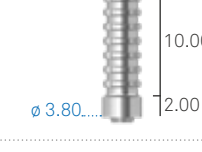
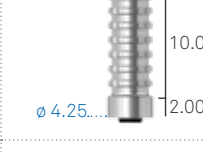
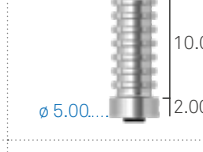
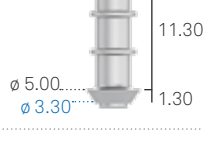
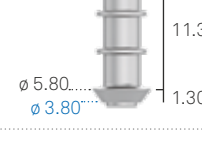
Simple posts in titanium for Shelta implants

prosthetic component \emptyset	3.30	3.80	4.25	5.00
for implants	Shelta 3.80	Shelta 3.80 - 4.25 5.00 - 6.00	Shelta 4.25 - 5.00 - 6.00	Shelta 5.00 - 6.00
Simple temporary posts in titanium Engaging Anatomical emergence Fixation screw included	A-MPSA-330-EX 	A-MPSA-380-EX 	-	-
Simple temporary posts in titanium Engaging Straight emergence Fixation screw included	A-MPSCI-330-EX 	A-MPSCI-380-EX 	AS-MPSCI-425-EX 	AS-MPSCI-500-EX 
Simple temporary posts in titanium Non engaging Anatomical emergence Fixation screw included	A-MPSA-330 	A-MPSA-380 	-	-
Simple temporary posts in titanium Non engaging Straight emergence Fixation screw included	A-MPSCI-330 	A-MPSCI-380 	AS-MPSCI-425 	AS-MPSCI-500 
Simple temporary aesthetic posts in titanium Non engaging Anatomical emergence Fixation screw included	A-MPS-330 	A-MPS-380 	-	-
Single pack Pack of 10 pieces Fixation screw Supplied with the posts, it can also be ordered separately as a spare	VM2-180 VM2-180-10 	Use VM2-180	Use VM2-180	Use VM2-180

Recommended torque for temporary posts in titanium: 20-25 Ncm.

Important warning

It is recommended always to use test screws for the laboratory phases and to keep the new screw supplied for the final fastening in the oral cavity.

Temporary single screw retained rehabilitation with Simple titanium sleeve

Remove the surgical cover screw or the healing abutment to expose the implant connection. Choose an engaging Simple temporary post in Gr. 5 titanium with the most suitable emergence profile and tighten it to the implant, leaving it initially at the original length. The recommended torque is 8-10 Ncm.



Insert a pre-made crown produced in the laboratory pierced so as to allow it to slide easily on the body of the post. Mark the palatal and vestibular margin of the temporary crown, so as to reduce the titanium sleeve appropriately.

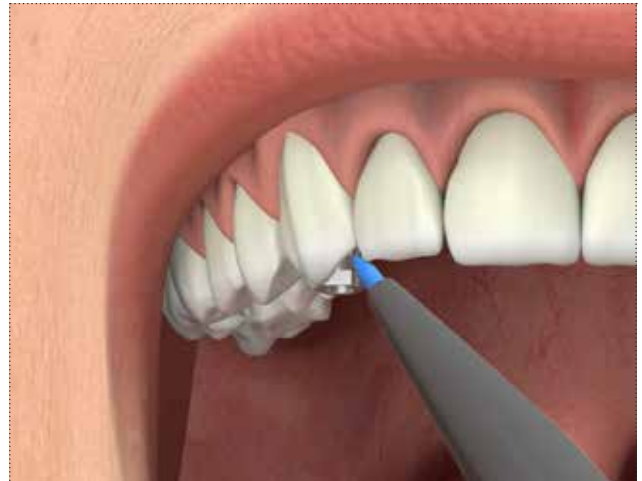

Remove the pre-made crown and unscrew the post. Screw it onto an analog and cut it at the marked height, using an abrasive disk.



Lute the temporary crown to the Simple temporary post, waiting for polymerization as indicated by the instructions.



When polymerization is complete, tighten the temporary post to the implant, taking care to keep the flaps of soft tissue away from the connection during inserting procedures. The temporary post must be tightened with the respective screw and a screwdriver from the HSM series. The recommended torque is 20–25 Ncm.



Insert teflon, gutta-percha or soft cement into the screw hole of the Simple temporary post and close the top with resin or a composite material to preserve the head of the screw. The temporary crown will help not only to ensure an adequate quality of life for the patient while waiting for the definitive prosthesis, but also the correct conformation of the soft tissues that will later receive the definitive prosthesis with excellent aesthetic results.

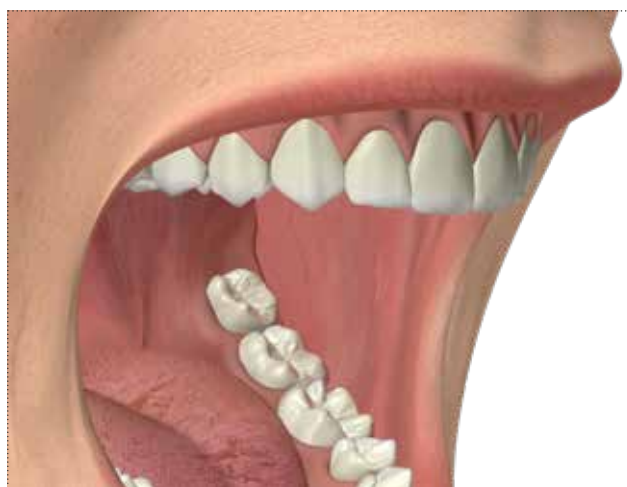

Temporary multiple screw retained rehabilitation with Simple titanium sleeves

Choose non engaging Simple temporary posts in Gr. 5 titanium with the most suitable emergence profile and tighten them to the analogs on the model, leaving them initially at the original length. The recommended torque is 8-10 Ncm.

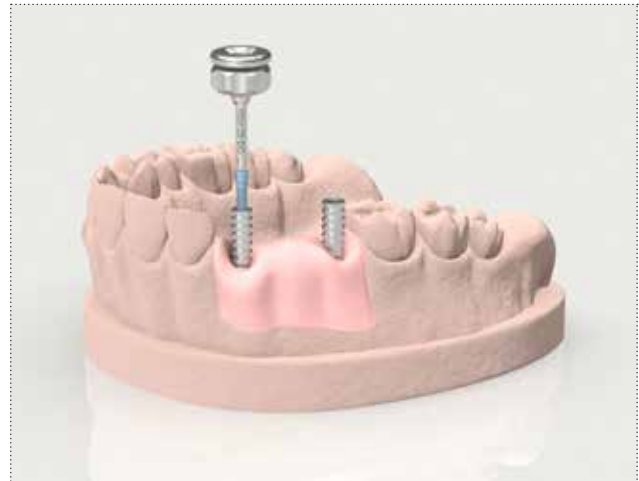

Insert a pre-made bridge produced in the laboratory pierced so as to allow it to slide easily on the body of the posts. Mark the palatal and vestibular margin of the temporary bridge, so as to reduce the titanium sleeves appropriately.



Remove the pre-made bridge and cut the posts on the model at the marked height, using an abrasive disk.



Lute the temporary bridge to the Simple temporary posts, waiting for polymerization as indicated by the instructions.



When polymerization is complete, unscrew the temporary bridge from the model and tighten it onto the implants, taking care to keep the flaps of soft tissues away from the connection during insertion procedures and suturing them around the emergence of the posts to permit adequate conditioning.

The temporary bridge must be tightened using the specific screws and a screwdriver from the HSM series. A tightening torque of 20-25 Ncm must not be exceeded.



Insert teflon, gutta-percha or soft cement into the screw hole of the Simple temporary posts and close the top with resin or a composite material to preserve the head of the screw. The temporary bridge will help not only to ensure an adequate quality of life for the patient while waiting for the definitive prosthesis, but also the correct conformation of the soft tissues that will later receive the definitive prosthesis with excellent aesthetic results.

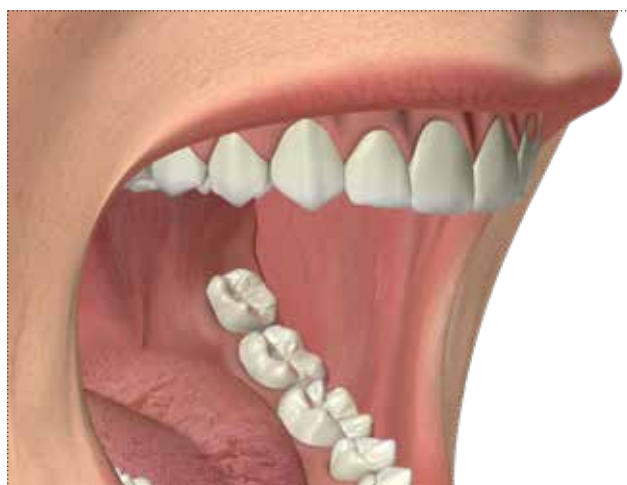

Temporary single cemented rehabilitation with Simple post in PEEK with a titanium base

Screw the Simple temporary post in PEEK of the chosen emergence into the patient's mouth or on the model using a screwdriver from the HSM series.

The tightening torque must not exceed 8–10 Ncm.

The palatal and the vestibular margin must be marked if tightened directly into the patient's mouth.

Important warning

It is always advisable to mill the post outside the oral cavity, screwing it on the model or even to an analog, to prevent vibrations from compromising the primary stability of the implant, especially in case of immediate loading.

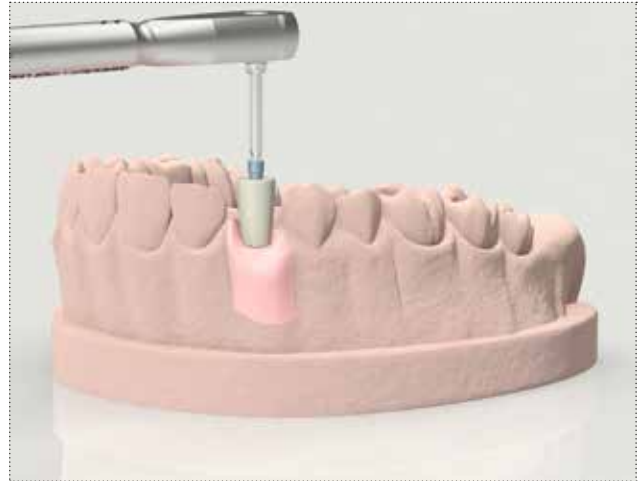

Reduce the height and diameter of the post, taking care to leave the screw head unaltered, to avoid the risk of modifying it and causing mechanical problems during screwing or unscrewing procedures.

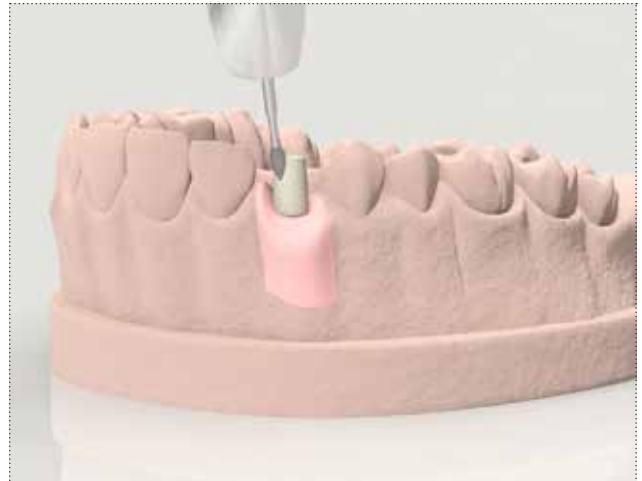

Create holes or retentive grooves on the PEEK body of the post to facilitate the cementation of the temporary crown.



Define the morphology, volume and occlusion, preparing a wax-up and creating the temporary crown using the preferred method.

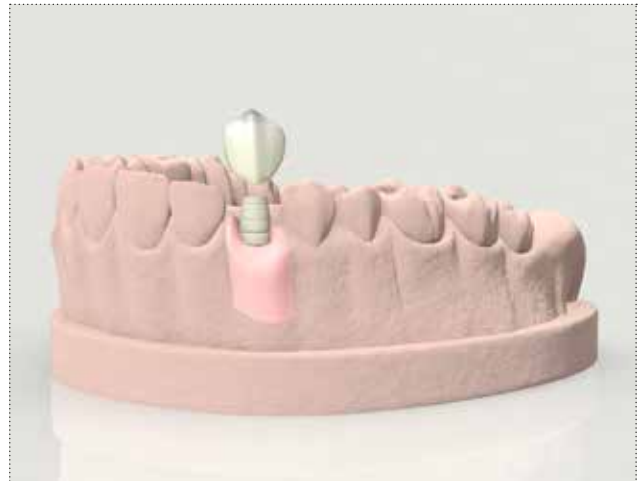

Screw the post in PEEK onto the implant using the appropriate screwdriver from the HSM series. The tightening recommended torque is 20–25 Ncm. Cover the screw hole and cement the crown on the post.

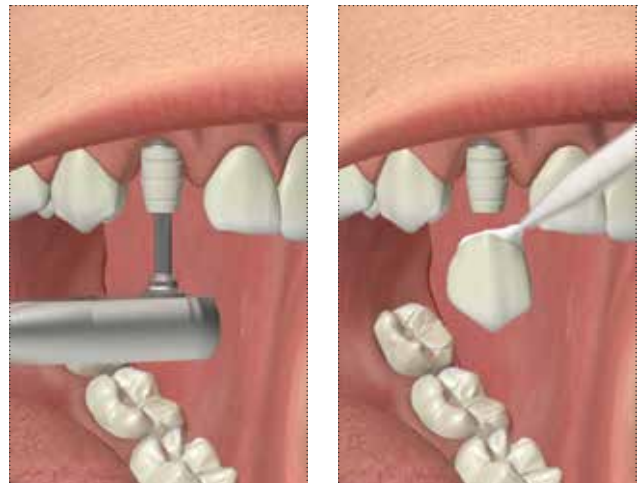

The temporary crown will help not only to ensure an adequate quality of life for the patient while waiting for the definitive prosthesis, but also the correct conformation of the soft tissues that will later receive the definitive prosthesis with excellent aesthetic results.

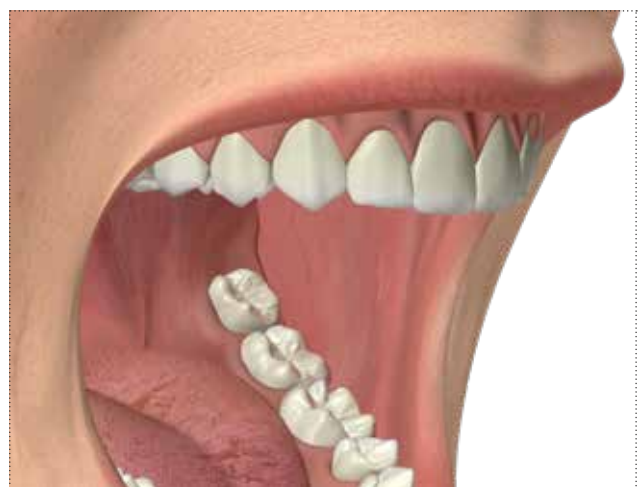

Temporary multiple cemented rehabilitation with Simple posts in PEEK with a titanium base

Screw the Simple temporary posts in PEEK of the chosen emergence into the patient's mouth or on the model using a screwdriver from the HSM series.

The tightening torque must not exceed 8–10 Ncm.

The palatal and the vestibular margin must be marked if tightened directly into the patient's mouth.

Important warning

It is always advisable to mill the post outside the oral cavity, screwing it on the model or even to an analog, to prevent vibrations from compromising the primary stability of the implant, especially in case of immediate loading.



Reduce the height and diameter of the posts, with the aid, if necessary, of a parallelometer, taking care to leave the screw heads unaltered to avoid the risk of modifying them and causing mechanical problems during screwing or unscrewing procedures.

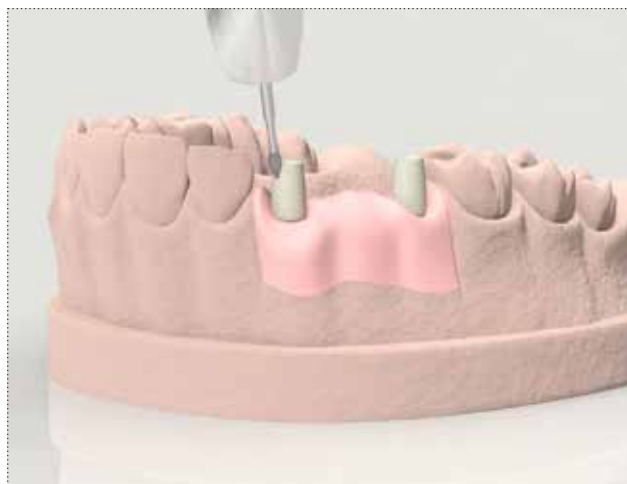

Create holes or retentive grooves on the PEEK body of the posts to facilitate the cementation of the temporary bridge.



Define the morphology, volume and occlusion, preparing a wax-up and creating the temporary bridge using the preferred method.



Screw the posts in PEEK onto the implants using the appropriate screwdriver from the HSM series. The tightening recommended torque is 20–25 Ncm. Cover the screw holes and cement the bridge on the posts.

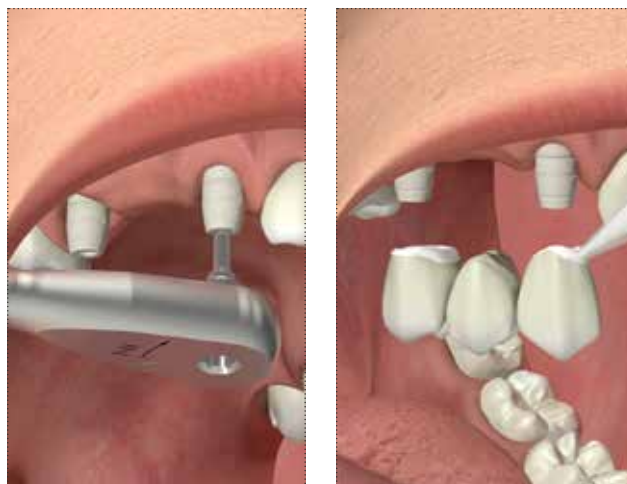

The temporary bridge will help not only to ensure an adequate quality of life for the patient while waiting for the definitive prosthesis, but also the correct conformation of the soft tissues that will later receive the definitive prosthesis with excellent aesthetic results.





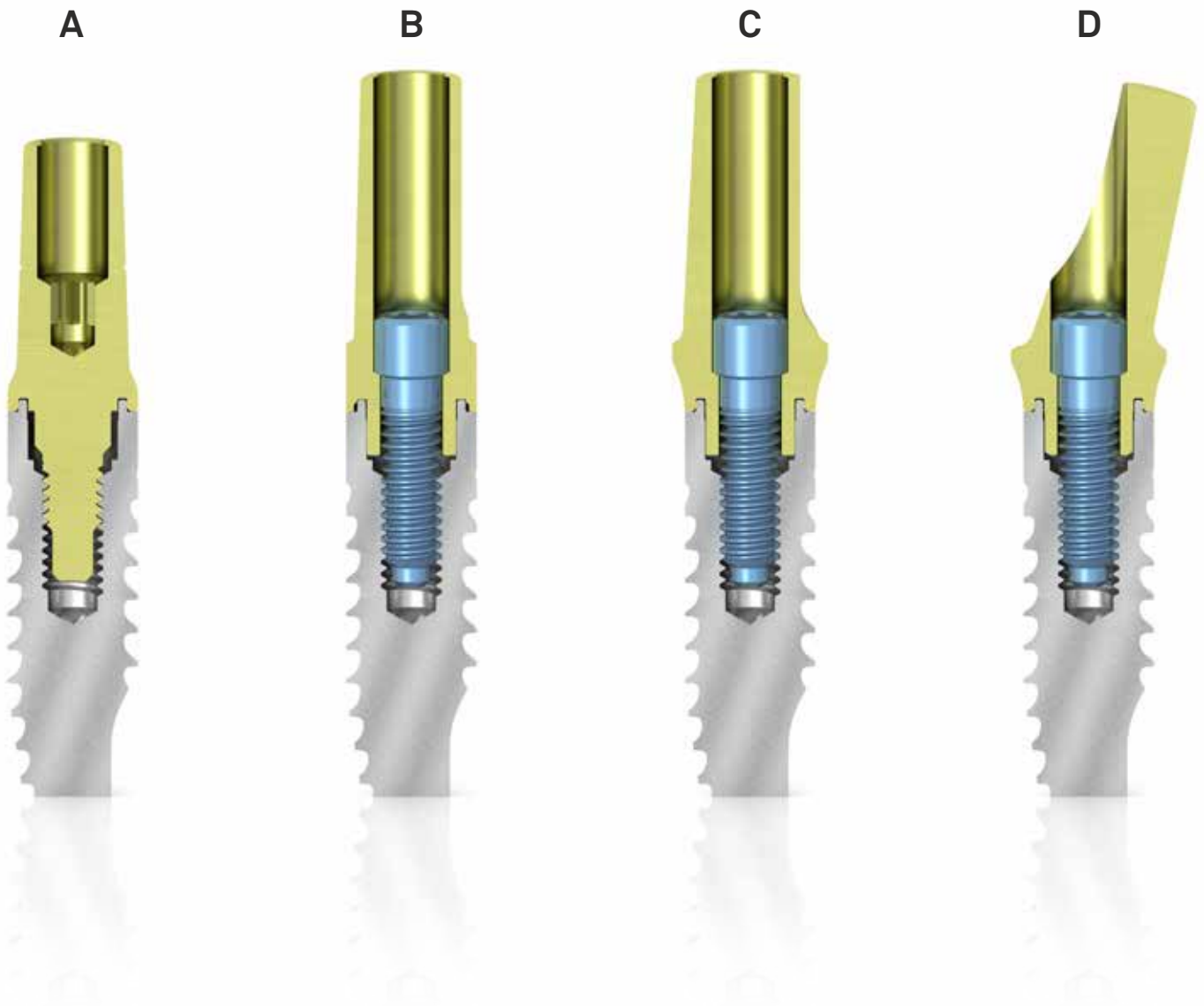

Definitive rehabilitation with pre-made posts

Pre-made posts are made of Gr. 5 titanium and are subjected to a process of controlled passivation that changes their colour to a characteristic golden pale yellow. This colour is the result of an oxidation process, therefore without any kind of coating, thereby guaranteeing the use of a highly biocompatible surface.

The straight pre-made posts are available in two versions: one for direct screwing, without the need of a screw (**img. A**), meant for the production of multiple cemented structures, and another with the hexagon, for single rehabilitations; the straight pre-made posts are available both with straight emergence (**img. B**), ideal in cases of limited adjacent spaces, and with anatomical emergence (**img. C**). The angled posts with repositioning hexagon are available with angles of 15° and 25° (**img. D**).

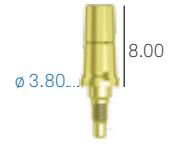
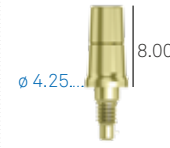
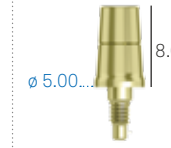
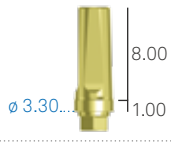
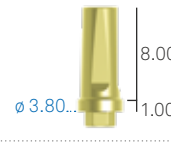

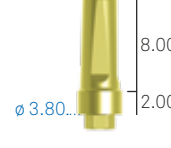
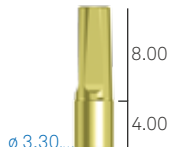
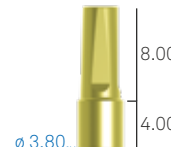
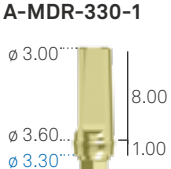
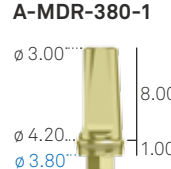
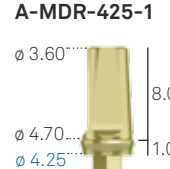
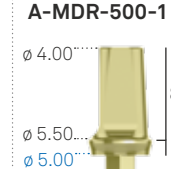
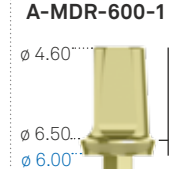
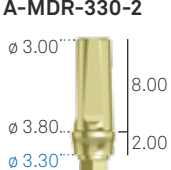
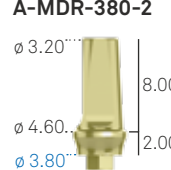
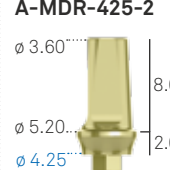
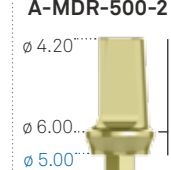
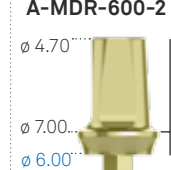
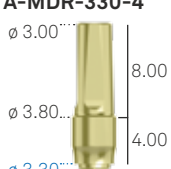
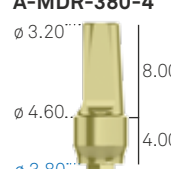
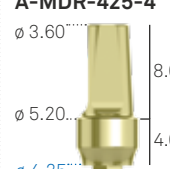
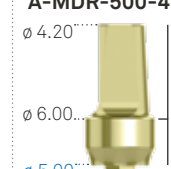
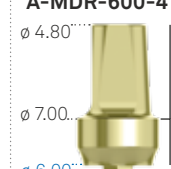







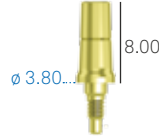
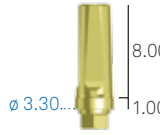
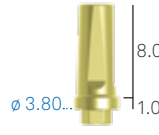
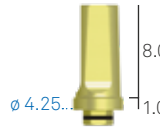
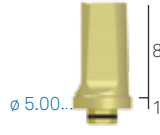
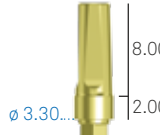
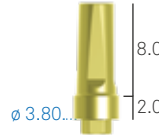
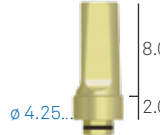

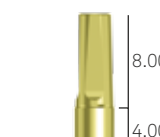
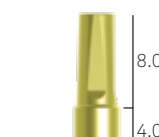
Pre-made straight posts for Premium Kohno implants

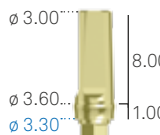
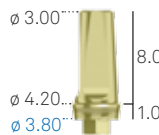
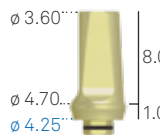
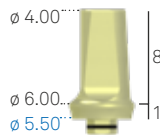
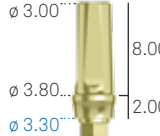
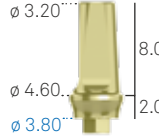
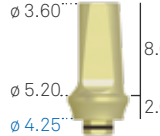
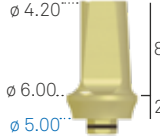
prosthetic component \varnothing	3.30	3.80	4.25	5.00	6.00
for implants	Premium 3.30 - 3.80 Kohno 3.80	Premium 3.80 Kohno 3.80	Premium 4.25 Kohno 4.25	Premium 5.00 Kohno 5.00	Kohno 6.00
Pre-made posts for direct screwing* Non engaging	A-MDAD-330  \varnothing 3.30... 8.00	A-MDAD-380  \varnothing 3.80... 8.00	A-MDAD-425  \varnothing 4.25... 8.00	A-MDAD-500  \varnothing 5.00... 8.00	Use A-MDAD-500
Pre-made posts Engaging Straight emergence Transgingival H. 1 mm Fixation screw included	A-MD-330-1  \varnothing 3.30... 8.00 1.00	A-MD-380-1  \varnothing 3.80... 8.00 1.00	-	-	-
Pre-made posts Engaging Straight emergence Transgingival H. 2 mm Fixation screw included	A-MD-330-2  \varnothing 3.30... 8.00 2.00	A-MD-380-2  \varnothing 3.80... 8.00 2.00	-	-	-
Pre-made posts Engaging Straight emergence Transgingival H. 4 mm Fixation screw included	A-MD-330-4  \varnothing 3.30... 8.00 4.00	A-MD-380-4  \varnothing 3.80... 8.00 4.00	-	-	-
Pre-made posts Engaging Anatomical emergence Transgingival H. 1 mm Fixation screw included	A-MDR-330-1  \varnothing 3.00... 8.00 \varnothing 3.60... 1.00 \varnothing 3.30...	A-MDR-380-1  \varnothing 3.00... 8.00 \varnothing 4.20... 1.00 \varnothing 3.80...	A-MDR-425-1  \varnothing 3.60... 8.00 \varnothing 4.70... 1.00 \varnothing 4.25...	A-MDR-500-1  \varnothing 4.00... 8.00 \varnothing 5.50... 1.00 \varnothing 5.00...	A-MDR-600-1  \varnothing 4.60... 8.00 \varnothing 6.50... 1.00 \varnothing 6.00...
Pre-made posts Engaging Anatomical emergence Transgingival H. 2 mm Fixation screw included	A-MDR-330-2  \varnothing 3.00... 8.00 \varnothing 3.80... 2.00 \varnothing 3.30...	A-MDR-380-2  \varnothing 3.20... 8.00 \varnothing 4.60... 2.00 \varnothing 3.80...	A-MDR-425-2  \varnothing 3.60... 8.00 \varnothing 5.20... 2.00 \varnothing 4.25...	A-MDR-500-2  \varnothing 4.20... 8.00 \varnothing 6.00... 2.00 \varnothing 5.00...	A-MDR-600-2  \varnothing 4.70... 8.00 \varnothing 7.00... 2.00 \varnothing 6.00...
Pre-made posts Engaging Anatomical emergence Transgingival H. 4 mm Fixation screw included	A-MDR-330-4  \varnothing 3.00... 8.00 \varnothing 3.80... 4.00 \varnothing 3.30...	A-MDR-380-4  \varnothing 3.20... 8.00 \varnothing 4.60... 4.00 \varnothing 3.80...	A-MDR-425-4  \varnothing 3.60... 8.00 \varnothing 5.20... 4.00 \varnothing 4.25...	A-MDR-500-4  \varnothing 4.20... 8.00 \varnothing 6.00... 4.00 \varnothing 5.00...	A-MDR-600-4  \varnothing 4.80... 8.00 \varnothing 7.00... 4.00 \varnothing 6.00...
Single pack Pack of 10 pieces	VM2-180 VM2-180-10	Use VM2-180	VM2-200 VM2-200-10	Use VM2-200	Use VM2-200
Fixation screw Supplied with the posts, it can also be ordered separately as a spare	 M 1.8.....		 M 2.0.....		

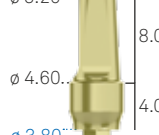



* The pre-made posts for direct screwing do not require the fixation screw. Recommended torque for pre-made posts for direct screwing: 25-30 Ncm. Recommended torque for pre-made posts with passing screw: 20-25 Ncm. See technical characteristics of Gr. 5 titanium on page 196.

Pre-made straight posts for Shelta implants

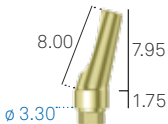

prosthetic component \varnothing	3.30	3.80	4.25	5.00
for implants	Shelta 3.80	Shelta 3.80 - 4.25 5.00 - 6.00	Shelta 4.25 - 5.00 - 6.00	Shelta 5.00 - 6.00
Pre-made posts for direct screwing* Non engaging	A-MDAD-330  \varnothing 3.30... 8.00	A-MDAD-380  \varnothing 3.80... 8.00	-	-
Pre-made posts Engaging Straight emergence Transgingival H. 1 mm Fixation screw included	A-MD-330-1  \varnothing 3.30... 8.00 1.00	A-MD-380-1  \varnothing 3.80... 8.00 1.00	AS-MD-425-1  \varnothing 4.25... 8.00 1.00	AS-MD-500-1  \varnothing 5.00... 8.00 1.00
Pre-made posts Engaging Straight emergence Transgingival H. 2 mm Fixation screw included	A-MD-330-2  \varnothing 3.30... 8.00 2.00	A-MD-380-2  \varnothing 3.80... 8.00 2.00	AS-MD-425-2  \varnothing 4.25... 8.00 2.00	AS-MD-500-2  \varnothing 5.00... 8.00 2.00
Pre-made posts Engaging Straight emergence Transgingival H. 4 mm Fixation screw included	A-MD-330-4  \varnothing 3.30... 8.00 4.00	A-MD-380-4  \varnothing 3.80... 8.00 4.00	AS-MD-425-4  \varnothing 4.25... 8.00 4.00	AS-MD-500-4  \varnothing 5.00... 8.00 4.00
Pre-made posts Engaging Anatomical emergence Transgingival H. 1 mm Fixation screw included	A-MDR-330-1  \varnothing 3.00... 8.00 \varnothing 3.60... 1.00 \varnothing 3.30...	A-MDR-380-1  \varnothing 3.00... 8.00 \varnothing 4.20... 1.00 \varnothing 3.80...	AS-MDR-425-1  \varnothing 3.60... 8.00 \varnothing 4.70... 1.00 \varnothing 4.25...	AS-MDR-500-1  \varnothing 4.00... 8.00 \varnothing 6.00... 1.00 \varnothing 5.50...
Pre-made posts Engaging Anatomical emergence Transgingival H. 2 mm Fixation screw included	A-MDR-330-2  \varnothing 3.00... 8.00 \varnothing 3.80... 2.00 \varnothing 3.30...	A-MDR-380-2  \varnothing 3.20... 8.00 \varnothing 4.60... 2.00 \varnothing 3.80...	AS-MDR-425-2  \varnothing 3.60... 8.00 \varnothing 5.20... 2.00 \varnothing 4.25...	AS-MDR-500-2  \varnothing 4.20... 8.00 \varnothing 6.00... 2.00 \varnothing 5.00...
Pre-made posts Engaging Anatomical emergence Transgingival H. 4 mm Fixation screw included	A-MDR-330-4  \varnothing 3.00... 8.00 \varnothing 3.80... 4.00 \varnothing 3.30...	A-MDR-380-4  \varnothing 3.20... 8.00 \varnothing 4.60... 4.00 \varnothing 3.80...	AS-MDR-425-4  \varnothing 3.60... 8.00 \varnothing 5.20... 4.00 \varnothing 4.25...	AS-MDR-500-4  \varnothing 4.20... 8.00 \varnothing 6.00... 4.00 \varnothing 5.00...
Single pack Pack of 10 pieces	VM2-180 VM2-180-10	Use VM2-180	Use VM2-180	Use VM2-180
Fixation screw Supplied with the posts, it can also be ordered separately as a spare	 M 1.8.....			

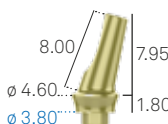
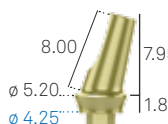
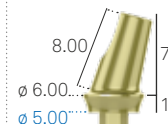
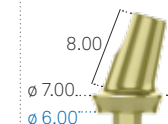
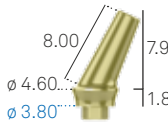
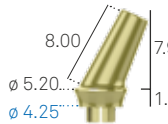
* The pre-made posts for direct screwing do not require the fixation screw. Recommended torque for pre-made posts for direct screwing: 25-30 Ncm. Recommended torque for pre-made posts with passing screw: 20-25 Ncm.

Pre-made angled posts for Premium Kohno implants

prosthetic component \varnothing	3.30	3.80	4.25	5.00	6.00
for implants	Premium 3.30 - 3.80 Kohno 3.80	Premium 3.80 Kohno 3.80	Premium 4.25 Kohno 4.25	Premium 5.00 Kohno 5.00	Kohno 6.00
Pre-made posts Angled at 15° Engaging Straight emergence Transgingival H. 1.75 mm Fixation screw included	A-MA15-330 	-	-	-	-
Pre-made posts Angled at 15° Engaging Anatomical emergence Transgingival H. 1.80 mm Fixation screw included	A-MAR15-330 	A-MAR15-380 	A-MAR15-425 	A-MAR15-500 	A-MAR15-600 
Pre-made posts Angled at 25° Engaging Anatomical emergence Transgingival H. 1.80 mm Fixation screw included	-	A-MAR25-380 	A-MAR25-425 	-	-
Single pack Pack of 10 pieces	VM2-180 VM2-180-10	Use VM2-180	VM2-200 VM2-200-10	Use VM2-200	Use VM2-200
Fixation screw Supplied with the posts, it can also be ordered separately as a spare	 M 1.8		 M 2.0		

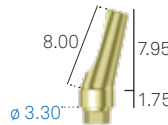
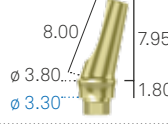
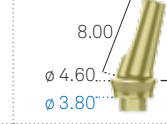
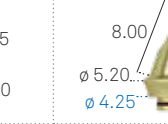
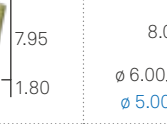
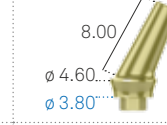
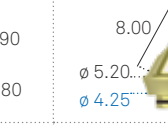
Pre-made angled posts for Shelta implants

prosthetic component \varnothing	3.30	3.80	4.25	5.00
for implants	Shelta 3.80	Shelta 3.80 - 4.25 5.00 - 6.00	Shelta 4.25 - 5.00 6.00	Shelta 5.00 - 6.00
Pre-made posts angled at 15° Engaging Straight emergence Transgingival H. 1.75 mm Fixation screw included	A-MA15-330 	-	-	-
Pre-made posts angled at 15° Engaging Anatomical emergence Transgingival H. 1.80 mm Fixation screw included	A-MAR15-330 	A-MAR15-380 	AS-MAR15-425 	AS-MAR15-500 
Pre-made posts angled at 25° Engaging Anatomical emergence Transgingival H. 1.80 mm Fixation screw included	-	A-MAR25-380 	AS-MAR25-425 	-
Single pack Pack of 10 pieces	VM2-180 VM2-180-10	Use VM2-180	Use VM2-180	Use VM2-180
Fixation screw Supplied with the posts, it can also be ordered separately as a spare	 M 1.8			

Recommended torque for pre-made angled posts: 20-25 Ncm.
See technical characteristics of Gr. 5 titanium on page 196.

Definitive single cemented rehabilitation with pre-made post

Insert a pre-made engaging post on the precision model, choosing the most suitable transgingival height and any necessary angle at 15° or 25°.
Tighten the post with the specific screw at a maximum torque of 8-10 Ncm.

Important warning

It is recommended always to use test screws for the laboratory phases and to keep the new screw supplied for the final fastening in the oral cavity.

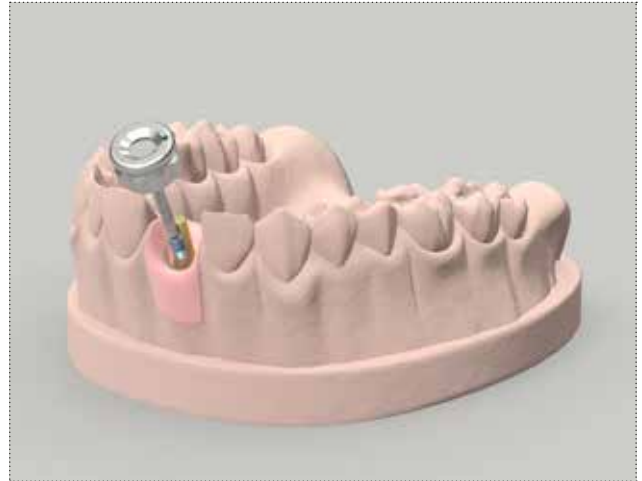

Reduce the height of the post if necessary, and correct its inclination with a suitable drill, without altering the screw head.

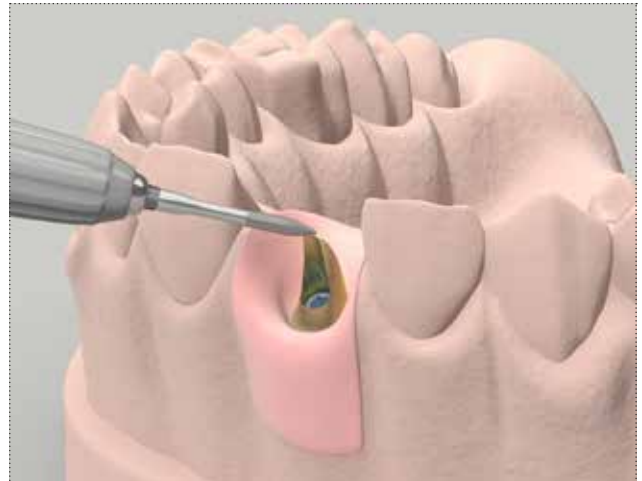

Model the cap on the post in wax or resin, leaving sufficient space for the cement.

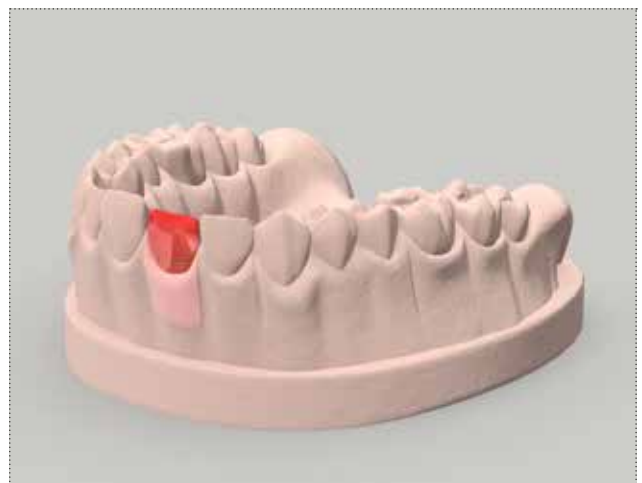

Fabricate the cap by casting or using CAD CAM technologies. Test the crown on the model to check that there is no roughness that could obstruct the correct positioning of the cap on the post, and correct it if necessary with a drill.

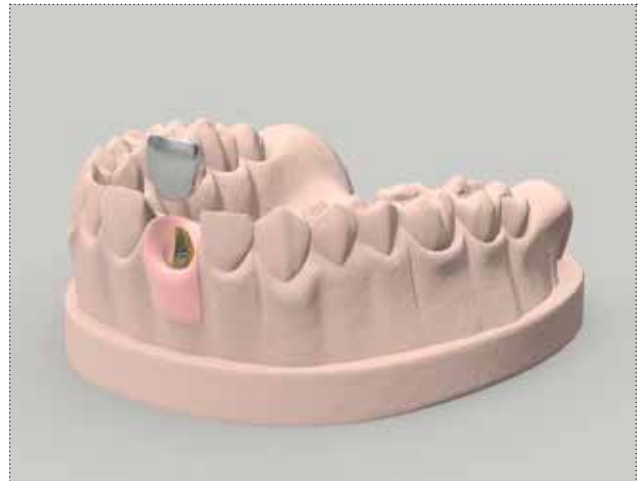

Position the post in the patient's mouth and tighten it with the supplied screw, applying a torque of 20–25 Ncm.



Cover the screw hole, ceramize the final prosthesis as usual and cement the crown on the post, taking care to remove all the excess cement from the margin.



Definitive multiple cemented rehabilitation with pre-made posts

Insert pre-made posts for direct screwing or pre-made engaging posts on the precision model, choosing the most suitable transgingival height and any necessary angle at 15° or 25°.
Tighten the posts with the specific screw at a maximum torque of 8-10 Ncm.

Important warning

It is recommended always to use test screws for the laboratory phases and to keep the new screw supplied for the final fastening in the oral cavity.

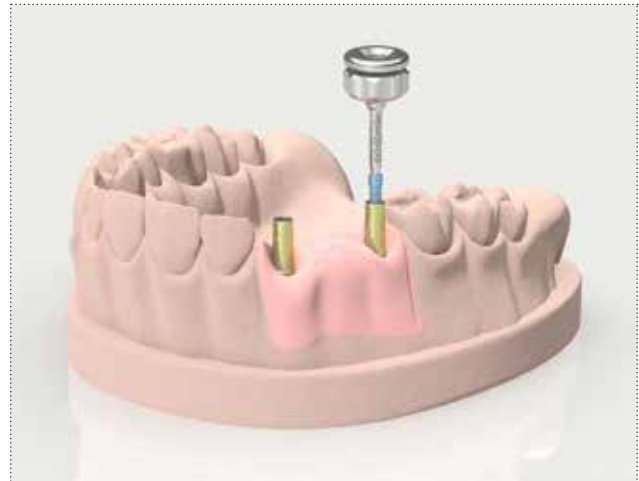

Reduce the height of the posts if necessary, and correct their inclination with a suitable drill, without altering the screw head.

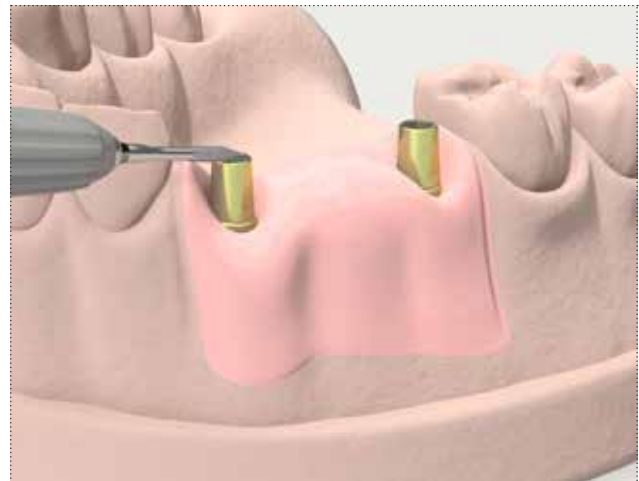

Model the structure on the posts in wax or resin, leaving sufficient space for the cement.



Fabricate the bridge by casting or using CAD CAM technologies. Test the structure on the model to check that there is no roughness that could obstruct the correct positioning of the bridge on the posts, and correct it if necessary with a drill.



Position the posts in the patient's mouth and tighten them with the supplied screw, applying a torque of 20–25 Ncm in case of engaging posts, and of 25–30 Ncm in case of posts for direct screwing.



Cover the screw holes, ceramize the final prosthesis as usual and cement the bridge on the posts, taking care to remove all the excess cement from the margin.



Try-in kit

The kit is composed of a complete series of Try-in in anodized aluminium, available in different angles, profiles and transgingival emergence heights, useful for the laboratory to check the spaces occupied by the pre-made posts in the model design phase, especially in case of immediate loading. The practical plexiglass box is divided in compartments, in which every single piece is placed. Under the seat of each single Try-in there are two codes: at the top, the code of the respective post to be ordered for the final prosthesis, at bottom right the code of the Try-in, for re-ordering if required. The kit is meant for the odontotechnic laboratory, it is not a medical device and it is not meant for sterilization.

The colour code identifies the diameter of the connection platform

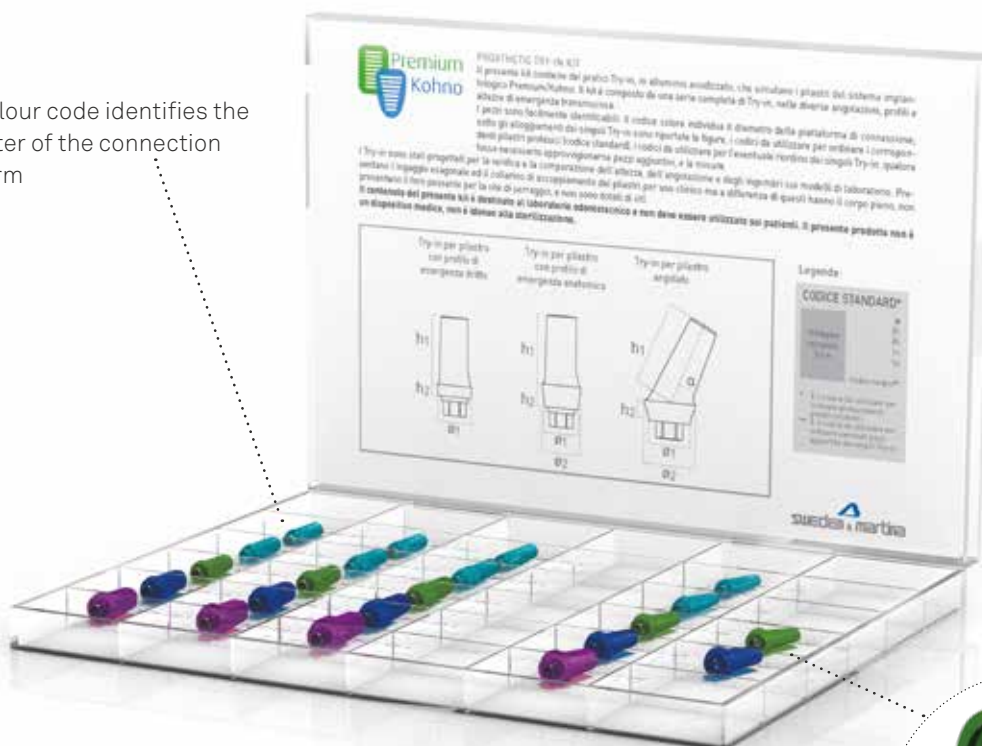

The Try-ins are without fixation screws because the hexagonal connections have practical retentive tabs. The friction also allows the Try-in to be used in an articulator on the model of the upper arch



description	code
Complete Try-in Kit for Premium and Kohno implants (Straight, SP)	A- TRY-IN-KIT
Empty tray in Plexiglass	A- T-TRAY



Conditions of use in the laboratory

Below it is illustrated how to use the Try-in in the laboratory after the casting of the model. The Try-in are engaged onto the analogs of the respective diameter, easy to be identified thanks to the anodization of the aluminium with the colour code of the reference platform. There is no need of screws and screwdrivers for the insertion of the Try-in, thanks to the retentive tabs at the base which allow an easy removal. The Try-in cannot be used in the patient's mouth.

It is possible to study the occlusal relationships on the model and in the articulator in order to choose the most suitable type of profile, transgingival height and angle to the clinical case. Once chosen the pre-made posts of the most suitable size, the final posts can be ordered.

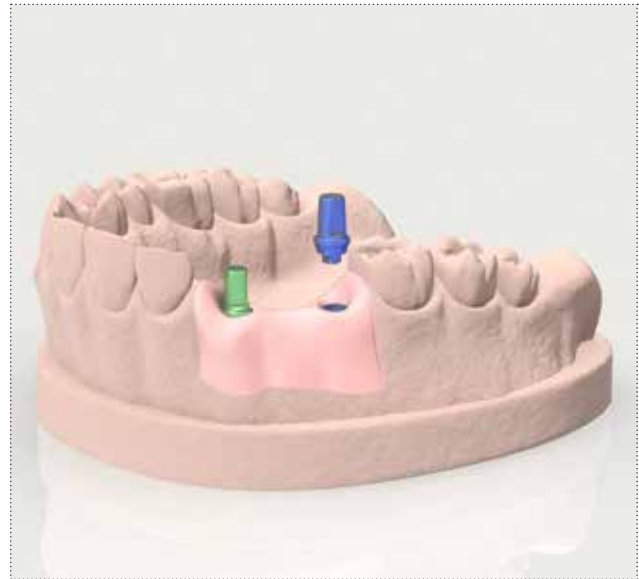

The images show the tests on the model in the case of a front tooth to choose the most appropriate angulation between the ones available, 15° and 25°.

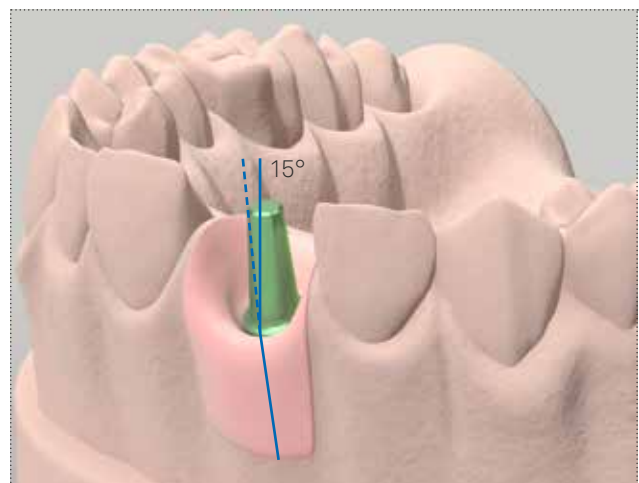
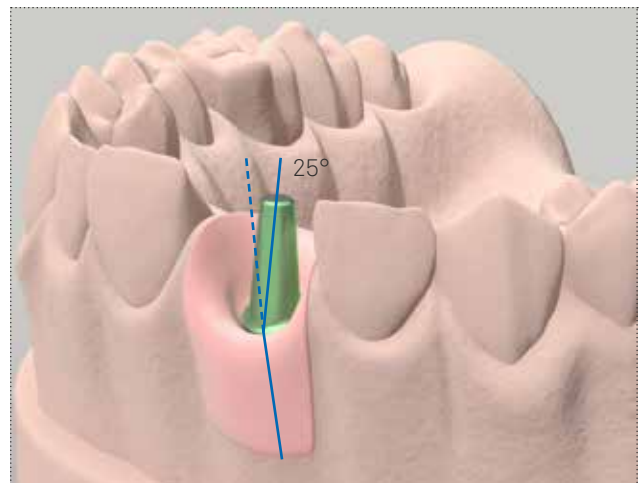

Definitive rehabilitation with preparable posts

The preparable posts are made of Gr. 5 titanium and are available in four different morphologies:

- Straight preparable posts (**img. A**);
- Pre-cut preparable posts (**img. B**);
- Simple preparable posts (**img. C**);
- Preparable post for Interceptive Technique (**img. D**).

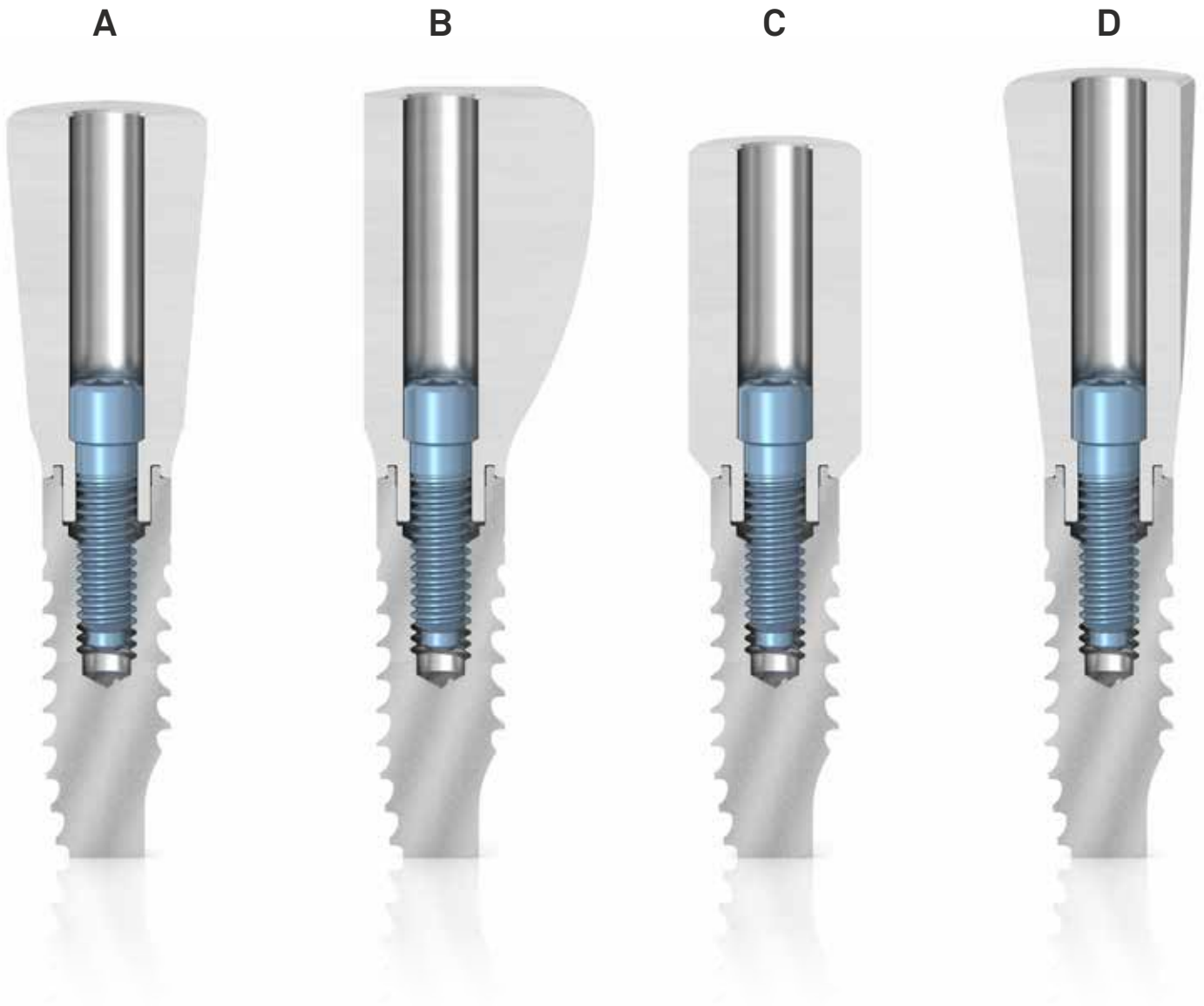

Preparable posts allow for fabrication of cemented protocols both on single crowns and multiple structures, and have been designed in order to satisfy complex anatomical needs in terms both of prosthetic spaces and disparallel implants, thanks to the possibility of being prepared.

A characteristic profile in the shape of an inverted cone makes these posts ideal for angles of up to 10° and small profiles











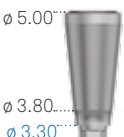

Simple posts can be adapted to any anatomy obtained with Simple temporary posts

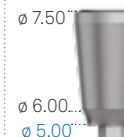
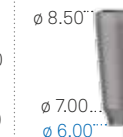

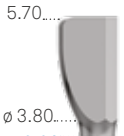
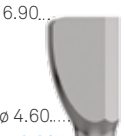
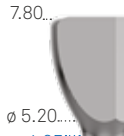
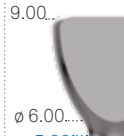
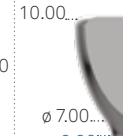
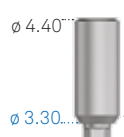
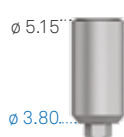
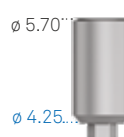
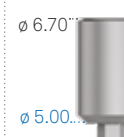
The geometry of pre-cut preparable posts permits very pronounced angles to be reached, up to 25°, limiting the time of preparation







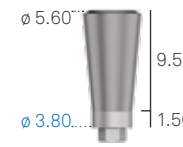
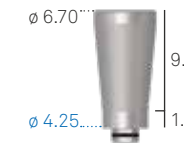

The emergence profile of the posts for Interceptiv Technique simplifies the taking of the impression with closed tray technique and the two wide faces guarantee the repositioning in the impression material

Preparable posts for Premium Kohno implants

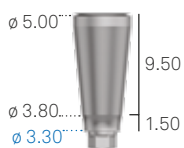
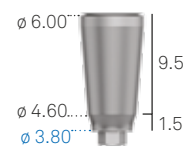
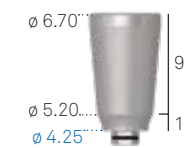
prosthetic component ø	3.30	3.80	4.25	5.00	6.00
for implants	Premium 3.30 - 3.80 Kohno 3.80	Premium 3.80 Kohno 3.80	Premium 4.25 Kohno 4.25	Premium 5.00 Kohno 5.00	Kohno 6.00
Straight preparable posts Engaging Straight emergence Fixation screw included	A-MF-330 	A-MF-380 	A-MF-425 	-	-
Straight preparable posts Engaging Anatomical emergence Fixation screw included	A-MFR-330 	A-MFR-380 	A-MFR-425 	A-MFR-500 	A-MFR-600 
Pre-cut preparable posts Engaging Straight emergence Fixation screw included	A-MFP-330 	-	-	-	-
Pre-cut preparable posts Engaging Anatomical emergence Fixation screw included	A-MFPR-330 	A-MFPR-380 	A-MFPR-425 	A-MFPR-500 	A-MFPR-600 
Simple preparable posts Engaging Very wide emergence Fixation screw included	A-MFS-330 	A-MFS-380 	A-MFS-425 	A-MFS-500 	-
Preparable posts for Interceptive Technique Engaging Fixation screw included	-	A-MFTI-380 	A-MFTI-425 	A-MFTI-500 	Use A-MFTI-500
Single pack Pack of 10 pieces	VM2-180 VM2-180-10	Use VM2-180	VM2-200 VM2-200-10	Use VM2-200	Use VM2-200
Fixation screw Supplied with the posts, it can also be ordered separately as a spare	M 1.8 		M 2.0 		

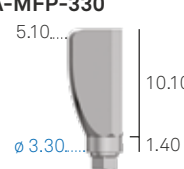
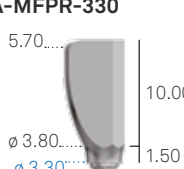
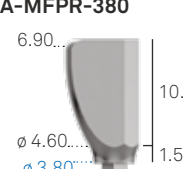
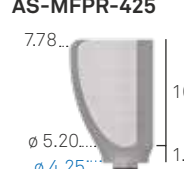
Recommended torque for preparable posts: 20-25 Ncm.

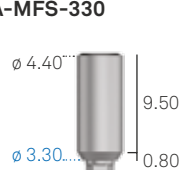
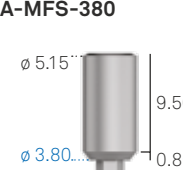
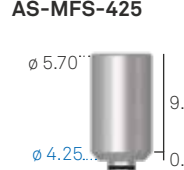
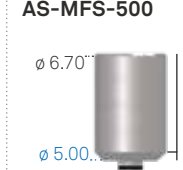
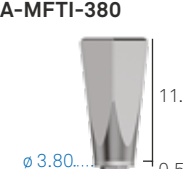
Preparable posts for Shelta implants

prosthetic component \varnothing	3.30	3.80	4.25	5.00
for implants	Shelta 3.80	Shelta 3.80 - 4.25 5.00 - 6.00	Shelta 4.25 - 5.00 - 6.00	Shelta 5.00 - 6.00
Straight preparable posts Engaging Straight emergence Fixation screw included	A-MF-330 	A-MF-380 	AS-MF-425 	AS-MF-500 
Straight preparable posts Engaging Anatomical emergence Fixation screw included	A-MFR-330 	A-MFR-380 	AS-MFR-425 	AS-MFR-500 
Pre-cut preparable posts Engaging Straight emergence Fixation screw included	A-MFP-330 	-	-	-
Pre-cut preparable posts Engaging Anatomical emergence Fixation screw included	A-MFPR-330 	A-MFPR-380 	AS-MFPR-425 	AS-MFPR-500 
Simple preparable posts Engaging Very wide emergence Fixation screw included	A-MFS-330 	A-MFS-380 	AS-MFS-425 	AS-MFS-500 
Preparable posts for Interceptive Technique Engaging Fixation screw included	-	A-MFTI-380 	-	-
Single pack Pack of 10 pieces Fixation screw Supplied with the posts, it can also be ordered separately as a spare	VM2-180 VM2-180-10 	Use VM2-180	Use VM2-180	Use VM2-180

Recommended torque for preparable posts: 20-25 Ncm.

Definitive single cemented rehabilitation with preparable posts

Insert a preparable post on the precision model of the most suitable morphology among the ones available on page 84. The image reports a pre-cut preparable post, which helps to compensate for the natural angle of the maxillary bone. Tighten the post with the specific screw, applying a maximum torque of 8-10 Ncm.

Important warning

It is recommended always to use test screws for the laboratory phases and to keep the new screw supplied for the final fastening in the oral cavity.

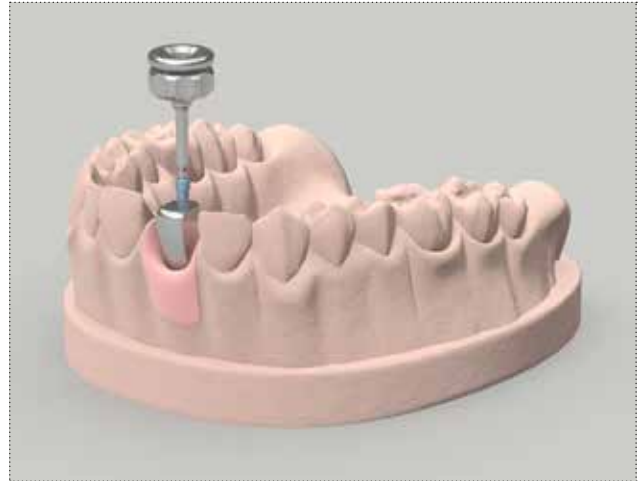

Model the post by reducing it in height and volume, as necessary.

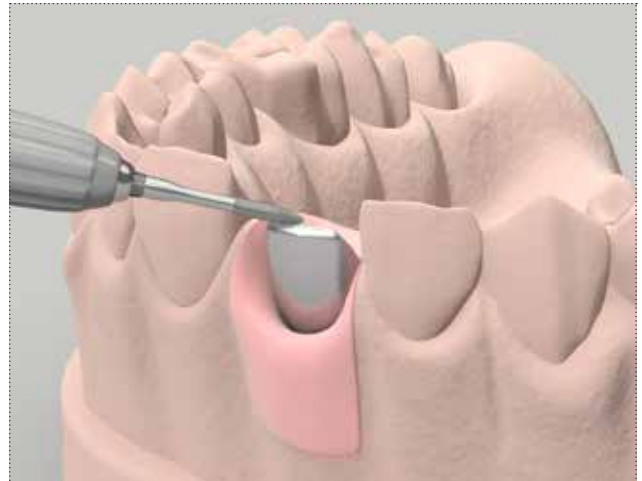

Model the cap on the post in wax or resin, leaving sufficient space for the cement.

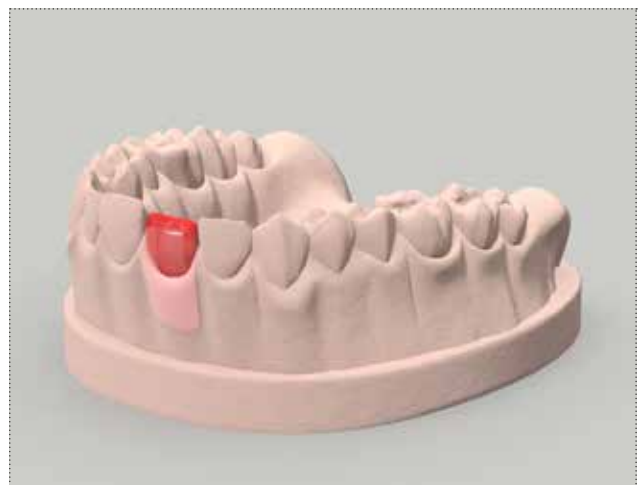

Fabricate the cap by casting or using CAD CAM technologies. Test the crown on the model to check that there is no roughness that could obstruct the correct positioning of the cap on the post, and correct it if necessary with a drill.

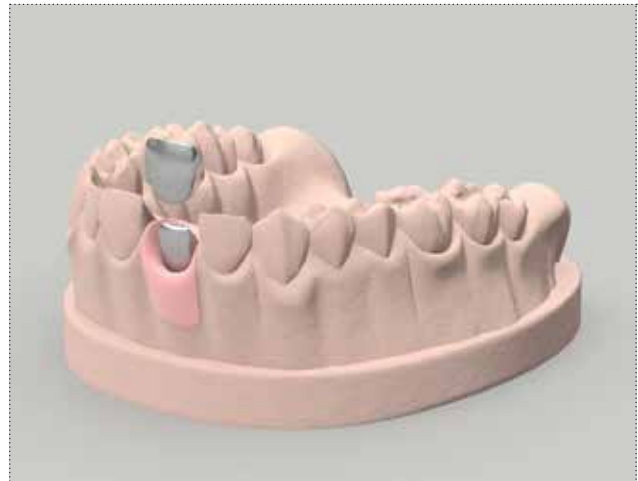

Position the post in the patient's mouth and tighten it with the supplied screw, applying a torque of 20–25 Ncm.



Cover the screw hole, ceramize the final prosthesis as usual and cement the crown on the post, taking care to remove all the excess cement from the margin.



Definitive multiple cemented rehabilitation with preparable posts

Insert the preparable posts on the precision model of the chosen morphology among the ones available on page 84. The image shows the use of straight posts with anatomical emergence. Tighten the post with the specific screw, applying a maximum torque of 8-10 Ncm.

Important warning

It is recommended always to use test screws for the laboratory phases and to keep the new screw supplied for the final fastening in the oral cavity.

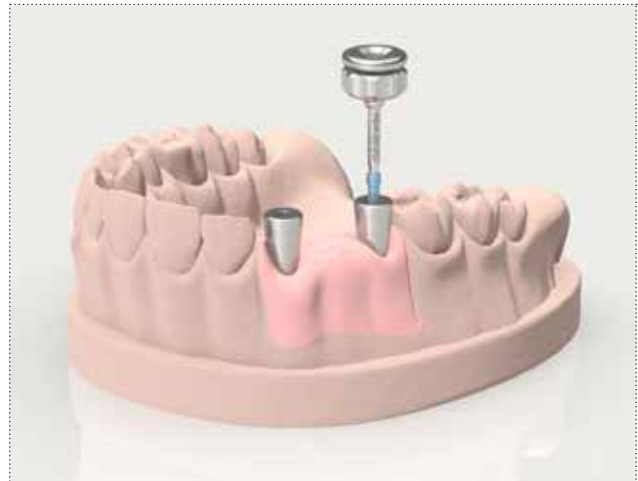

Model the posts, reducing them in height and volume, and correct, if necessary, eventual disparallelisms with a parallelometer.

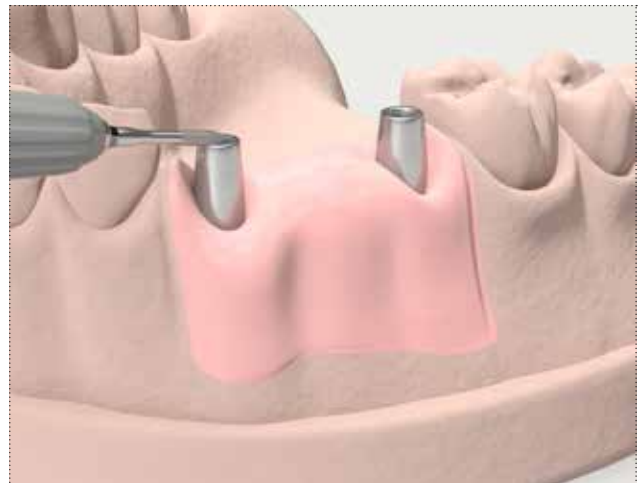

Model the structure on the posts in wax or resin, leaving sufficient space for the cement.



Fabricate the bridge by casting or using CAD CAM technologies. Test the structure on the model to check that there is no roughness that could obstruct the correct positioning of the bridge on the posts, and correct it if necessary with a drill.



Position the posts in the patient's mouth and tighten them with the supplied screw, applying a torque of 20–25 Ncm.



Cover the screw holes, ceramize the final prosthesis as usual and cement the bridge on the posts, taking care to remove all the excess cement from the margin.



Definitive multiple cemented rehabilitation with preparable posts for Interceptive Technique

Expose the implant connections if a protocol with a double surgical phase has been adopted, or remove the healing abutments.



Tighten the preparable posts for Interceptive Technique (cod. A-MFTI-*) with the supplied screw and the most suitable driver of the HSM series, without exceeding the torque of 20-25 Ncm.

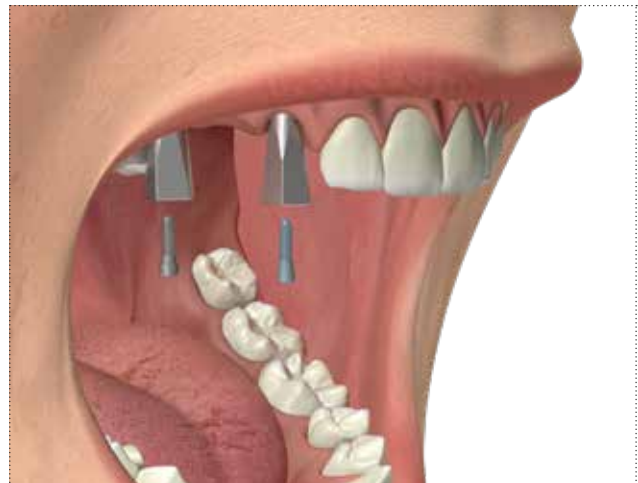

Choose a tray of suitable dimensions, so that the height of the posts is contained inside the walls of the impression tray.

Inject a precision impression material (i.e. SKY IMPLANT LIGHT, code SKY14) around the posts and at the same time fill the impression tray with a more consistent material (i.e. SKY IMPLANT ONEMIX-ED, code SKY08) over the entire arch.



Then position the tray *in situ* and wait for the hardening times as indicated by the instructions.

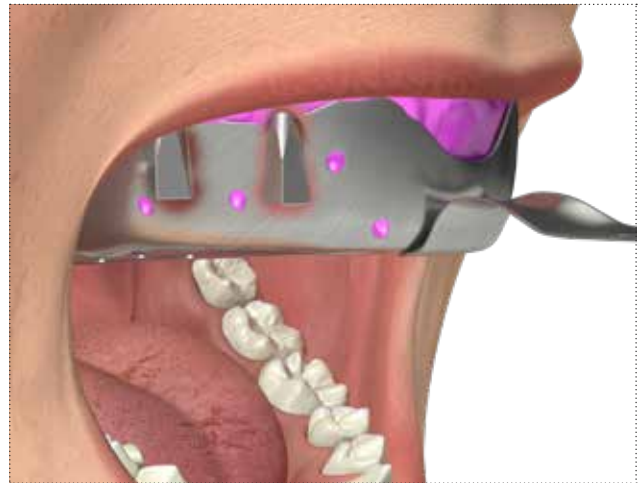

Remove the tray: the posts for Interceptive Technique remain tightened to the implants. Unscrew the posts with a screwdriver of the HSM series.

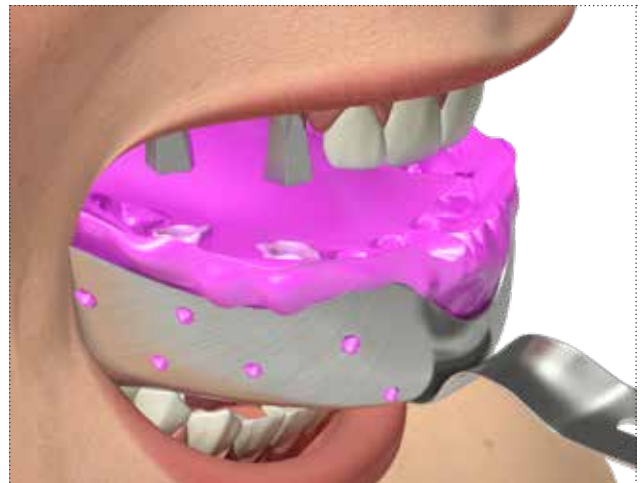

Screw the laboratory analogs to the posts using the supplied screw and reposition them in the holes left in the impression material.
The recommended torque is 8-10 Ncm.
Develop the model as usual.



Once the impression is taken, the posts for Interceptiv Technique, which have been working as transfers, will already be in the correct position.



Model the posts by reducing them in height and volume, and correct any disparallelisms as necessary, with the assistance of a parallelometer.

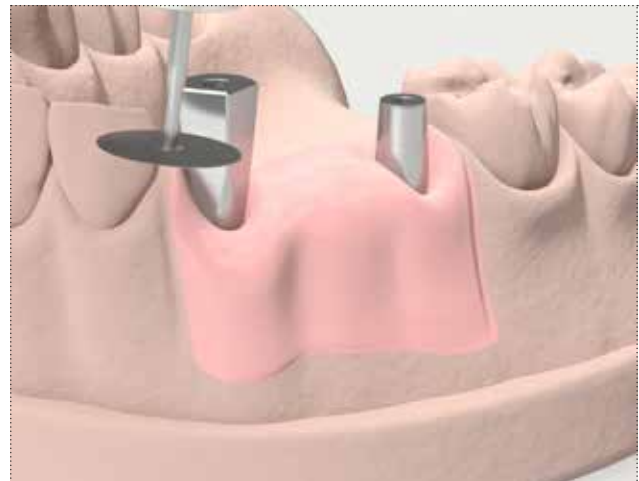

Model the structure in wax or resin, leaving sufficient space for the cement, and cast as usual.



Fabricate the bridge by casting or using CAD CAM technologies. Test the structure on the model to check that there is no roughness that could obstruct the correct positioning of the bridge on the posts, and correct it if necessary with a drill.



Position the posts in the patient's mouth and tighten them with the supplied screw, applying a torque of 20–25 Ncm.



Cover the screw holes, ceramize the final prosthesis as usual and cement the bridge on the posts, taking care to remove all the excess cement from the margin.



Definitive rehabilitation with castable posts with a metal base

Sweden & Martina produces posts of various types with a castable portion and a metal base for overcasting, suitable for the production of prosthetic solutions for single crowns, screw retained Toronto bridges and conventional Implant bridges, depending on the vertical height to be recovered:

- Castable posts in PMMA with base in gold alloy;
- Castable posts in PMMA with base in titanium;
- Castable posts in PMMA with base in cobalt-chrome.

The castable posts in PMMA with a metal base permit to produce single crowns or bridges by overcasting (see advices for overcasting base alloys on page 202).

The recommended torque for the final fastening of the posts after the casting and the overcasting is 20-25 Ncm.

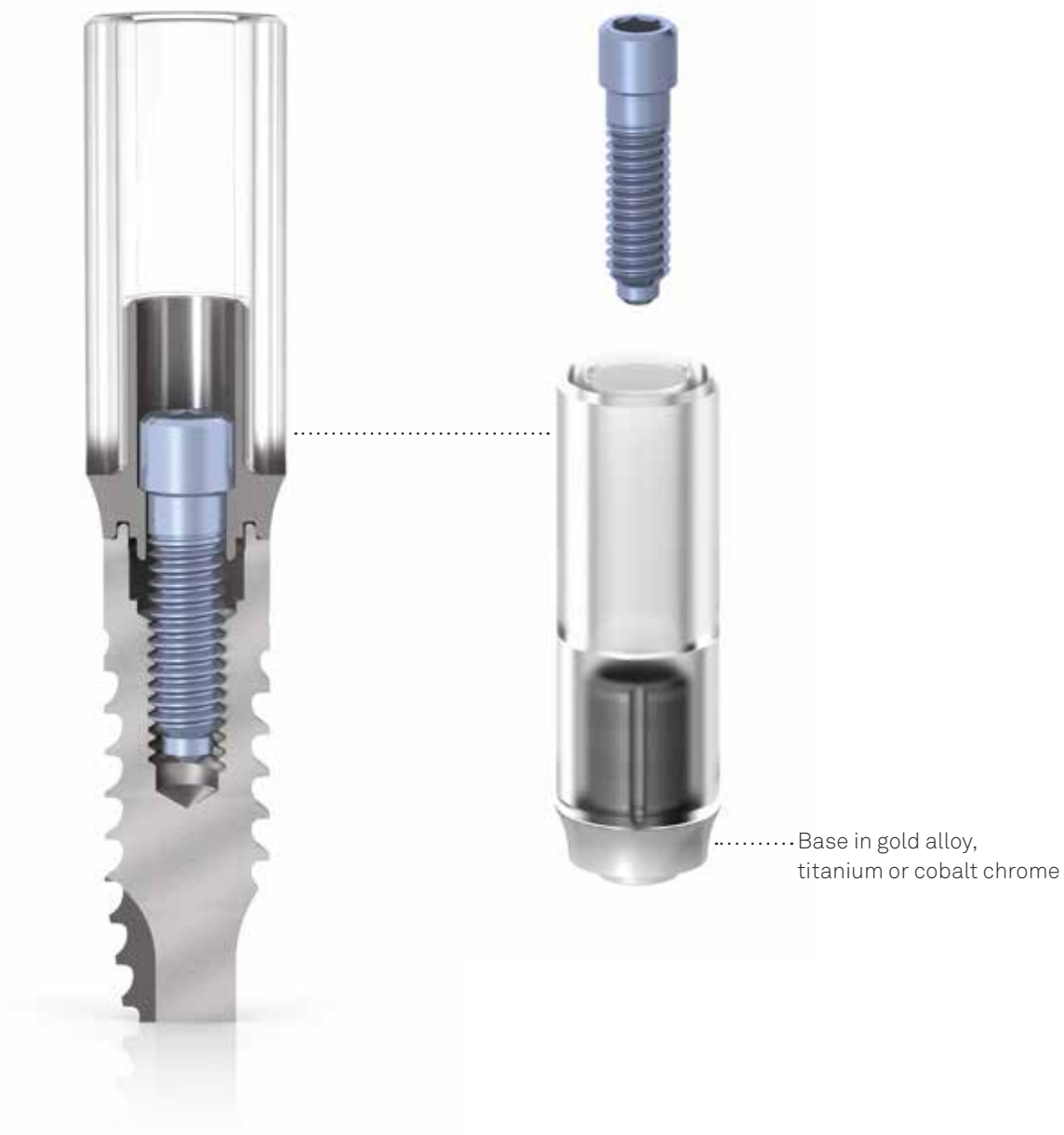

Definitive rehabilitation with entirely castable posts*





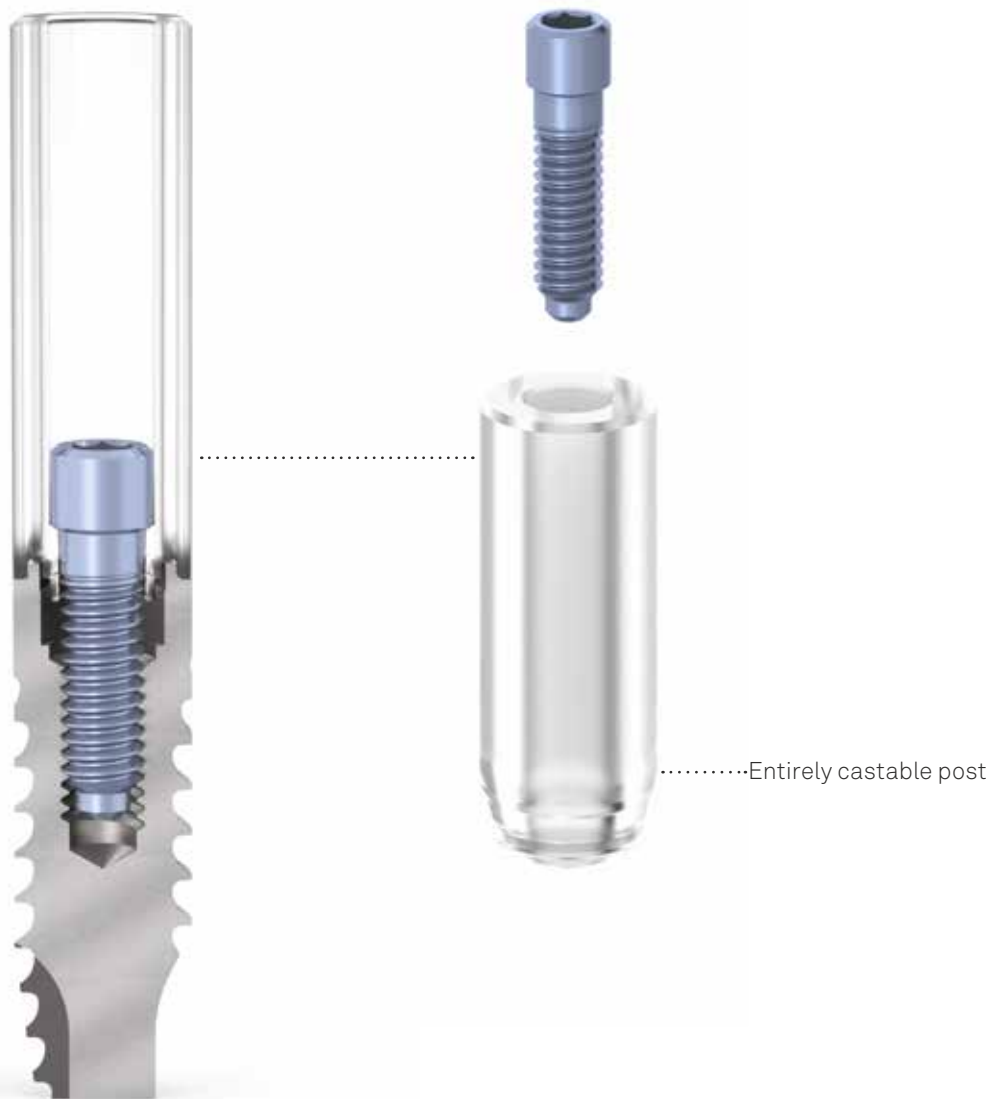

The entirely castable posts are made through turning of PMMA, a material that does not leave any residue during the casting phase.

Note: the casting of entirely castable posts, for its own limits, hardly maintains the same micrometric tolerances obtainable by milling of castable posts with a metal base

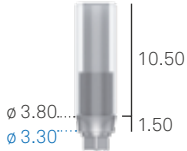
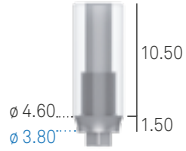
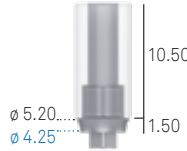
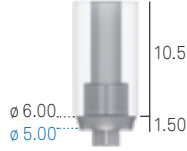
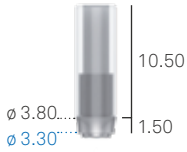
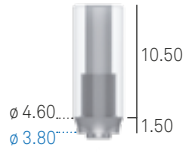
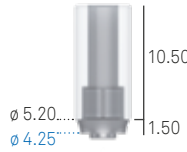
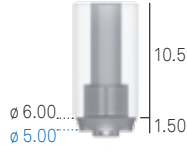
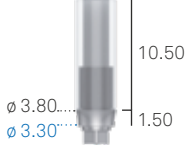
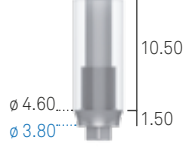
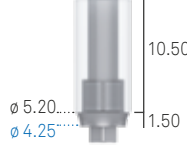
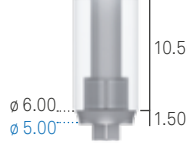
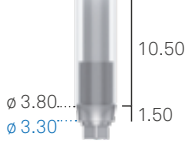
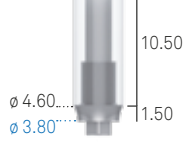
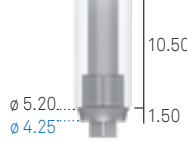
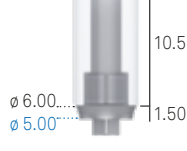
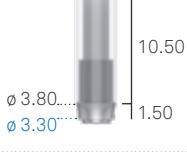
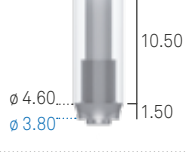
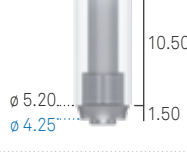
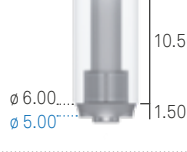

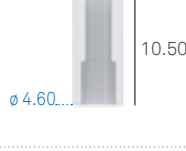

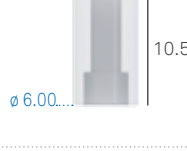



*Entirely castable posts may not be released for sale in all markets.

Castable posts with a metal base for Premium Kohno implants

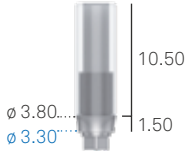
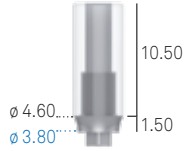
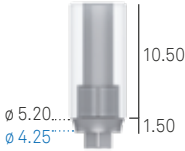
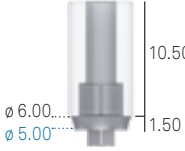
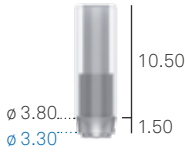
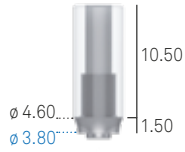
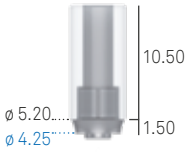
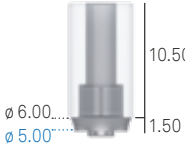
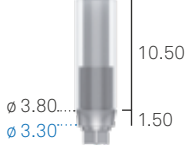
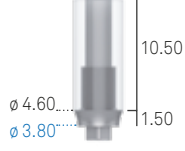
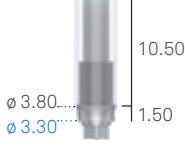
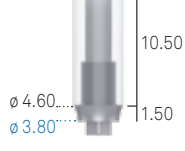
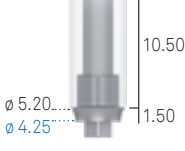
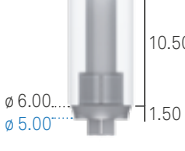
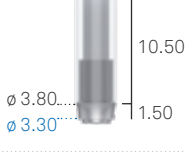
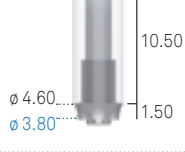
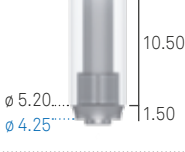
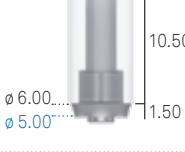
prosthetic component \varnothing	3.30	3.80	4.25	5.00
for implants	Premium 3.30 - 3.80 Kohno 3.80	Premium 3.80 Kohno 3.80	Premium 4.25 Kohno 4.25	Premium 5.00 Kohno 5.00 - 6.00
Castable posts with a pre-made base in gold alloy "1" Engaging Anatomical emergence Fixation screw included	A-UCR-330-EX 	A-UCR-380-EX 	A-UCR-425-EX 	A-UCR-500-EX 
Castable posts with a pre-made base in gold alloy "1" Non engaging Anatomical emergence Fixation screw included	A-UCR-330 	A-UCR-380 	A-UCR-425 	A-UCR-500 
Castable posts with a pre-made base in titanium Engaging Anatomical emergence Fixation screw included	A-UCTR-330-EX 	A-UCTR-380-EX 	A-UCTR-425-EX 	A-UCTR-500-EX 
Castable posts with a pre-made base in cobalt-chrome Engaging Anatomical emergence Fixation screw included	A-UCRCO-330-EX 	A-UCRCO-380-EX 	A-UCRCO-425-EX 	A-UCRCO-500-EX 
Castable posts with a pre-made base in cobalt-chrome Non engaging Anatomical emergence Fixation screw included	A-UCRCO-330 	A-UCRCO-380 	A-UCRCO-425 	A-UCRCO-500 
Spare castable sleeves for castable posts with a metal base Without fixation screw	A-CCUCR-330 	A-CCUCR-380 	A-CCUCR-425 	A-CCUCR-500 
Single pack Pack of 10 pieces	VM2-180 VM2-180-10	Use VM2-180	VM2-200 VM2-200-10	Use VM2-200
Fixation screw Supplied with the posts and also available separately as a spare	M 1.8..... 		M 2.0..... 	

Recommended torque for castable posts with a metal base: 20-25 Ncm.







Castable posts with a metal base for Shelta implants

prosthetic component \varnothing	3.30	3.80	4.25	5.00
for implants	Shelta 3.80	Shelta 3.80 - 4.25 5.00 - 6.00	Shelta 4.25 - 5.00 - 6.00	Shelta 5.00 - 6.00
Castable posts with a pre-made base in gold alloy "1" Engaging Anatomical emergence Fixation screw included	A-UCR-330-EX 	A-UCR-380-EX 	AS-UCR-425-EX 	AS-UCR-500-EX 
Castable posts with a pre-made base in gold alloy "1" Non engaging Anatomical emergence Fixation screw included	A-UCR-330 	A-UCR-380 	AS-UCR-425 	AS-UCR-500 
Castable posts with a pre-made base in titanium Engaging Anatomical emergence Fixation screw included	A-UCTR-330-EX 	A-UCTR-380-EX 	-	-
Castable posts with a pre-made base in cobalt-chrome Engaging Anatomical emergence Fixation screw included	A-UCRCO-330-EX 	A-UCRCO-380-EX 	AS-UCRCO-425-EX 	AS-UCRCO-500-EX 
Castable posts with a pre-made base in cobalt-chrome Non engaging Anatomical emergence Fixation screw included	A-UCRCO-330 	A-UCRCO-380 	AS-UCRCO-425 	AS-UCRCO-500 
Spare castable sleeves for castable posts with a metal base Without fixation screw	A-CCUCR-330 	A-CCUCR-380 	AS-CCUCR-425 	AS-CCUCR-500 
Single pack Pack of 10 pieces Fixation screw Supplied with the posts and also available separately as a spare	VM2-180 VM2-180-10 	Use VM2-180	Use VM2-180	Use VM2-180

Recommended torque for castable posts with a metal base: 20-25 Ncm.

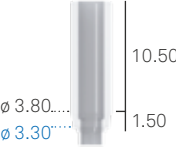
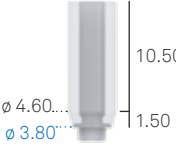
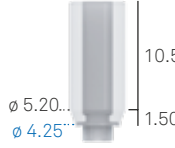
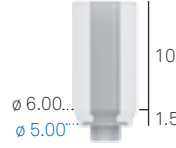
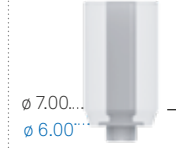
See technical characteristics of Gr. 5 titanium, gold alloy, cobalt-chrome and PMMA on pages 196, 200, 201 e 198.

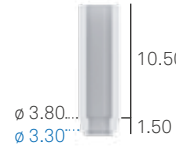
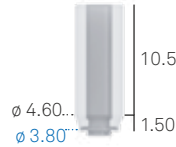
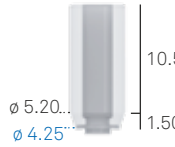
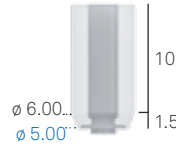
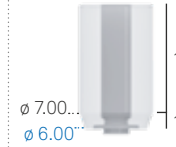
Entirely castable posts for Premium Kohno implants

prosthetic component ϕ	3.30	3.80	4.25	5.00	6.00
for implants	Premium 3.30 - 3.80 Kohno 3.80	Premium 3.80 Kohno 3.80	Premium 4.25 Kohno 4.25	Premium 5.00 Kohno 5.00	Kohno 6.00
Castable posts in PMMA for casting Engaging Straight emergence Fixation screw included	A-CC-330-EX 	A-CC-380-EX 	-	-	-
Castable posts in PMMA for casting Engaging Anatomical emergence Fixation screw included	A-CCR-330-EX 	A-CCR-380-EX 	A-CCR-425-EX 	A-CCR-500-EX 	A-CCR-600-EX 
Castable posts in PMMA for casting Non engaging Straight emergence Fixation screw included	A-CC-330 	A-CC-380 	-	-	-
Castable posts in PMMA for casting Non engaging Anatomical emergence Fixation screw included	A-CCR-330 	A-CCR-380 	A-CCR-425 	A-CCR-500 	A-CCR-600 
Single pack Pack of 10 pieces	VM2-180 VM2-180-10	Use VM2-180	VM2-200 VM2-200-10	Use VM2-200	Use VM2-200
Fixation screw Supplied with the posts and also available separately as a spare					

Recommended torque for entirely castable posts: 20-25 Ncm.

Entirely castable posts for Shelta implants

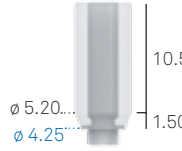
prosthetic component \emptyset	3.30	3.80	4.25	5.00
for implants	Shelta 3.80	Shelta 3.80 - 4.25 5.00 - 6.00	Shelta 4.25 - 5.00 - 6.00	Shelta 5.00 - 6.00
Castable posts in PMMA for casting Engaging Straight emergence Fixation screw included	A-CC-330-EX 	A-CC-380-EX 	-	-
Castable posts in PMMA for casting Engaging Anatomical emergence Fixation screw included	A-CCR-330-EX 	A-CCR-380-EX 	AS-CCR-425-EX 	AS-CCR-500-EX 
Castable posts in PMMA for casting Non engaging Straight emergence Fixation screw included	A-CC-330 	A-CC-380 	-	-
Castable posts in PMMA for casting Non engaging Anatomical emergence Fixation screw included	A-CCR-330 	A-CCR-380 	AS-CCR-425 	AS-CCR-500 
Single pack Pack of 10 pieces	VM2-180 VM2-180-10	Use VM2-180	Use VM2-180	Use VM2-180
Fixation screw Supplied with the posts and also available separately as a spare	 M 1.8.....			

Recommended torque for entirely castable posts: 20-25 Ncm.

Definitive single screw retained rehabilitation with castable posts with a metal base

Insert a castable engaging post with a metal base on the precision model. Tighten the post with the specific fixation screw with a screwdriver of the HSM series, applying a maximum torque of 8-10 Ncm.

Important warning

It is recommended always to use test screws for the laboratory phases and to keep the new screw supplied for the final fastening in the oral cavity.

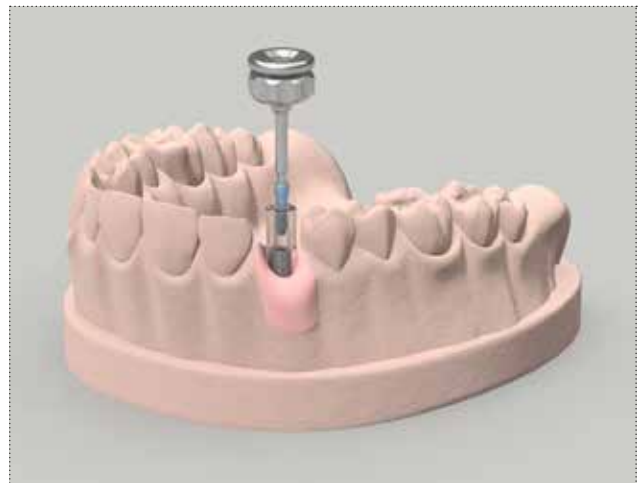

Model the post by reducing it in height and volume, as necessary.



Model the screw retained crown on the post in castable resin.

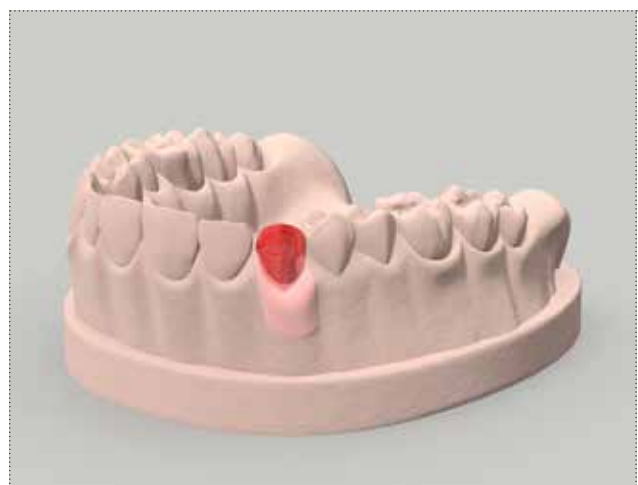

Proceed with overcasting as usual. See page 202 for advice on the correct procedure for casting alloys. Perform a test with the metallic structure on the model or in the patient's mouth to modify it, if necessary.

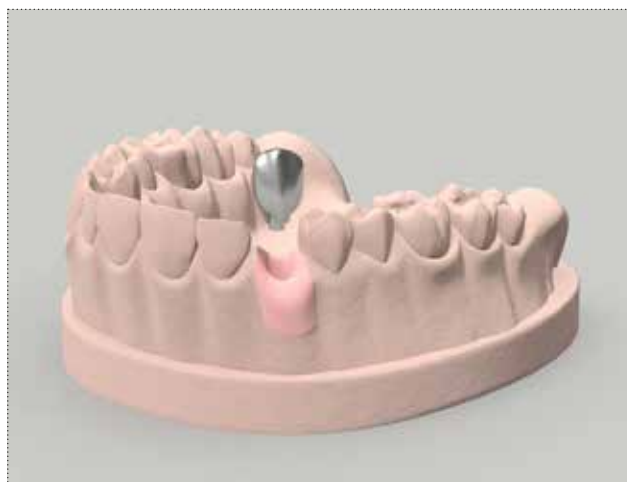

Ceramize as usual.

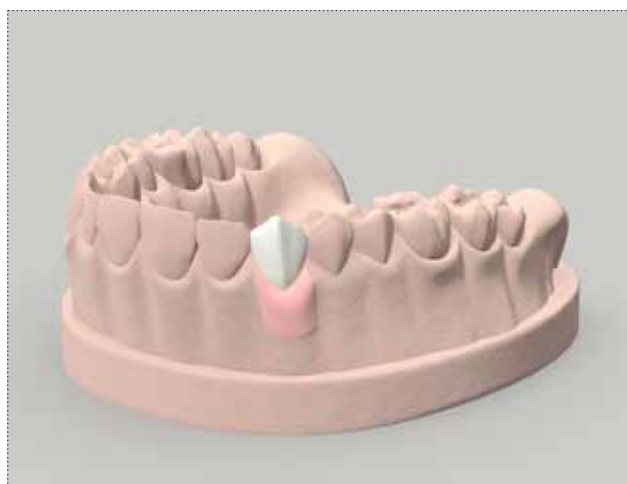

Position the screw retained crown on the implant and tighten it with the supplied screw, without exceeding a torque of 20–25 Ncm.



Definitive multiple screw retained rehabilitation with castable posts with a metal base

Insert the castable non engaging posts with a metal base on the precision model. Tighten the posts with the specific fixation screw with a screwdriver of the HSM series, applying a maximum torque of 8-10 Ncm.

Important warning

It is recommended always to use test screws for the laboratory phases and to keep the new screw supplied for the final fastening in the oral cavity.

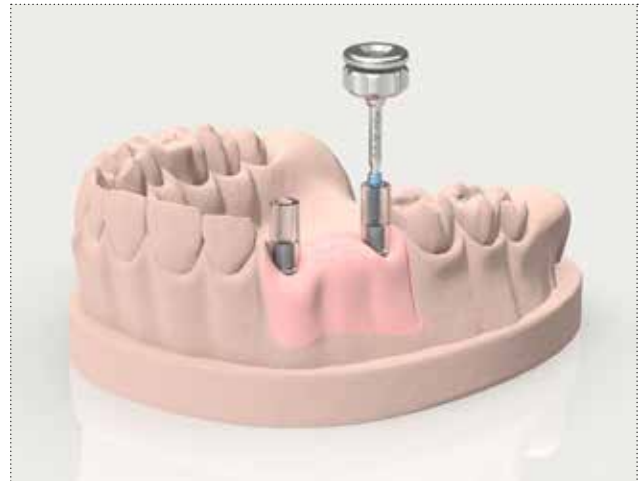

Model the posts by reducing them in height and volume, as necessary.

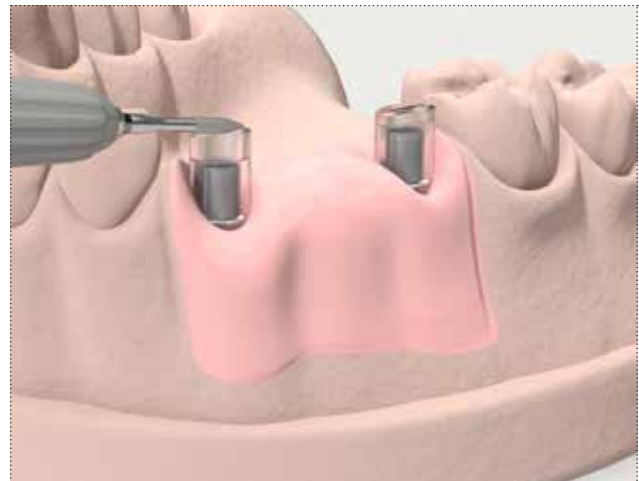

Model the screw retained bridge on the posts in castable resin.



Proceed with overcasting as usual. See page 202 for advice on the correct procedure for casting alloys. Perform a test with the metallic structure on the model or in the patient's mouth to modify it, if necessary.



Ceramize as usual.



Position the screw retained bridge on the implants and tighten it with the supplied screw, without exceeding a torque of 20–25 Ncm.



Definitive single cemented rehabilitation with a single post obtained by overcasting of a castable sleeve

Insert an engaging castable post with a metal base on the precision model. Tighten it with the specific fixation screw with a screwdriver from the HSM series, applying a maximum torque of 8-10 Ncm.

Important warning

It is recommended always to use test screws for the laboratory phases and to keep the new screw supplied for the final fastening in the oral cavity.

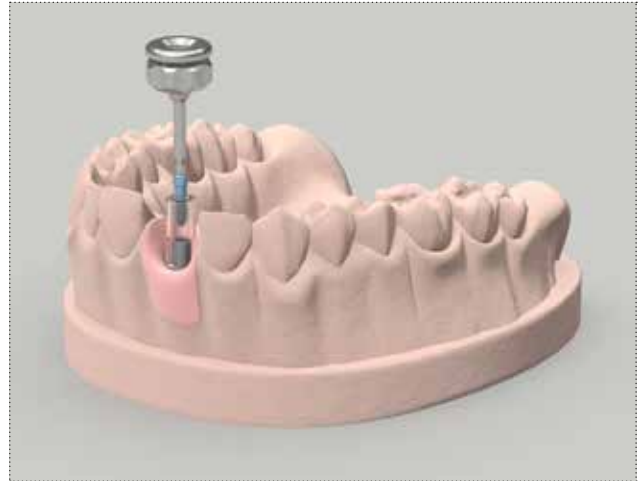

Model the post in height and volume, increasing the thicknesses if necessary. Then proceed to overcasting as usual.

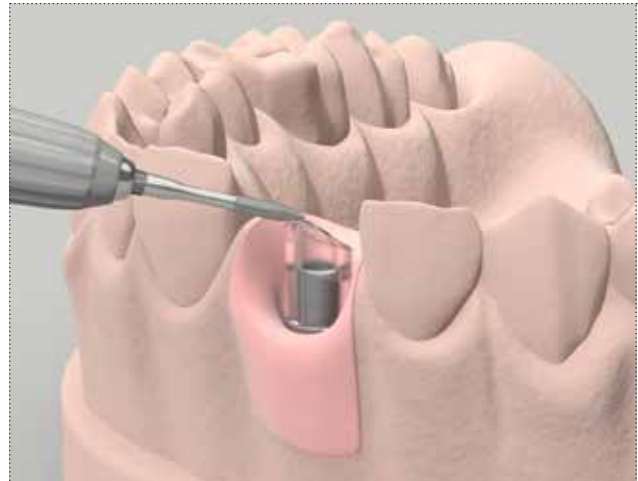

Model the cap on the post in wax or resin, leaving sufficient space for the cement.

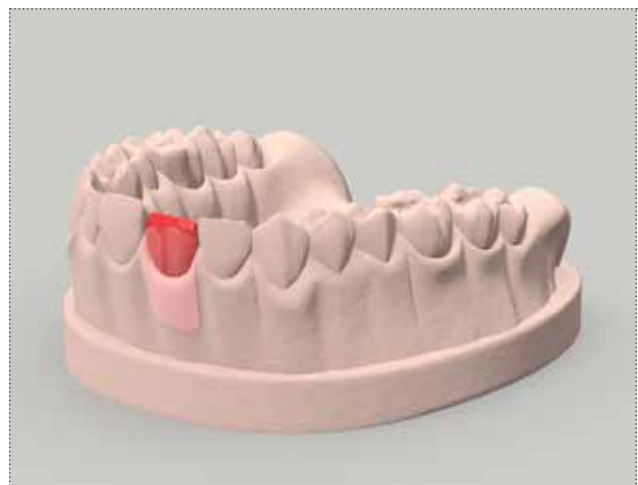

Fabricate the cap by casting or using CAD CAM technologies. Test the crown on the model to check that there is no roughness that could obstruct the correct positioning of the cap on the post, and correct it if necessary.
Cerimize the definitive prosthesis as usual.

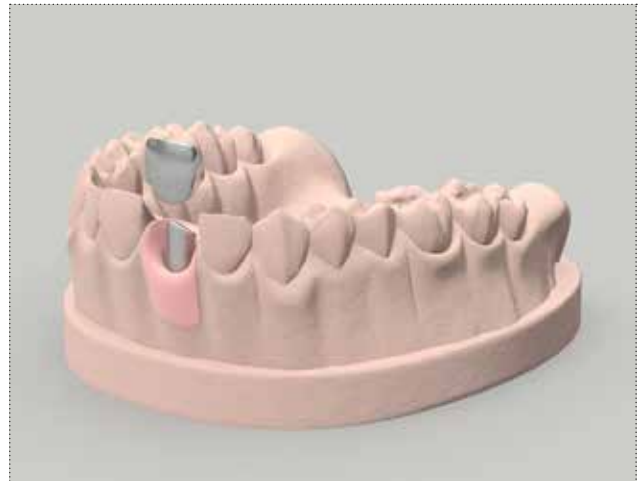

Position the post in the patient's mouth and tighten it with the supplied screw, applying a torque of 20–25 Ncm.



Cover the screw hole and cement the crown on the post, taking care to remove all the excess cement from the margin.



Definitive multiple cemented rehabilitation with single posts obtained by overcasting of castable sleeves

Insert the engaging castable posts with a metal base on the precision model. Tighten them with the specific fixation screw with a screwdriver from the HSM series, applying a maximum torque of 8-10 Ncm.

Important warning

It is recommended always to use test screws for the laboratory phases and to keep the new screw supplied for the final fastening in the oral cavity.

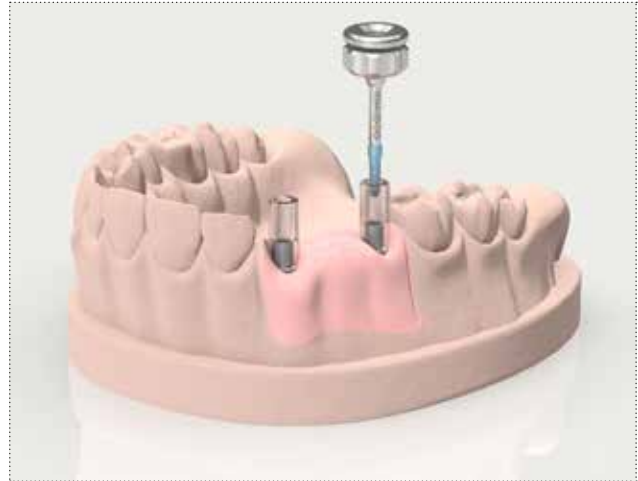

Model the posts in height and volume, increasing the thicknesses if necessary. Then proceed to overcasting as usual.

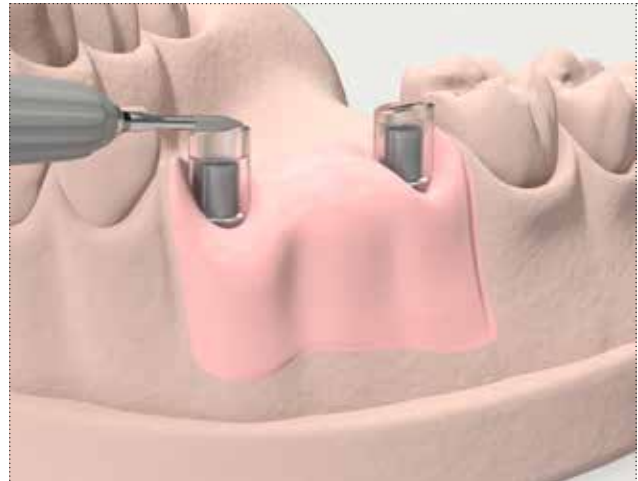

Model the bridge on the posts in wax or resin, leaving sufficient space for the cement.



Fabricate the bridge by casting or using CAD CAM technologies. Test the structure on the model to check that there is no roughness that could obstruct the correct positioning of the bridge on the posts, and correct it if necessary.
Ceramize the definitive prosthesis as usual.



Position the posts in the patient's mouth and tighten them with the supplied screw, applying a torque of 20–25 Ncm.



Cover the screw holes and cement the bridge on the posts, taking care to remove all the excess cement from the margin.







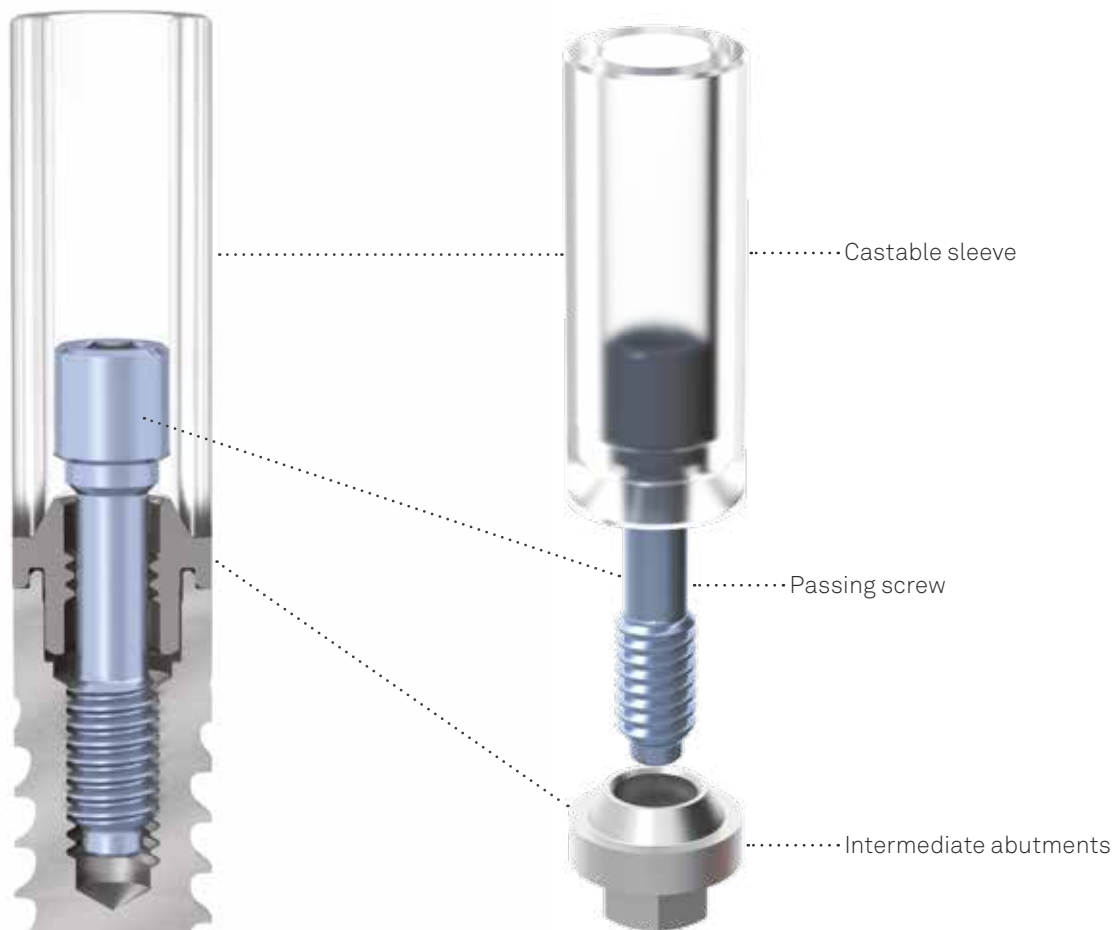



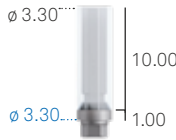
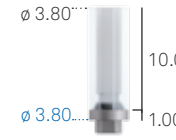
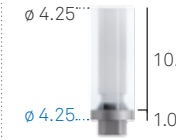



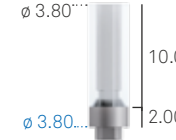
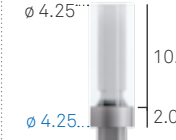

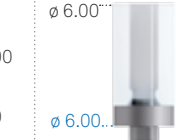

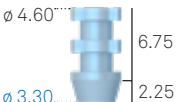

Temporary and definitive rehabilitation with intermediate abutments

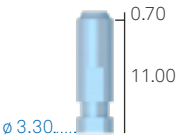
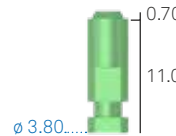
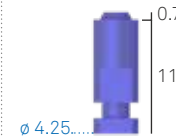
These abutments have a straight emergence profile and are made up of an engaging titanium base, characterized by a small upper cone with a height of 0.70 mm, the same for all the connection diameters, which allows easy insertion and removal of the over-structures, even in case of slight disparallelisms. The abutment is supplied with the castable sleeves for modelling and casting the over-structure and with the passing screw for the “packet” fastening of the over-structure and abutments to the implants. Optionally, when these abutments are used, the impression can be taken directly on the abutments with the specific Pick-up transfers. Titanium sleeves are also available, for the production of temporary prosthesis.

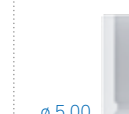
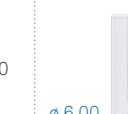

Intermediate abutments for Premium Kohno and Shelta implants

prosthetic component \varnothing	3.30	3.80	4.25	5.00	6.00
for implants	Premium 3.30 - 3.80 Kohno 3.80 Shelta 3.80	Premium 3.80 Kohno 3.80 Shelta 3.80 - 4.25 5.00 - 6.00	Premium 4.25 Kohno 4.25	Premium 5.00 Kohno 5.00	Kohno 6.00
Straight abutments with passing screw Engaging Transgingival H. 1.00 mm Fixation screw included	A-ABU-330-1 	A-ABU-380-1 	A-ABU-425-1 	A-ABU-500-1 	A-ABU-600-1 
Straight abutments with passing screw Engaging Transgingival H. 2.00 mm Fixation screw included	A-ABU-330-2 	A-ABU-380-2 	A-ABU-425-2 	A-ABU-500-2 	A-ABU-600-2 
Fixation screw for abutments Supplied with the abutments, it can also be ordered separately as a spare	A-VABU-180 	Use A-VABU-180	A-VABU-200 	Use A-VABU-200	Use A-VABU-200
Pick-up transfers for intermediate abutments Non engaging Fixation screw included	A-TRABU-330 	A-TRABU-380 	A-TRABU-425 	-	-
Single pack Spare screw for abutment transfers of intermediate abutments Supplied with the transfer, it can also be ordered separately as a spare	A-VTRABU-180 	Use A-VTRABU-180	A-VTRABU-200 	Use A-VTRABU-200	Use A-VTRABU-200
Analog for intermediate abutments Non engaging	A-ANABU-330 	A-ANABU-380 	A-ANABU-425 	-	-
Single pack Titanium sleeves Fixation screw included	-	A-CTABU-380-ROT 	A-CTABU-425-ROT 	-	-
Single pack Spare castable sleeves in PMMA Fixation screw not included	A-CCABU-330-ROT 	A-CCABU-380-ROT 	A-CCABU-425-ROT 	A-CCABU-500-ROT 	A-CCABU-600-ROT 

Recommended torque for transfer screws: 8-10 Ncm. Recommended torque for intermediate abutments: 20-25 Ncm.
See technical characteristics of Gr. 5 titanium and PMMA on pages 196 and 198.

Impression and model phase

After inserting the implants, place the intermediate abutments on the transfers of the same diameter and screw them with the supplied passing screw (cod. A-VTRABU-*) at a maximum torque of 8-10 Ncm.

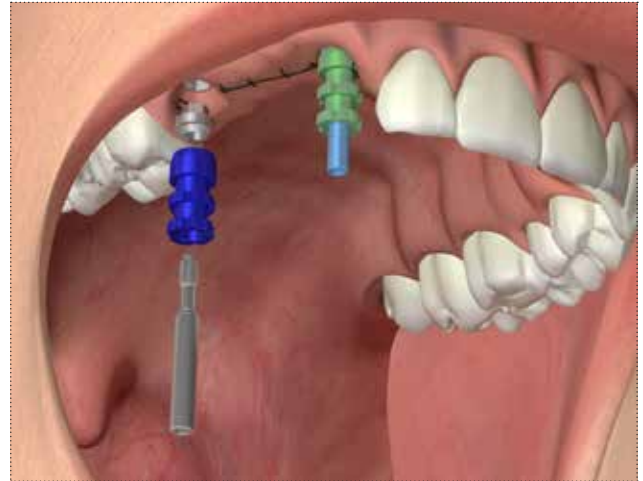

If desired, fix the transfers together with wire and resin or composite, and wait for polymerization to be completed, as indicated by the manufacturer (e.g. SUN resin, code SUN-A2 or SUN-A3).

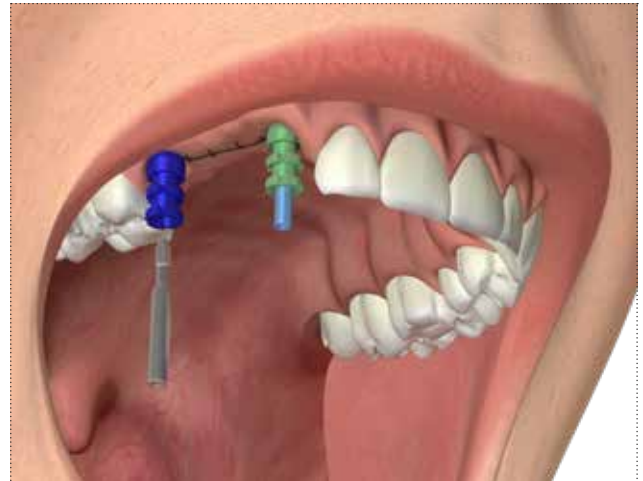

Check that the personalized tray, when placed in the mouth, contains the entire height of the transfers inside its walls, and that the summit of the transfer screws emerges for a suitable length from the respective holes in the tray.

Inject a precision impression material (i.e. SKY IMPLANT LIGHT, code SKY14) only around the transfers. Fill the impression tray with a more consistent material (i.e. SKY IMPLANT ONEMIX-ED, code SKY08) along the entire arch. Then position the tray *in situ* and wait for the hardening times as indicated by the instructions.



Unscrew the transfer screws and remove them from the impression. Remove the tray: the Pick-up transfers will remain incorporated in the impression; take care to remove manually the intermediate abutments, to prevent screws and abutments from accidentally falling into the patient's mouth when the impression tray is removed.



Screw the laboratory analogs of the abutments to the transfers using the transfer screws, repositioned in the holes left by each screw in the impression material. The recommended torque is 8–10 Ncm. Cast the model as usual.



Temporary multiple screw retained rehabilitation with intermediate abutments

In the patient's mouth lean the intermediate abutments on the titanium sleeves and screw them together to the implant, with the specific screw.
The recommended torque is 8-10 Ncm.

Important warning

It is recommended always to use test screws for the laboratory phases and to keep the new screw supplied for the final fastening in the oral cavity.



Insert a pre-made pierced bridge made in the laboratory onto the titanium sleeves so as to allow it to slide easily on the body of the sleeves. Mark the palatal and vestibular margin of the temporary bridge on both sleeves, in order to reduce them appropriately.



Remove the temporary bridge and cut the sleeves at the height marked, using an abrasive disk.



After the tightening of the intermediate abutments together with the titanium sleeves to the implants, with the supplied passing screw (not exceeding the torque of 20-25 Ncm), lute the temporary bridge to the sleeves and remove the excess material.



Insert teflon, gutta-percha or soft cement into the screw hole of the sleeves and close the top with resin or a composite material.



Definitive multiple screw retained rehabilitation with intermediate abutments

Tighten the castable sleeves to the analogs of intermediate abutments on the precision model, using a screwdriver of the HSM series. The tightening torque is 8-10 Ncm. The prosthetic screw (cod. A-VABU-*) secures with a "packet" fastening the castable sleeve and the analog of the abutment.

Important warning

It is recommended always to use test screws for the laboratory phases and to keep the new screw supplied for the final fastening in the oral cavity.

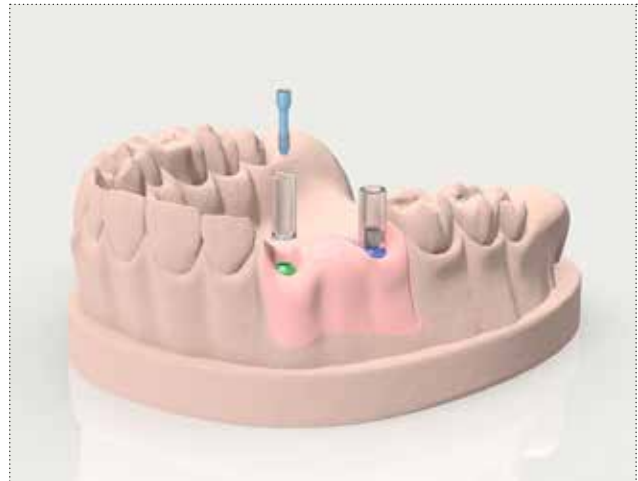

Reduce and modify the castable sleeves to a size compatible with the patient's vertical dimension.

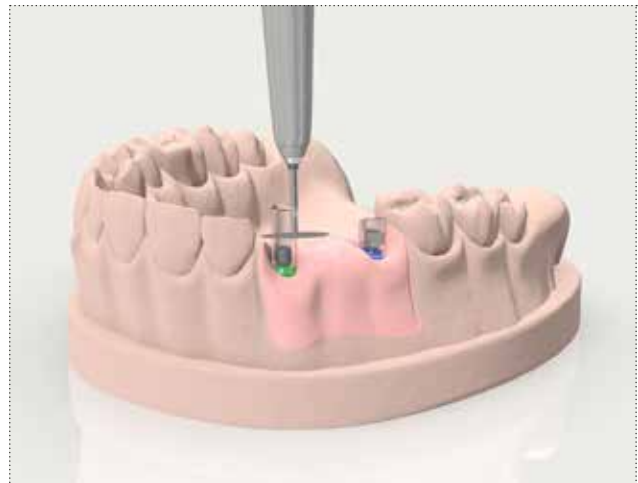

Model the screw retained bridge in castable resin on the sleeves.



Fabricate the bridge by casting or using CAD CAM technologies. Test the structure on the model to check that there is no roughness that could obstruct the correct positioning of the bridge on the posts, and correct it if necessary.



Ceramize as usual.



Remove the temporary prosthesis from the patient's mouth, preventing them from accidentally falling into the oral cavity. Place the intermediate abutments on the final ceramic prosthesis and engage the hexagon in the connection of the implants. Then screw it, applying a torque of 20-25 Ncm and check for passivation and occlusal relationships.



Temporary and definitive rehabilitation with PLAIN abutments







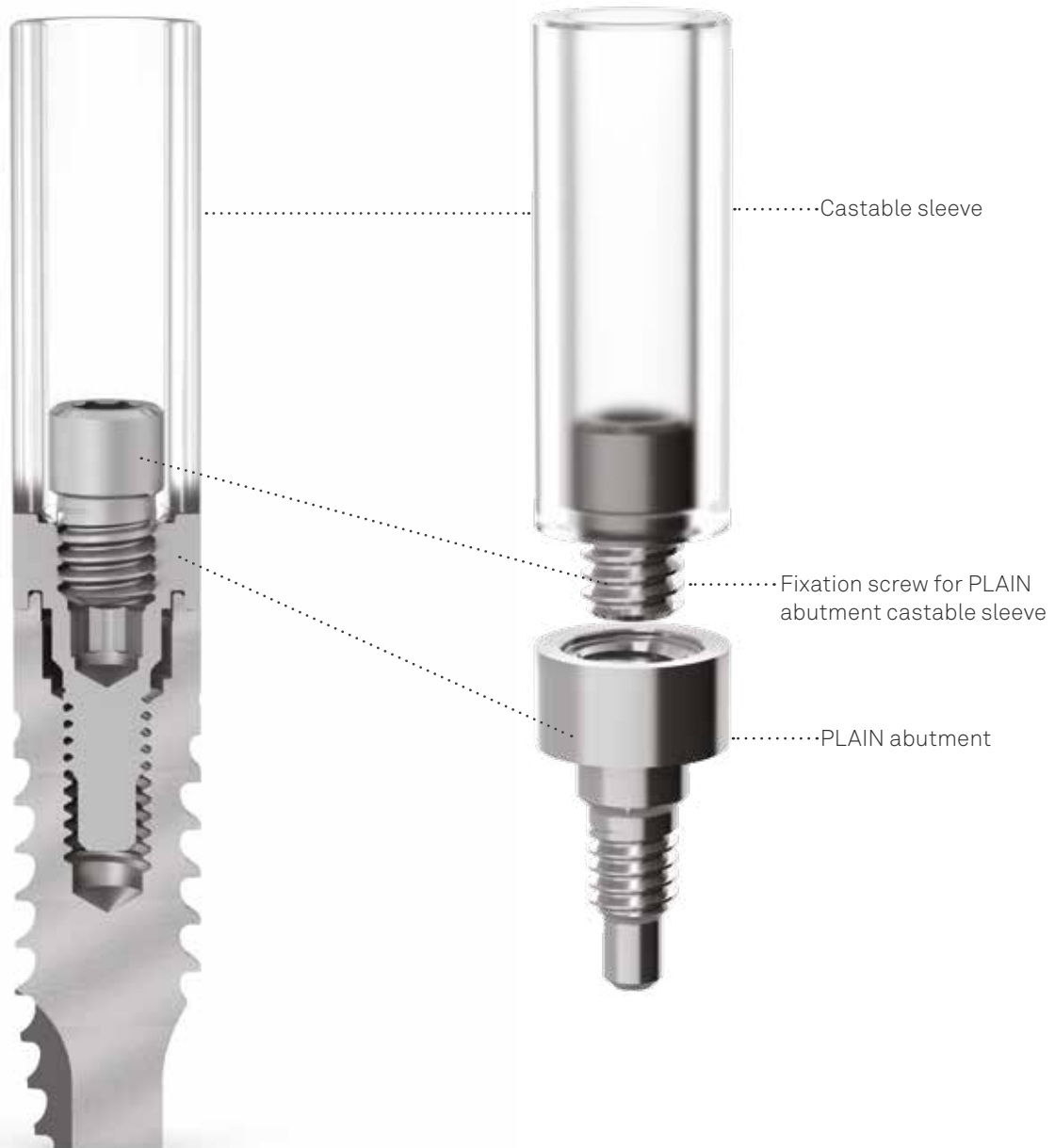





The PLAIN abutments, whose peculiarity is the direct tightening to the implants, use the completely flat geometry of the upper section, which is coupled to the special castable sleeves by means of a small guide. The utility of these abutments is therefore that they maximize centring and repositioning operations with structures screw retained on multiple implants.

For the transport into the oral cavity, the screwing and the final fastening of PLAIN abutments, the standard screwdrivers from the HSM series contained in the Premium Kohno and Shelta surgical kit must be used. The insertion torque is 25-30 Ncm to screw the abutment to the implant and 20-25 Ncm to tighten the prosthetic screw. Normally, when these abutments are used, the impression is taken directly on the abutments with the specific transfers.

Titanium sleeves are also available, for the production of temporary prosthesis.

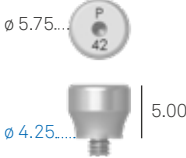

PLAIN abutments for Premium Kohno implants

prosthetic component \emptyset	3.30	3.80	4.25	5.00
for implants	Premium 3.30 - 3.80 Kohno 3.80	Premium 3.80 Kohno 3.80	Premium 4.25 Kohno 4.25	Premium 5.00 Kohno 5.00 - 6.00
Direct screw retained PLAIN abutment Transgingival H. 2.00 mm	A-PLAIN-ABU330-2 	A-PLAIN-ABU380-2 	A-PLAIN-ABU425-2 	A-PLAIN-ABU500-2 
Direct screw retained PLAIN abutment Transgingival H. 3.00 mm	A-PLAIN-ABU330-3 	A-PLAIN-ABU380-3 	A-PLAIN-ABU425-3 	A-PLAIN-ABU500-3 
Direct screw retained PLAIN abutment Transgingival H. 4.00 mm	A-PLAIN-ABU330-4 	A-PLAIN-ABU380-4 	A-PLAIN-ABU425-4 	A-PLAIN-ABU500-4 
Healing cap for PLAIN abutment	A-PLAIN-CG330 	A-PLAIN-CG380 	A-PLAIN-CG425 	A-PLAIN-CG500 

Recommended torque for PLAIN abutments: 25-30 Ncm.

Recommended torque for healing caps: 8-10 Ncm.









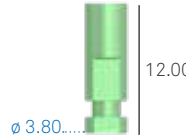
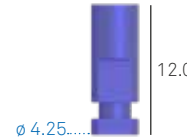

PLAIN abutments for Shelta implants

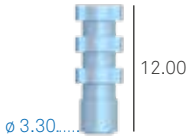
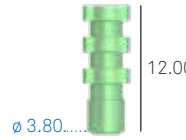
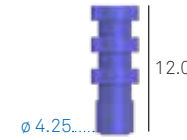
prosthetic component \emptyset	3.30	3.80	4.25	5.00
for implants	Shelta 3.80	Shelta 3.80 - 4.25 5.00 - 6.00	Shelta 4.25 - 5.00 - 6.00	Shelta 5.00 - 6.00
Direct screw retained PLAIN abutment Transgingival H. 2.00 mm	A-PLAIN-ABU330-2 	A-PLAIN-ABU380-2 	AS-PLAIN-ABU425-2 	AS-PLAIN-ABU500-2 
Direct screw retained PLAIN abutment Transgingival H. 3.00 mm	A-PLAIN-ABU330-3 	A-PLAIN-ABU380-3 	AS-PLAIN-ABU425-3 	AS-PLAIN-ABU500-3 
Direct screw retained PLAIN abutment Transgingival H. 4.00 mm	A-PLAIN-ABU330-4 	A-PLAIN-ABU380-4 	AS-PLAIN-ABU425-4 	AS-PLAIN-ABU500-4 
Healing cap for PLAIN abutment	A-PLAIN-CG330 	A-PLAIN-CG380 	A-PLAIN-CG425 	A-PLAIN-CG500 

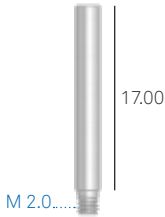
Recommended torque for PLAIN abutments: 25-30 Ncm.

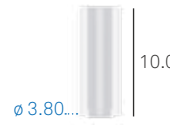
Recommended torque for healing caps: 8-10 Ncm.

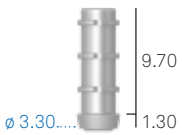
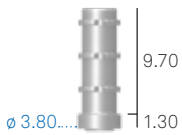
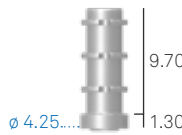
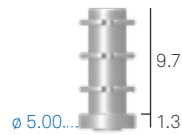
PLAIN abutment components for Premium Kohno and Shelta implants

prosthetic component \varnothing	3.30	3.80	4.25	5.00
for implants	Premium 3.30 - 3.80 Kohno 3.80 Shelta 3.80	Premium 3.80 Kohno 3.80 Shelta 3.80	Premium 4.25 Kohno 4.25 Shelta 4.25	Premium 5.00 Kohno 5.00 - 6.00 Shelta 5.00 - 6.00
Analog for PLAIN abutment	A-PLAIN-ANA-330  \varnothing 3.30... 12.00	A-PLAIN-ANA-380  \varnothing 3.80... 12.00	A-PLAIN-ANA-425  \varnothing 4.25... 12.00	A-PLAIN-ANA-500  \varnothing 5.00... 12.00
Pick-up transfer for PLAIN abutment	A-PLAIN-TRA-330  \varnothing 3.30... 12.00	A-PLAIN-TRA-380  \varnothing 3.80... 12.00	A-PLAIN-TRA-425  \varnothing 4.25... 12.00	A-PLAIN-TRA-500  \varnothing 5.00... 12.00
Spare screw for PLAIN transfer Supplied with the transfers for PLAIN abutments, it can also be ordered separately as a spare	A-PLAIN-VTRA200  M 2.0... 17.00	Use A-PLAIN-VTRA200	Use A-PLAIN-VTRA200	Use A-PLAIN-VTRA200
Castable sleeve for PLAIN abutments Fixation screw included	A-PLAIN-CC330  \varnothing 3.30... 10.00	A-PLAIN-CC380  \varnothing 3.80... 10.00	A-PLAIN-CC425  \varnothing 4.25... 10.00	A-PLAIN-CC500  \varnothing 5.00... 10.00
Titanium sleeve for PLAIN abutments Fixation screw included	A-PLAIN-CT330  \varnothing 3.30... 9.70 1.30	A-PLAIN-CT380  \varnothing 3.80... 9.70 1.30	A-PLAIN-CT425  \varnothing 4.25... 9.70 1.30	A-PLAIN-CT500  \varnothing 5.00... 9.70 1.30
Single pack Pack of 10 pieces Fixation screw for PLAIN abutment castable sleeve Supplied with the sleeves, it can also be ordered separately as a spare	A-PLAIN-VP200 A-PLAIN-VP200-10  M 2.0...	Use A-PLAIN-VP200	Use A-PLAIN-VP200	Use A-PLAIN-VP200

Recommended torque for transfer screws: 8-10 Ncm.

Recommended torque for fixation screws: 20-25 Ncm.

Impression and model phase

After inserting the implants, screw in the PLAIN abutments using a screwdriver of the HSM series. The tightening torque of PLAIN abutments onto implants is 25–30 Ncm.



Screw a transfer of the series A-PLAIN-TRA-* onto every PLAIN abutment, using the supplied screw and a screwdriver of the HSM series. The tightening torque of the transfers on the PLAIN abutments is 8–10 Ncm.

If desired, fix the transfers together with wire and resin or composite, and wait for polymerization to be completed, as indicated by the manufacturer (e.g. SUN resin, code SUN-A2 or SUN-A3).

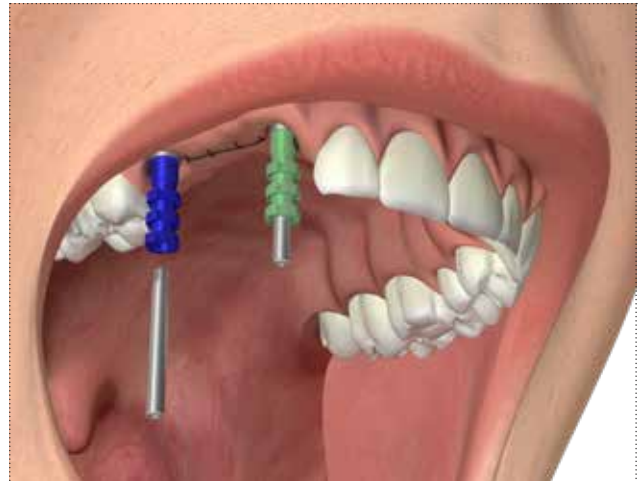

Check that the personalized tray, when placed in the mouth, contains the entire height of the transfers inside its walls, and that the summit of the transfer screws emerges for a suitable length from the respective holes in the tray.

Inject a precision impression material (i.e. SKY IMPLANT LIGHT, code SKY14) only around the transfers. Fill the impression tray with a more consistent material (i.e. SKY IMPLANT ONEMIX-ED, code SKY08) along the entire arch. Then position the tray *in situ* and wait for the hardening times as indicated by the instructions.



Unscrew the transfer screws and remove them from the impression to prevent them from accidentally falling into the patient's mouth when the impression tray is removed. Remove the tray: the Pick-up transfers remain incorporated in the impression.



Screw the titanium healing caps onto the PLAIN abutments using a screwdriver of the HSM series. The tightening torque for PLAIN healing caps on their respective abutments is 8–10 Ncm.



Screw the PLAIN analogs (code A-PLAIN-ANA-*) onto the transfers using the transfer screws, repositioned in the holes left by each screw in the impression material. The recommended torque is 8–10 Ncm. Develop the model as usual.



Multiple temporary screw retained rehabilitation with PLAIN abutments: luting technique with titanium sleeves

Screw the titanium sleeves onto the PLAIN analogs on the precision model using the fixation screw A-PLAIN-VP200, leaving it initially at the original length. The recommended torque is 8-10 Ncm.

Important warning

It is recommended always to use test screws for the laboratory phases and to keep the new screw supplied for the final fastening in the oral cavity.

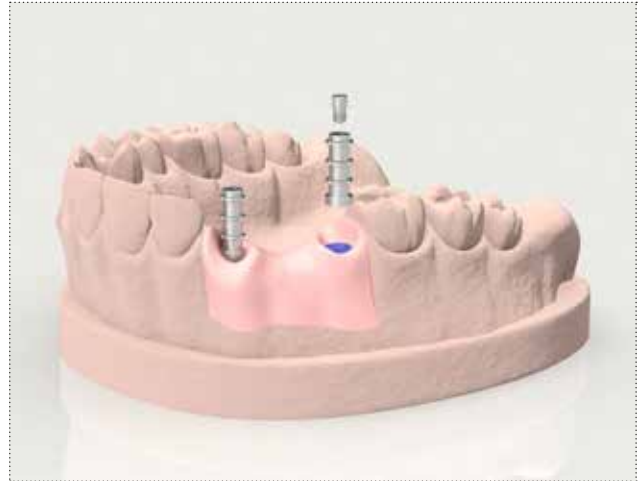

On the PLAIN titanium sleeves insert a pre-made pierced bridge made in the laboratory so as to allow it to slide easily on the body of the sleeves. Mark the palatal and vestibular margin of the temporary bridge on both sleeves, then reduce them appropriately.



Remove the temporary bridge and cut the posts at the height marked, using an abrasive disk.

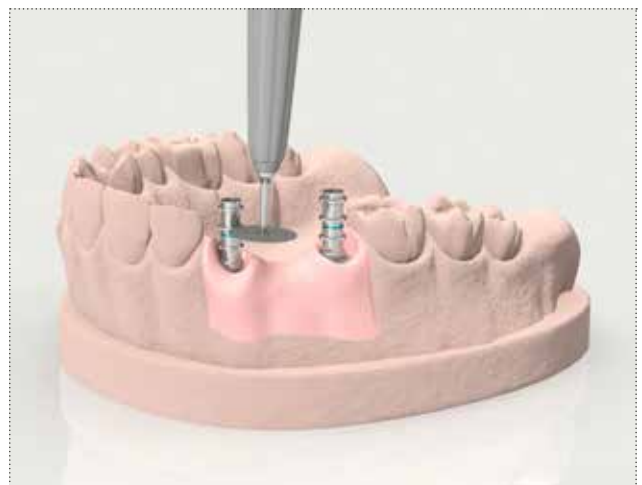

Lute the temporary bridge onto the PLAIN titanium sleeves, waiting for polymerization as indicated by the instructions.



When polymerization is complete, unscrew the temporary bridge from the model and tighten it onto the implants, taking care to keep the flaps of soft tissues away from the connection during insertion procedures and suturing them around the emergence of the posts to permit adequate conditioning. The temporary bridge must be tightened on using the specific screws and a screwdriver from the HSM series. A tightening torque of 20-25 Ncm must not be exceeded.



Insert teflon, gutta-percha or soft cement into the screw hole of the PLAIN sleeves and close the top with resin or a composite material.

The temporary bridge will help not only to ensure an adequate quality of life for the patient while waiting for the definitive prosthesis, but also the correct conformation of the soft tissues that will later receive the definitive prosthesis with excellent aesthetic results.

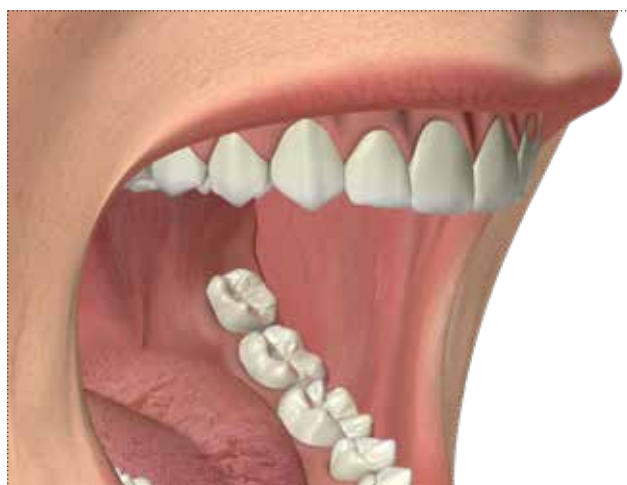

Multiple temporary screw retained rehabilitation with PLAIN abutments: total casting technique with castable sleeves

Screw the castable sleeves onto the PLAIN analogs on the precision model, using the fixation screw A-PLAIN-VP200, leaving it initially at the original length. The recommended torque is 8-10 Ncm.

Important warning

It is recommended always to use test screws for the laboratory phases and to keep the new screw supplied for the final fastening in the oral cavity.

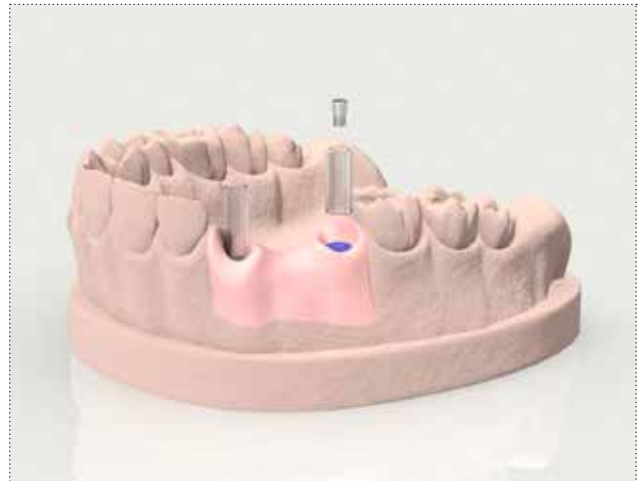

Reduce the castable sleeves to a size compatible with the patient's vertical dimension with an abrasive disk.



Model a structure in wax or castable resin on the sleeves.



Cast the structure according to the standard protocol.
Test the structure first on the model and then in the patient's mouth, checking for its complete passivity.



Ceramize the final prosthesis as usual.
Remove the over-structure from the model.



Unscrew the PLAIN healing caps and tighten the over-structure on the PLAIN abutments, applying a torque of 20-25 Ncm.
Check for passivation and occlusal relationships.



Temporary and definitive rehabilitation with P.A.D. abutments







The P.A.D. system has been developed to facilitate the production of multiple screw retained prostheses. The different versions available, with angles of 17° and 30°, make the prosthetic repositioning of connections possible even in case of particularly divergent and disparallel implants. This characteristic is enhanced by an additional 15° cone positioned above the P.A.D. platform, which further facilitates the insertion of multiple structures. Angled P.A.D. abutments must be transported into the patient's mouth using the specific transfer screw for manual screwing PAD-VTRAL-140-MAN or the PAD-CAR transporter with a transfer screw, also made of titanium, to fix the abutment to the instrument.

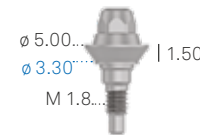
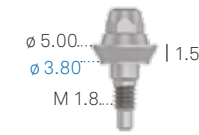
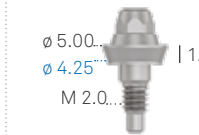
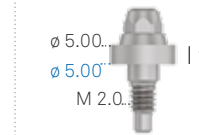
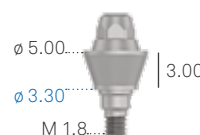

The upper cone allows the prosthetic structure to be up to 15° on each side, which in the case of angled P.A.D. abutments is added to the inclination of 17° or 30°. This characteristic allows disparallelisms of up to 45° to be easily managed

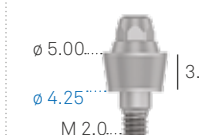
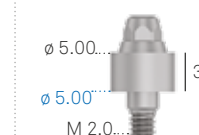

Straight P.A.D. abutments for Premium Kohno implants

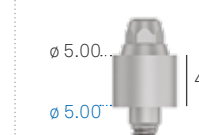
prosthetic component \varnothing	3.30	3.80	4.25	5.00
for implants	Premium 3.30 - 3.80 Kohno 3.80	Premium 3.80 Kohno 3.80	Premium 4.25 Kohno 4.25	Premium 5.00 Kohno 5.00 - 6.00
Straight P.A.D. abutments Direct screw retained Transgingival H. 1.50 mm	A-PAD-AD330-15 	A-PAD-AD380-15 	A-PAD-AD425-15 	A-PAD-AD500-15 
Straight P.A.D. abutments Direct screw retained Transgingival H. 3 mm	A-PAD-AD330-30 	A-PAD-AD380-30 	A-PAD-AD425-30 	A-PAD-AD500-30 
Straight P.A.D. abutments Direct screw retained Transgingival H. 4 mm	A-PAD-AD330-40 	A-PAD-AD380-40 	A-PAD-AD425-40 	A-PAD-AD500-40 

Recommended torque for straight P.A.D. abutments: 25-30 Ncm.

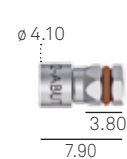
description	code
Screwdriver for straight P.A.D. abutments, with hexagonal connector for dynamometric key	AVV2-ABUT 









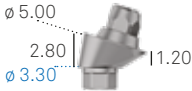
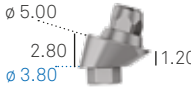
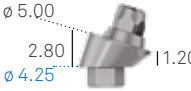
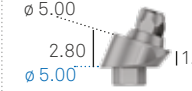
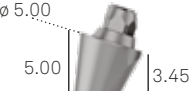
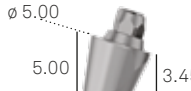

Important warning

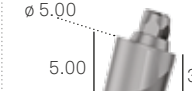
All drivers for use with a ratchet have a red polymer O-ring inside the connection hexagon, to ensure adequate grip for instruments and therefore the correct position of components. This O-ring must be checked periodically and replaced when worn or no longer able to ensure the correct grip.

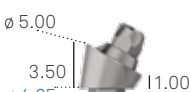

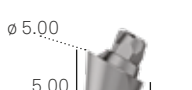
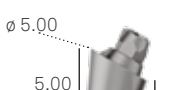
A kit of 5 spare O-rings is available, with order code **ORING180-088**.

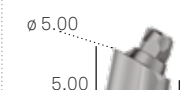

Angled P.A.D. abutments for Premium Kohno implants

prosthetic component \varnothing	3.30	3.80	4.25	5.00
for implants	Premium 3.30 - 3.80 Kohno 3.80	Premium 3.80 Kohno 3.80	Premium 4.25 Kohno 4.25	Premium 5.00 Kohno 5.00
P.A.D. abutment Angled at 17° Transgingival H. 3 mm Fixation screw included	A-PAD-AA330-173 	A-PAD-AA380-173 	A-PAD-AA425-173 	A-PAD-AA500-173 
P.A.D. abutment Angled at 17° Transgingival H. 5 mm Fixation screw included	A-PAD-AA330-175 	A-PAD-AA380-175 	A-PAD-AA425-175 	A-PAD-AA500-175 
P.A.D. abutment Angled at 30° Transgingival H. 3 mm Fixation screw included	A-PAD-AA330-303 	A-PAD-AA380-303 	A-PAD-AA425-303 	A-PAD-AA500-303 
P.A.D. abutment Angled at 30° Transgingival H. 5 mm Fixation screw included	A-PAD-AA330-305 	A-PAD-AA380-305 	A-PAD-AA425-305 	A-PAD-AA500-305 
Single pack Pack of 10 pieces Fixation screw Supplied with angled P.A.D. abutments, it can also be ordered separately as a spare	PAD-VM-180 PAD-VM-180-10 	Use PAD-VM-180	PAD-VM-200 PAD-VM-200-10 	Use PAD-VM-200

Recommended torque for angled P.A.D. abutments: 20-25 Ncm.

description	code
P.A.D. transfer screw for manual screwing, to be used as a carrier to transport angled P.A.D. in the oral cavity, sterilizable and reusable	PAD-VTRAL-140-MAN 
Carrier for transport of angled P.A.D. abutments into the oral cavity, sterilizable and reusable. (Not included in the surgical kit, included in the Screw Kit, it can also be ordered separately).	PAD-CAR 

Straight P.A.D. abutments for Shelta implants

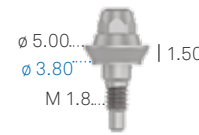
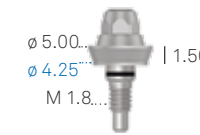
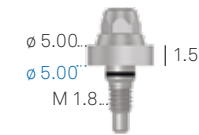
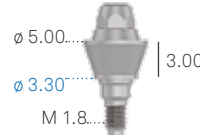
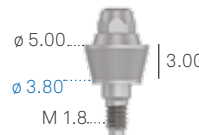
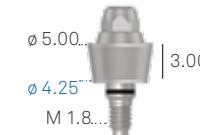
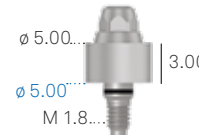
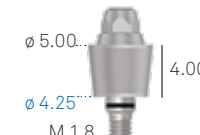
prosthetic component ø	3.30	3.80	4.25	5.00
for implants	Shelta 3.80	Shelta 3.80 - 4.25 5.00 - 6.00	Shelta 4.25 - 5.00 - 6.00	Shelta 5.00 - 6.00
Straight P.A.D. abutments Direct screw retained Transgingival H. 1.50 mm	A-PAD-AD330-15 	A-PAD-AD380-15 	AS-PAD-AD425-15 	AS-PAD-AD500-15 
Straight P.A.D. abutments Direct screw retained Transgingival H. 3 mm	A-PAD-AD330-30 	A-PAD-AD380-30 	AS-PAD-AD425-30 	AS-PAD-AD500-30 
Straight P.A.D. abutments Direct screw retained Transgingival H. 4 mm	A-PAD-AD330-40 	A-PAD-AD380-40 	AS-PAD-AD425-40 	AS-PAD-AD500-40 

Recommended torque for straight P.A.D. abutments: 25-30 Ncm.

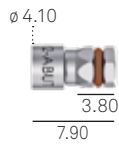
description	code
Screwdriver for straight P.A.D. abutments, with hexagonal connector for dynamometric key	AVV2-ABUT 







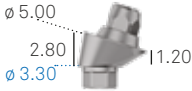
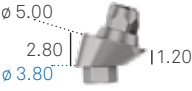

Important warning

All drivers for use with a ratchet have a red polymer O-ring inside the connection hexagon, to ensure adequate grip for instruments and therefore the correct position of components. This O-ring must be checked periodically and replaced when worn or no longer able to ensure the correct grip.

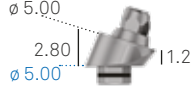
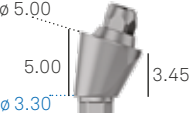
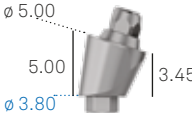
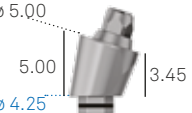
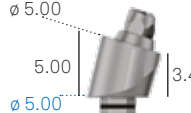
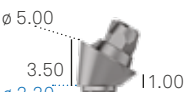
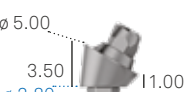

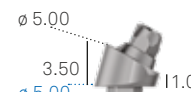
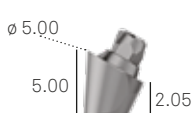
A kit of 5 spare O-rings is available, with order code **ORING180-088**.

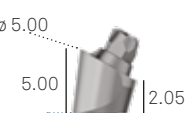







Angled P.A.D. abutments for Shelta implants







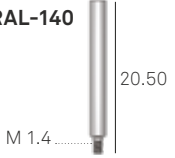
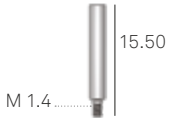
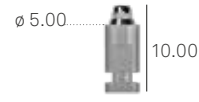

prosthetic component \emptyset	3.30	3.80	4.25	5.00
for implants	Shelta 3.80	Shelta 3.80 - 4.25 5.00 - 6.00	Shelta 4.25 - 5.00 - 6.00	Shelta 5.00 - 6.00
P.A.D. abutment Angled at 17° Transgingival H. 3 mm Fixation screw included	A-PAD-AA330-173 	A-PAD-AA380-173 	AS-PAD-AA425-173 	AS-PAD-AA500-173 
P.A.D. abutment Angled at 17° Transgingival H. 5 mm Fixation screw included	A-PAD-AA330-175 	A-PAD-AA380-175 	AS-PAD-AA425-175 	AS-PAD-AA500-175 
P.A.D. abutment Angled at 30° Transgingival H. 3 mm Fixation screw included	A-PAD-AA330-303 	A-PAD-AA380-303 	AS-PAD-AA425-303 	AS-PAD-AA500-303 
P.A.D. abutment Angled at 30° Transgingival H. 5 mm Fixation screw included	A-PAD-AA330-305 	A-PAD-AA380-305 	AS-PAD-AA425-305 	AS-PAD-AA500-305 
Single pack Pack of 10 pieces Fixation screw Supplied with angled P.A.D. abutments, it can also be ordered separately as a spare	PAD-VM-180 PAD-VM-180-10 	Use PAD-VM-180	Use PAD-VM-180	Use PAD-VM-180

Recommended torque for angled P.A.D. abutments: 20-25 Ncm.

description	code
P.A.D. transfer screw for manual screwing, to be used as a carrier to transport angled P.A.D. in the oral cavity, sterilizable and reusable	PAD-VTRAL-140-MAN 
Carrier for transport of angled P.A.D. abutments into the oral cavity, sterilizable and reusable. (Not included in the surgical kit, included in the Screw Kit, it can also be ordered separately).	PAD-CAR 

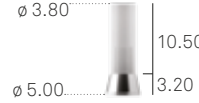
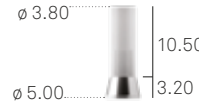
P.A.D. components for over-structures

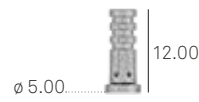
description	code
<p>Healing cap for P.A.D. abutments in Gr. 5 titanium, to be used if abutments are not fitted immediately with a temporary prosthesis Fixation screw included (code PAD-VP-140), and also available as a spare, to be tightened with a torque of 8–10 Ncm</p>	<p>PAD-CG</p> 
<p>Healing cap for P.A.D. abutments in PEEK, to be used if abutments are not fitted immediately with a temporary prosthesis Fixation screw included (code PAD-VP-140), and also available as a spare, to be tightened with a torque of 8–10 Ncm</p>	<p>PAD-CGP</p> 
<p>Rotating caps in POM for direct impression on P.A.D. abutments</p>	<p>PAD-CAP</p> 
<p>Non rotating caps in POM for direct impression on P.A.D. abutments, with hexagon</p>	<p>PAD-CAP-EX</p> 
<p>Pick-up transfer in Gr. 5 titanium for P.A.D. abutments, rotating Long transfer screw included (code PAD-VTRAL-140), suitable for taking impression with an individual open tray, and also available as a spare part</p>	<p>PAD-TRA</p> 
<p>Pick-up transfer in Gr. 5 titanium for P.A.D. abutments, with hexagon, non rotating Long transfer screw included (code PAD-VTRAL-140), suitable for taking impression with an individual open tray, and also available as a spare part</p>	<p>PAD-TRA-EX</p> 
<p>Spare screw for transfer for P.A.D. abutments, long Supplied with transfers and also available separately as a spare</p>	<p>PAD-VTRAL-140</p> 
<p>Transfer screw for P.A.D. abutments, short Also available separately as a spare</p>	<p>PAD-VTRA-140</p> 
<p>Analog for P.A.D. abutments in Gr. 5 titanium</p>	<p>PAD-ANA</p> 

description	code
<p>Castable sleeves in PMMA for P.A.D. abutments, rotating. Fixation screw included Caution: The recommended torque for tightening all over-structures obtained by casting onto abutments is 20–25 Ncm. Care must be taken during laboratory work, before casting, to avoid tightening totally castable sleeves onto models with a torque greater than 8–10 Ncm, because polymers are weaker than metal</p>	<p>PAD-CC</p> 
<p>Castable sleeves in PMMA for P.A.D. abutments, with hexagon, non-rotating. Fixation screw included Caution: The recommended torque for tightening all over-structures obtained by casting onto abutments is 20–25 Ncm. Care must be taken during laboratory work, before casting, to avoid tightening totally castable sleeves onto models with a torque greater than 8–10 Ncm, because polymers are weaker than metal</p>	<p>PAD-CC-EX</p> 
<p>Sleeves in conventional PEEK for P.A.D. abutments, rotating These are intended for temporary prostheses or for any necessary relining of a previous prosthesis for use as a temporary one Fixation screw included, to be tightened with a torque of 20–25 Ncm</p>	<p>PAD-CP</p> 
<p>Sleeves in conventional PEEK for P.A.D. abutments, with hexagon, non-rotating These are intended for temporary prostheses or for any necessary relining of a previous prosthesis for use as a temporary one Fixation screw included, and also available as a spare, to be tightened with a torque of 20–25 Ncm</p>	<p>PAD-CP-EX</p> 
<p>Castable posts in PMMA with a pre-formed base in gold alloy 1, rotating, not repositionable, for overcasting on P.A.D. abutments. Fixation screw included, to be tightened with a torque of 20–25 Ncm The screw head must never rest directly on the PMMA, but always on the alloy base The castable sleeve is also available separately as a spare part (code A-CCUCR-330)</p>	<p>PAD-UC</p> 
<p>Castable posts in PMMA with pre-formed base in cobalt-chrome, rotating, not repositionable, for overcasting on P.A.D. abutments Fixation screw included, to be tightened with a torque of 20–25 Ncm The screw head must never rest directly on the PMMA, but always on the alloy base The castable sleeve is also available separately as a spare part (code A-CCUCR-330)</p>	<p>PAD-UCRCO</p> 
<p>Spare screw for prosthetic components for P.A.D. abutments Supplied together with all components for the over-structure production, and also available as a spare part Also available in packs of 10 pieces (code PAD-VP-140-10)</p>	<p>PAD-VP-140*</p> 
<p>Sleeves in Gr. 5 titanium for P.A.D. abutments, rotating These are intended for immediate and definitive prostheses or for any necessary relining of a previous prosthesis for use as a temporary one Fixation screw included (code PAD-VP-140), and also available as a spare, to be tightened with a torque of 20–25 Ncm</p>	<p>PAD-CT</p> 
<p>Sleeves in Gr. 5 titanium for P.A.D. abutments, with hexagon, non-rotating. These are intended for immediate and definitive prostheses or for any necessary relining of a previous prosthesis for use as a temporary one. Fixation screw included (code PAD-VP-140), and also available as a spare, to be tightened with a torque of 25–30 Ncm</p>	<p>PAD-CT-EX</p> 
<p>Castable cylinders in PMMA for the production of structures to be cemented to titanium sleeves Effective for prosthetization without residual stresses</p>	<p>PAD-CCEM</p> 

See technical characteristics of Gr. 5 titanium, PMMA and “gold alloy 1”, on pages 196, 198 and 200.

Recommended torque for prosthetic screws: 20-25 Ncm.

*For a longer lifespan of the prosthetic rehabilitation, it is advisable to replace the PAD-VP-140 screws every time the prosthesis needs to be removed and refitted.

Insertion of straight P.A.D. abutments

The following pages illustrate the insertion of straight and angled P.A.D. abutments. For purely explanatory purposes, the images show an upper arch, so as to illustrate the use of both straight and angled abutments. The same insertion procedures are applicable even if rehabilitation envisages the use of a greater number of implants.



Use the AVV-ABUT-DG abutment carrier supplied to transport straight P.A.D. abutments into the patient's mouth. The carrier engages the upper hexagon of the P.A.D. abutment, and it is therefore not necessary to fully insert it to obtain the correct retention.

Important warning

Straight P.A.D. abutments are supplied in non-sterile packs. Before being used clinically, titanium abutments only must be sterilized in an autoclave. The AVV-ABUT-DG carrier is made in POM, and can therefore not be sterilized in an autoclave. The carrier must therefore be cold-sterilized before being used to transport an abutment into the patient's mouth.

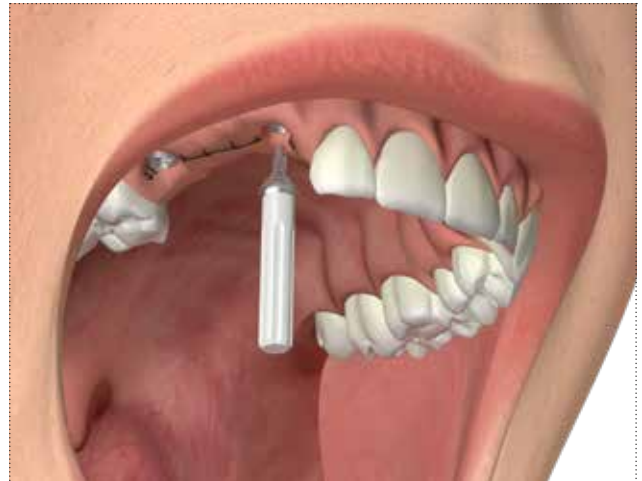

Insert the P.A.D. abutment into the implant connection, identify the correct engagement between the abutment thread and the socket thread, and screw in for a few turns. Remove the carrier from the P.A.D. abutment with a slight lever movement.



The screwing operation can be completed with the specific hexagonal key (code AVV2-ABUT), which must be purchased separately. This hexagonal key must be connected to the torque-control ratchet (CRI15).



If necessary, an extension can be used (BPM-15), to be fitted between the hexagonal key and the head of the ratchet.

Important warning

To guarantee the correct operation of instruments, periodic checks must be made to ensure that the retention of the rubber O-rings is adequate, replacing any that may be worn.



To stabilize the working axis of the ratchet and the instruments fitted to it, it is advisable to rest the index finger of the free hand on the ratchet wheel on the head of the ratchet.

Important warning

The maximum tightening torque for straight P.A.D. abutments, when directly screw retained is 25–30 Ncm. As it is difficult to control the insertion torque of prosthetic components manually, the procedure must always be completed using the torque-control ratchet.



Insertion of angled P.A.D. abutments

Use the HSM-20-DG driver to engage the connection screw (code PAD-VM-* depending on the implant connection): the special design of the instrument makes it possible to exercise a light grip inside the screw head, so that it can be transported and inserted in the hole in the side of the P.A.D. abutment.

Important warning

Angled P.A.D. abutments must be transported into the patient's mouth using the specific PAD-CAR transporter and a transfer screw, also made of titanium, to fix the abutment to the instrument. Before being used clinically, the components must be sterilized in an autoclave.



Position the angled P.A.D. abutment in the lower part of its specific carrier (code PAD-CAR), so that the screw hole of the abutment coincides with one of the two side holes in the carrier, depending on the orientation made necessary by the side of the mouth being operated on (**img. A**). Insert the transfer screw in the upper hole of the carrier (cod. PAD-VTRA-140) and tighten it onto the angled P.A.D. abutment (**img. B**).

Note: the transfer screw is not supplied together with the carrier. It can be ordered separately in a single pack. If there is not sufficient vertical space, the transfer screw for manual screwing PAD-VTRAL-140-MAN can be used as a carrier, without PAD-CAR, screwing it directly into the prosthetic hole (**img. C**).

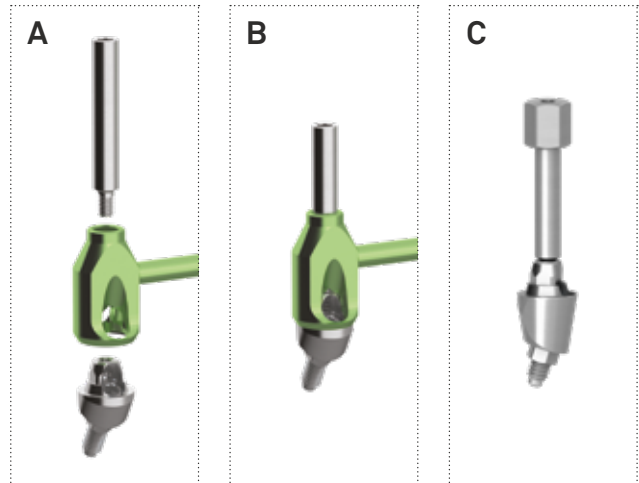

Position the transfer screw/carrier/angled P.A.D. assembly on the implant connection.



Keeping the abutment in place with the carrier, screw the connection screw fully.



Use the same driver of the HSM series to unscrew the transfer screw, and then extract the carrier.



Check for correct manual tightening torque again fitting a screwdriver of the HSM series into the ratchet (cod. CRI5).

Important warning

The maximum tightening torque for angled P.A.D. abutments, fixed with through screw, is 20–25 Ncm.

As it is difficult to control the insertion torque of prosthetic components manually, the procedure should always be completed using the torque-control ratchet. It is advisable to keep the ratchet in a perpendicular position during screwing operations, keeping the index finger of the free hand on the ratchet wheel to prevent swaying movements that could damage instruments and compromise the correct positioning of the abutments.



Impression on P.A.D. abutments with POM caps

After inserting the P.A.D. abutments in the implant connections, insert the POM caps with a slight pressure for the closed tray technique. No screws are used, because these caps directly grip the cone of the abutment. They are particularly indicated for cases of slight disparallelism of emergence platforms. See page 199 for the technical characteristics of POM.



If necessary, reduce the caps to fit the patient's vertical dimension removing one of the two ritentive tabs.

Inject a precision impression material (i.e. SKY IMPLANT LIGHT, code SKY14) only around the POM caps and fill the impression tray with a more consistant material (i.e. SKY IMPLANT ONEMIX-ED, code SKY08) over the entire arch.



Position the closed impression tray *in situ*, attempting to avoid lateral movements that may cause them to move accidentally. Wait for the hardening times as indicated by the instructions and lift the tray vertically.

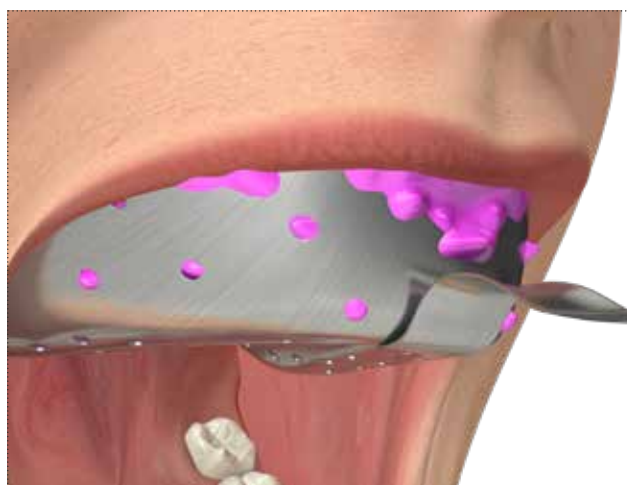

If the abutments are not to be immediately loaded and must be protected while they remain in the oral cavity, they can be covered with the specific PAD-CG titanium protection cap (**img. A**), or with the PAD-CGP caps in PEEK (**img. B**), which are smaller and can therefore be more easily hidden by a temporary prosthesis. These caps must be fitted onto the abutments using the screws provided. The recommended torque for tightening protection caps screws is 8–10 Ncm.

Important warning

Both types of protection cap are sold in non-sterile packs, and they must therefore be sterilized in an autoclave before clinical use, following the instructions given on page 208.



Position the PAD-ANA analogs in the impression tray, engaging them in the POM rotating caps.



Develop the model as usual.



Impression on P.A.D. abutments with Pick-up transfers

After inserting the P.A.D. abutments into the implant connections, screw the Pick-up transfers with the supplied long screw PAD-VTRAL-140, suitable for taking the impression with an individual open tray.

If desired, fix the transfers together with wire and resin or composite, and wait for polymerization to be completed, as indicated by the manufacturer.

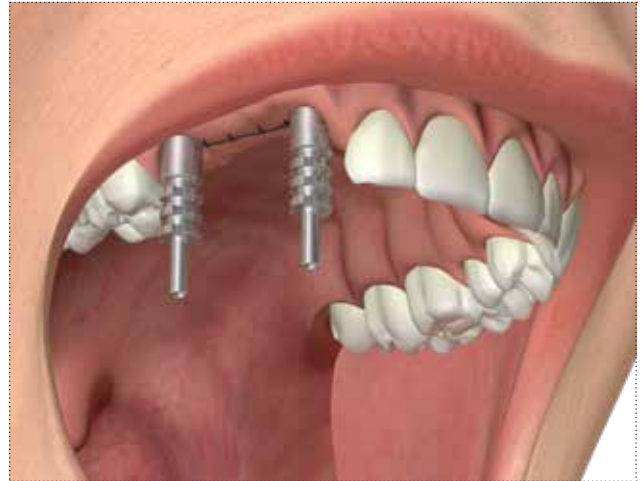

Inject a precision impression material (i.e. SKY IMPLANT LIGHT, code SKY14) only around the Pick-up transfers and fill the impression tray with a more consistent material (i.e. SKY IMPLANT ONEMIX-ED, code SKY08) over the entire arch.

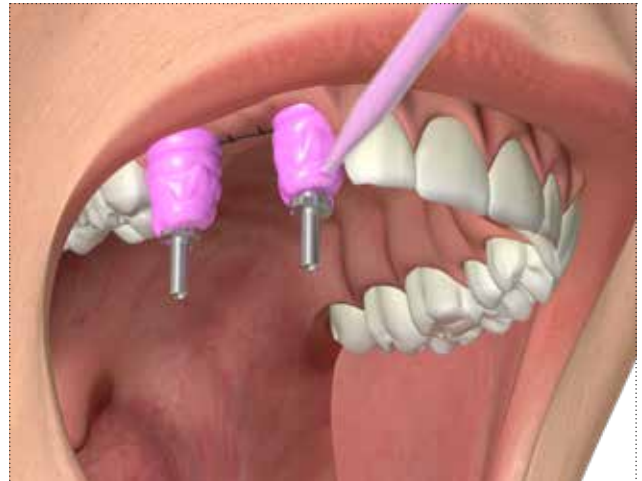

Position the tray *in situ*. The screw will emerge from the respective hole in the tray. Wait for the hardening times as indicated by the instructions, then unscrew the transfer screws and lift the tray vertically.

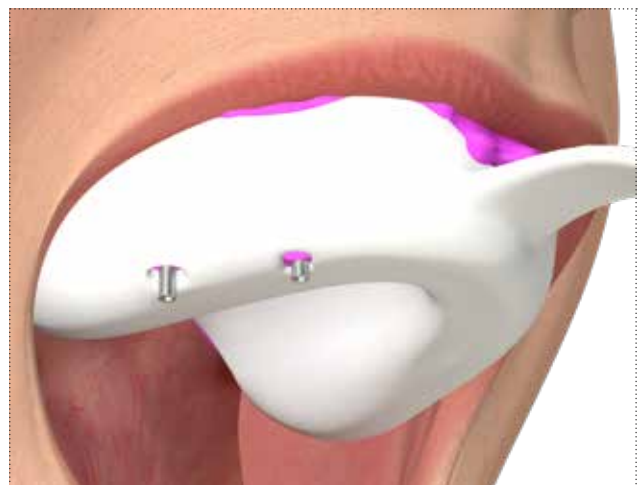

If the abutments are not to be immediately loaded and must be protected while they remain in the oral cavity, they can be covered with the specific PAD-CG titanium protection cap (**img. A**), or with the PAD-CGP caps in PEEK (**img. B**), which are smaller and can therefore be more easily hidden by a temporary prosthesis. These caps must be fitted onto the abutments using the screws provided. The recommended torque for tightening protection caps screws is 8–10 Ncm.

Important warning

Both types of protection cap are sold in non-sterile packs, and they must therefore be sterilized in an autoclave before clinical use, following the instructions given on page 208.



Screw the PAD-ANA laboratory analogs to the transfers with the screw PAD-VTRAL-140, replaced in the holes left by it in the impression material.



Develop the model as usual.



Immediate loading: luting technique

Screw on each P.A.D. analog a titanium sleeve with the specific supplied screw (cod. PAD-VP-140) on the precision model.

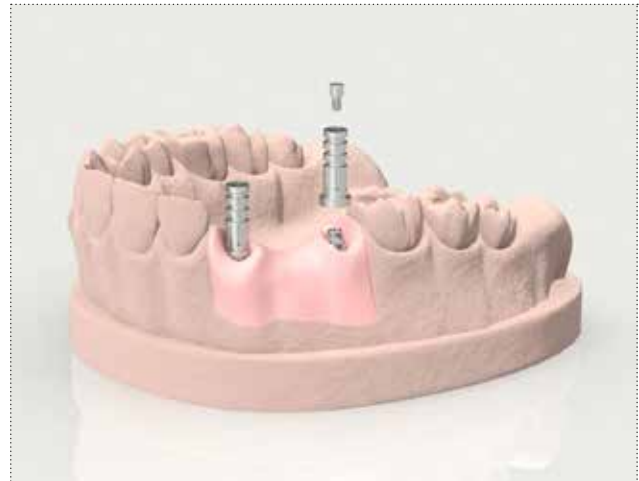

Insert on each titanium sleeve a castable cylinder in PMMA (cod. PAD-CCEM).

Reduce the titanium sleeves and the castable cylinders to a size compatible with the patient's vertical dimension with an abrasive disk.



Model a resin truss that incorporates the castable sleeves. Remove the structure from the model and proceed with casting, while the titanium sleeves remain tightened onto the P.A.D. abutments.



Ceramize the bridge as usual. Test the structure first on the model and then in the patient's mouth, checking for its complete passivity.

In the laboratory insert the resin cement between the truss and the titanium sleeves.

Note: take great care to correctly position the titanium sleeves in the patient's mouth, following the order of the model, so as to avoid creating discomfort and functional difficulties.



Screw the ceramic bridge that incorporates the sleeves in titanium to the P.A.D. abutments in the patient's mouth with the supplied screws (cod. PAD-VM-*) with a torque of 20-25 Ncm. Check the occlusal relationships and verify the absence of tensions. Preserve the screw heads and close the screw holes with a removable material, such as a composite or a resin.



Deferred loading: casting technique

Remove the temporary prosthesis and take the definitive impression on the P.A.D. abutments with Pick-up transfers and individual tray following the same procedures of the previous pages and develop the model as usual. Reposition the temporary prosthesis in the patient's mouth.



Screw the castable sleeves in PMMA to the abutments. Care must be taken during laboratory phases, before casting, to avoid tightening totally castable sleeves onto models with a torque greater than 8–10 Ncm, because polymers are weaker than metal.

Important warning

For the laboratory phases, always use spare prosthetic screws, available in single packs with code PAD-VP-140. Use new screws for final tightening in the patient's mouth.

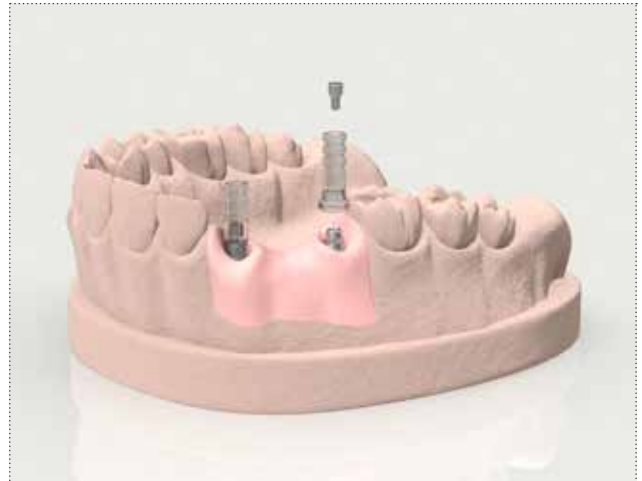

Reduce the castable sleeves if necessary to a size compatible with the patient's vertical dimension with an abrasive disk.



Model a resin truss that incorporates the castable sleeves.



Cast the structure as usual.
Test the structure first on the model and then in the patient's mouth, checking for its complete passivity.

Important warning

If the structure is not completely passive, even though the routine checking procedure has been followed before casting, correct it using the normal techniques.

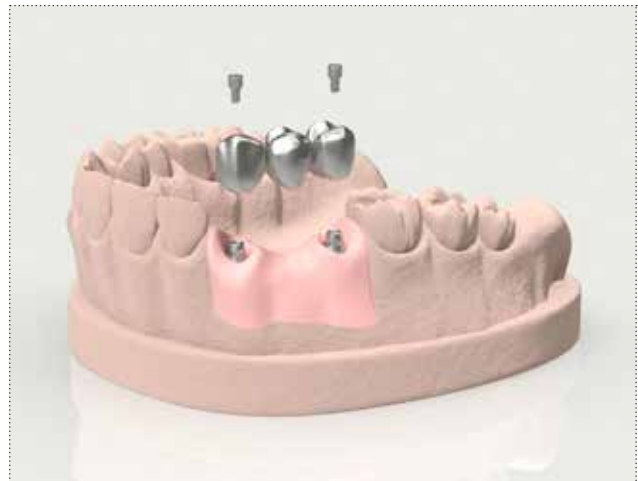

Ceramize the final prosthesis as usual and screw it on the P.A.D. abutments in the patient's mouth. Preserve the screw heads and close the screw holes with a removable material, such as a composite or a resin.
The recommended torque is 20-25 Ncm.



Temporary and definitive rehabilitation with vertical technique

The principles of the vertical technique have been transferred to implantoprosthesis thanks to the fabrication of different prosthetic components, such as the healing abutments, the aesthetic healing abutments, the temporary posts in REEF resin and the vertical technique posts.

The vertical technique posts are available in two diameters for Premium Kohno implants and one diameter for Shelta implants: the decision to simplify the range has been also supported by the excellent clinical results of the Platform Switching protocols reported in the literature.

For the soft tissues conditioning during the healing phase healing abutments (**img. A**), aesthetic healing abutments and temporary posts in REEF resin* are available, whose particular nanostoichiometric conformation allows high resistance to attack by bacteria and to plaque adhesion, facilitating the healing phase. The standard healing abutments present a laser marking on the upper surface which reports the connection diameter, the flare of the healing abutment and the transgingival height.

Preparable posts for the definitive rehabilitation are available (**img. B**) on which it is possible to take the impression using a cap, the same for all the systems and diameters (**img. C**). The head of the post mates at the end with the cap, allowing maximum fit and repositioning of the posts in the impression for the development of the model.

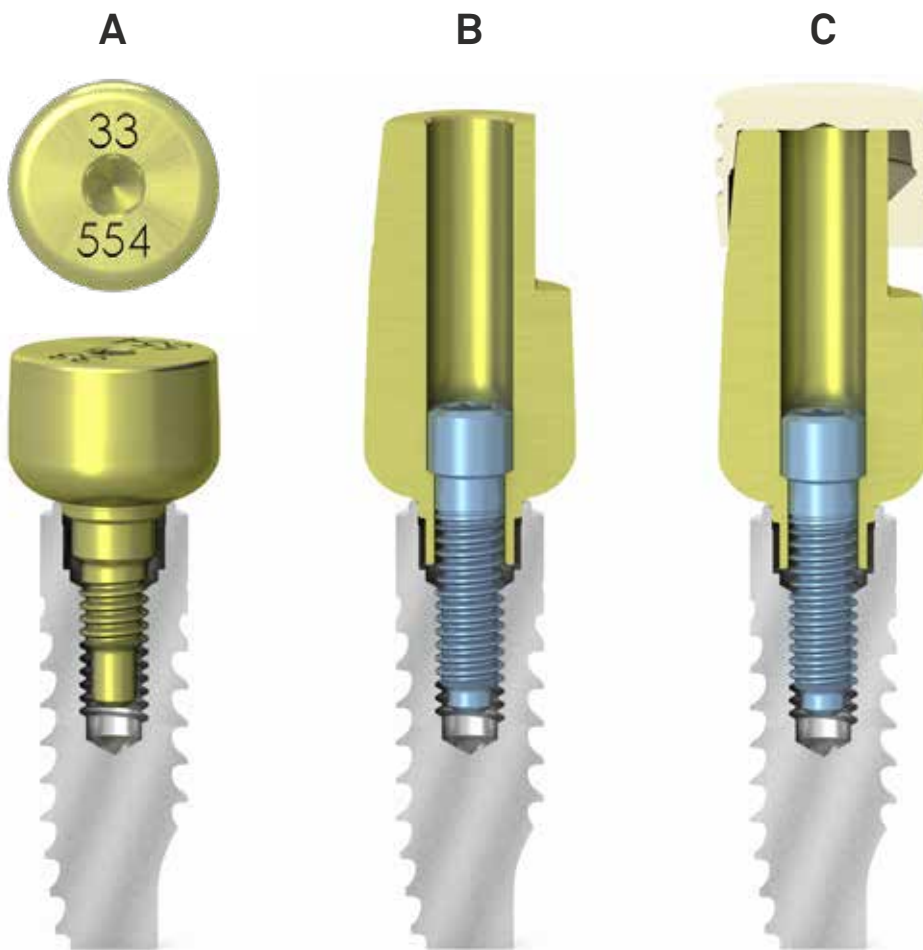

According to the principles of the vertical technique (Biologically Oriented Preparation Technique) a simplified line has been developed that allows you to have only two posts for Premium and Kohno platforms and only one post for all diameters of the Shelta line. This is possible thanks to the particular design of the connection, different from the classic connection, which allows it to rest safely on the platform of the centring collar.

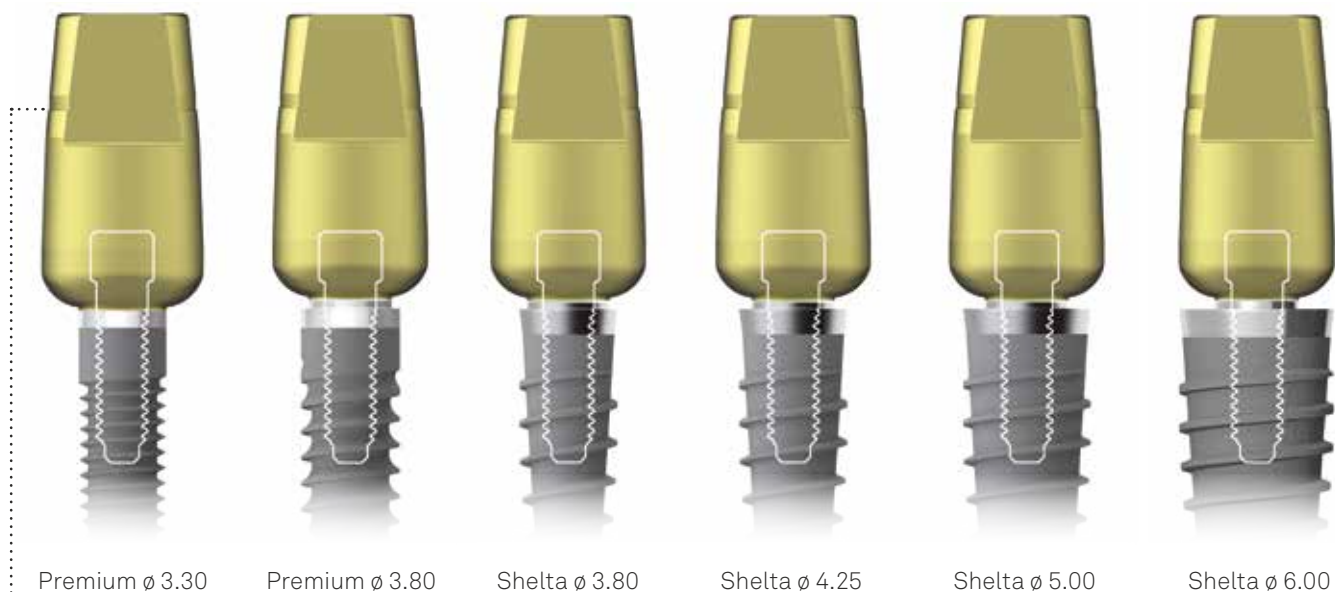



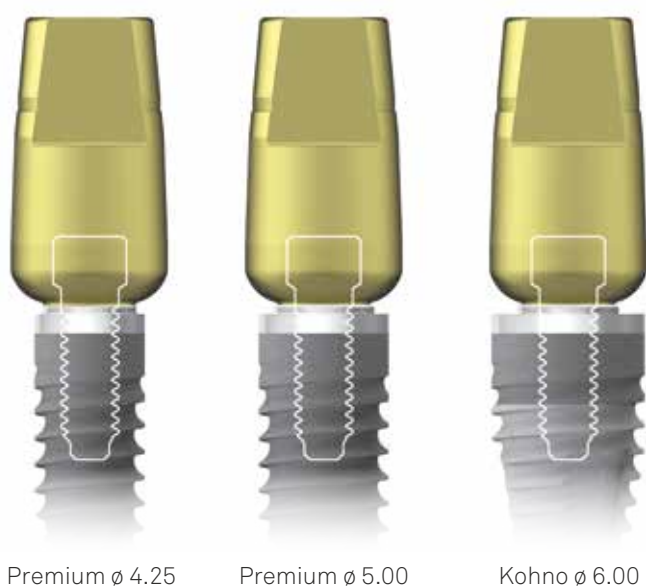





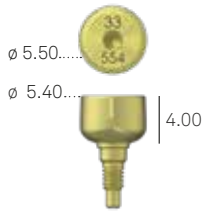
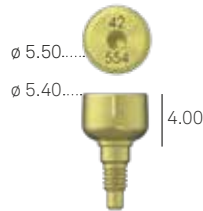

The same vertical technique millable post **A-MEFL-330** with a 2.30 mm hexagon is used on Premium Kohno implants with ø 3.30 and 3.80 mm and on all the diameters of Shelta implants, that is 3.80, 4.25, 5.00 and 6.00 mm.









The same vertical technique millable post **A-MEFL-425** with a 2.50 mm hexagon is used on Premium Kohno implants with ø 4.25 and 5.00 mm and for the Kohno implant ø 6.00 mm.

Vertical technique posts for Premium Kohno implants

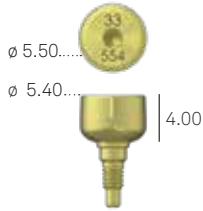
prosthetic component ø	3.30	3.80	4.25	5.00
for implants	Premium 3.30 - 3.80 Kohno 3.80	Premium 3.80 Kohno 3.80	Premium 4.25 Kohno 4.25	Premium 5.00 Kohno 5.00 - 6.00
Vertical technique healing abutments	A-TMG-MEFL-330 	Use A-TMG-MEFL-330	A-TMG-MEFL-425 	Use A-TMG-MEFL-425
Temporary Vertical technique posts in REEF resin Engaging Fixation screw included	A-PPF-330-EX 	Use A-PPF-330-EX	A-PPF-425-EX 	Use A-PPF-425-EX
Temporary Vertical technique posts in REEF resin Non engaging Fixation screw included	A-PPF-330 	Use A-PPF-330	A-PPF-425 	Use A-PPF-425
Vertical technique preparable posts in titanium Fixation screw included	A-MEFL-330 	Use A-MEFL-330	A-MEFL-425 	Use A-MEFL-425
Pack of 5 pieces Cap for vertical technique taking impressions	CAP-MEFL-5 	Use CAP-MEFL-5	Use CAP-MEFL-5	Use CAP-MEFL-5
Single pack Pack of 10 pieces Fixation screw Supplied with the posts, it can also be ordered separately as a spare	VM2-180 VM2-180-10 	Use VM2-180	VM2-200 VM2-200-10 	Use VM2-200

Recommended torque for vertical technique healing abutments and REEF resin posts: 8-10 Ncm. Recommended torque for titanium vertical technique posts: 20-25 Ncm. *Since the shape of the aesthetic healing abutment is suitable for use in distal sectors, it is not available in diameter 3.30

Vertical technique posts for Shelta implants

prosthetic component \emptyset	3.30	3.80	4.25	5.00
for implants	Shelta 3.80	Shelta 3.80 - 4.25 5.00 - 6.00	Shelta 4.25 - 5.00 - 6.00	Shelta 5.00 - 6.00
Vertical technique healing abutments	A-TMG-MEFL-330 	Use A-TMG-MEFL-330	Use A-TMG-MEFL-330	Use A-TMG-MEFL-330
Temporary Vertical technique posts in REEF resin Engaging Fixation screw included	A-PPF-330-EX 	Use A-PPF-330-EX	Use A-PPF-330-EX	Use A-PPF-330-EX
Temporary Vertical technique posts in REEF resin Non engaging Fixation screw included	A-PPF-330 	Use A-PPF-330	Use A-PPF-330	Use A-PPF-330
Vertical technique preparable posts in titanium Fixation screw included	A-MEFL-330 	Use A-MEFL-330	Use A-MEFL-330	Use A-MEFL-330
Pack of 5 pieces Cap for vertical technique impressions	CAP-MEFL-5 	Use CAP-MEFL-5	Use CAP-MEFL-5	Use CAP-MEFL-5
Single pack Pack of 10 pieces Fixation screw Supplied with the posts, it can also be ordered separately as a spare	VM2-180 VM2-180-10 	Use VM2-180	Use VM2-180	Use VM2-180

Recommended torque for vertical technique healing abutments and REEF resin posts: 8-10 Ncm. Recommended torque for titanium vertical technique posts: 20-25 Ncm. *Since the shape of the aesthetic healing abutment is suitable for use in distal sectors, it is not available in diameter 3.30. See technical characteristics of Gr. 5 titanium, REEF resin and PEEK on pages 196 and 197.

Tissues conditioning with healing abutments

When inserting the implants, if the treatment plan allows it, it is opportune to allow the tissues to take shape around anatomically studied morphologies to maximise the amount of keratinised tissue adhering to the prosthesis.

It is possible to condition the soft tissues around the implants in the post-operative stage with vertical technique healing abutments that redefine the emergence of the vertical technique posts and thus keep the gum in a favourable position for them to adapt to the final post.



The vertical technique healing abutments are screw retained onto the implant with a screwdriver of the HSM series. The recommended torque is 8-10 Ncm.



The vertical technique healing abutments are available with height of 4.00 mm. The shape of the profile, which is convex, makes them adaptable to all the different thicknesses of soft tissues. The subsequent centric reduction of the post will allow the mucosae to also occupy the additional space at their disposal, avoiding phenomena of excessive compression or tissues ischemia.

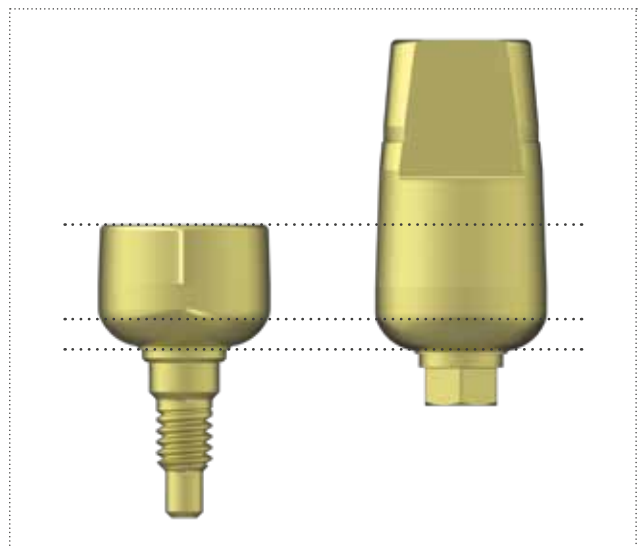

Temporary single screw retained rehabilitation – direct method

For the frontal sectors, where the spaces are limited but the need for an aesthetic temporary post is even greater, vertical technique temporary posts in REEF resin are available with a reduced size, on which a moulded prosthesis made in the laboratory can be easily fixed chair-side. The advantages are the bond of acrylic on acrylic and the absence of dyschromia due to metal cylinders.



Screw the temporary vertical technique post in REEF resin onto the implant and leaving it initially at the original length.

The recommended torque is 8-10 Ncm.

Insert on the post a pre-made pierced crown made in the laboratory so as to allow it to slide easily on the cylinder body in resin.



Fix with resin the pre-made crown to the vertical technique temporary post and wait for polymerization as indicated by the instructions.



Once polymerization is completed proceed to the filling with resin of the whole space between the pre-made crown and the vertical technique temporary post.



Finish the temporary prosthesis both in its occlusal portion, eliminating the excess of the temporary post, and in the apical portion, according to the shapes of the emergence profiles.



Screw the temporary prosthesis with the supplied screw and a screwdriver of the HSM series. The recommended torque must not exceed 8-10 Ncm.

The temporary crown will help not only to ensure an adequate quality of life for the patient while waiting for the definitive prosthesis, but also the correct conformation of the soft tissues that will later receive the definitive prosthesis with excellent aesthetic results.



Temporary single screw retained rehabilitation – indirect method

The fabrication of the temporary prosthesis can take also place in the laboratory, on the model.



Insert the engaging vertical technique temporary post in REEF resin on the model.

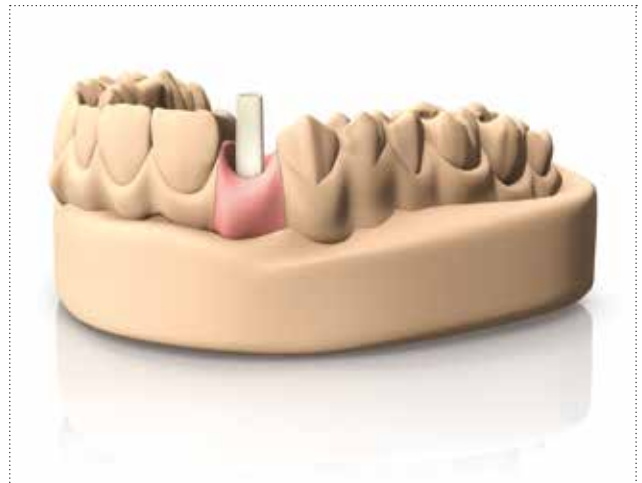

Reduce the post to a size compatible with the patient's vertical dimension with an abrasive disk.



Produce the screw retained crown according to the traditional procedures.



Riduce the finished element, to prevent it causing occlusal interference when it is inserted in the patient's mouth.

Important warning

The recommended tightening torque is 8-10 Ncm. It is recommended to use new screws for tightening in the mouth.

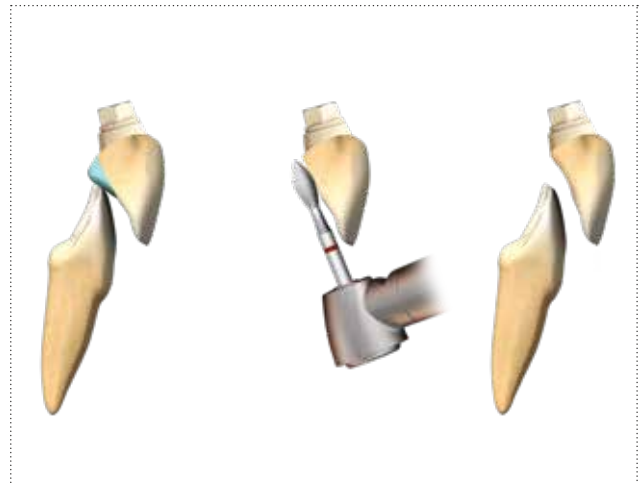

Temporary multiple screw retained rehabilitation – direct method

For bridges in the frontal sectors, where the spaces are limited but the need for an aesthetic temporary post is even greater, vertical technique temporary posts in REEF resin are available with a reduced size, on which a moulded prosthesis made in the laboratory can be easily fixed chair-side. The advantages are the bond of acrylic on acrylic and the absence of dyschromia due to metal cylinders.



Screw the temporary vertical technique posts in REEF resin onto the implants.
The recommended torque is 8-10 Ncm.



Insert on the posts a pre-made bridge made in the laboratory and pierced so as to allow it to slide easily on the cylinder body in resin. In the case of undercuts or difficulties in insertion, it is recommended to widen the access hole, possibly avoiding intervention on the vertical dimension of the posts.



Fix with resin the pre-made bridge to the vertical technique temporary posts and wait for polymerization as indicated by the instructions.



Remove the pre-made bridge including the vertical technique temporary posts and proceed to fill with resin the whole space between the pre-made bridge and the posts.



Finish the temporary prosthesis both in its occlusal portion, eliminating the excess of the temporary post, and in the apical portion, according to the shapes of the emergence profiles.



Screw the temporary prosthesis with the supplied screw and a screwdriver of the HSM series. The recommended torque must not exceed 8-10 Ncm.



The temporary bridge will help not only to ensure an adequate quality of life for the patient while waiting for the definitive prosthesis, but also the correct conformation of the soft tissues that will later receive the definitive prosthesis with excellent aesthetic results.



Temporary multiple screw retained rehabilitation – indirect method

The fabrication of the temporary prosthesis can take also place in the laboratory, on the model.



Insert the vertical technique temporary posts in REEF resin on the model.

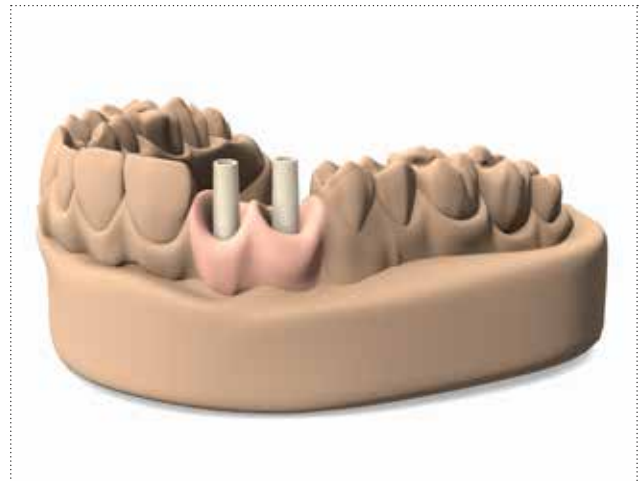

Reduce the posts to a size compatible with the patient's vertical dimension with an abrasive disk.



Produce the crowns or the bridge according to the traditional procedures.



Riduce the finished elements, to prevent them causing occlusal interference when they are inserted in the patient's mouth.

Important warning

The recommended tightening torque is 8-10 Ncm. It is recommended to use new screws for tightening in the mouth.

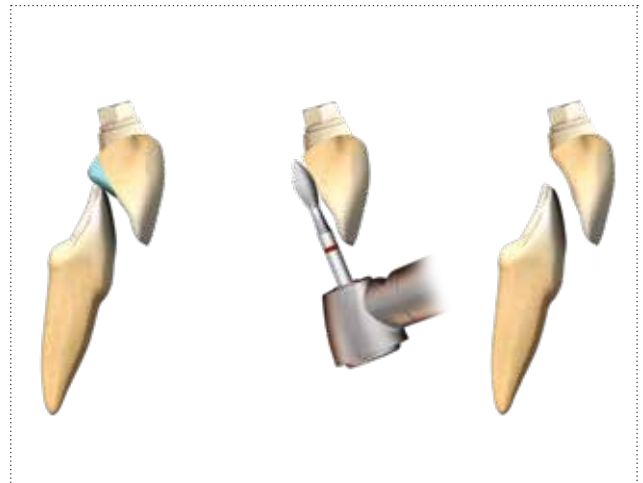

Impression phase on vertical technique post

Remove the vertical technique healing abutments and screw the vertical technique preparable posts in the patient's mouth, using a screwdriver of the HSM series.

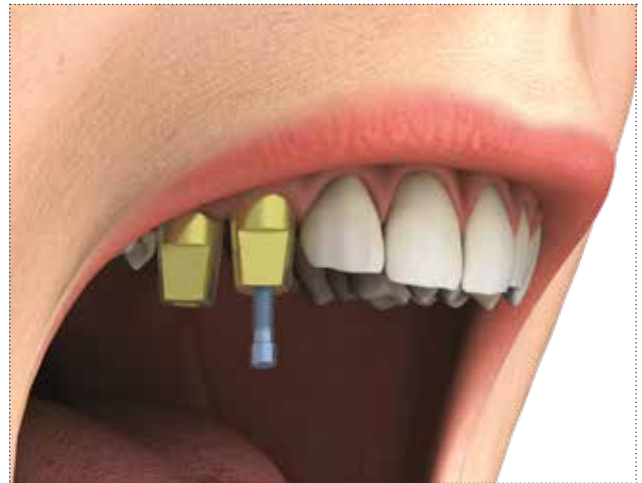

Position the caps CAP-MEFL-5 for taking the impression on the top of vertical technique posts with a light pressure, until feeling the end stop. The caps mate accurately, so the impression is very precise and prevent silicone getting into the hole for the passing screw, therefore it is not necessary to use wax to close the passage.



Inject an impression material around the vertical technique posts.



Fill the impression tray with a more consistent impression material and then position it *in situ*: check that the entire vertical section of the vertical technique preparable posts is contained in the impression material.

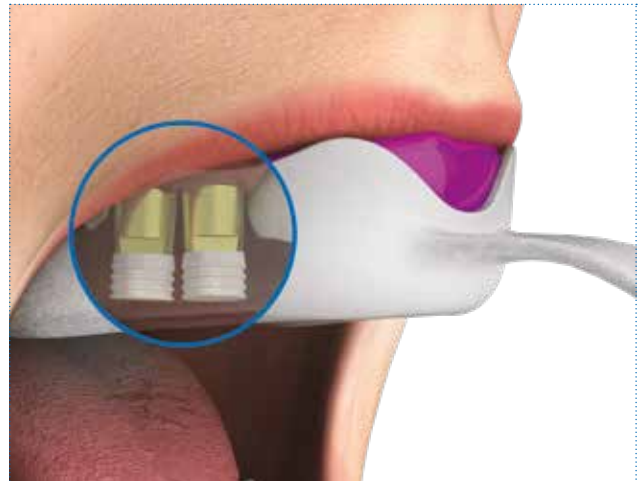

Wait for the hardening times as indicated by the instructions. Remove the tray: the vertical technique caps will remain in the impression material.



Reposition the vertical technique posts tightened to the implant analogs inside the caps, guiding them along the repositioning face as far as the end stop. The repositioning faces and the exact end stop on the top of the posts will allow all the information collected by the impression to be reported correctly to the laboratory. Develop the model as usual.



Tighten the vertical technique posts on the model with the specific screw. Reduce them to a size compatible with the patient's vertical dimension with an abrasive disk.

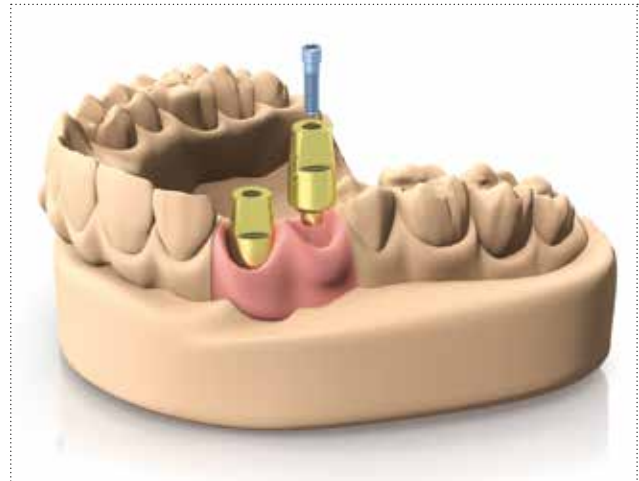

Proceed to modelling and finalization of the prosthetic restoration, whether it is a crown or a bridge.

Important warning

It is recommended to use a new screw for fixing the prosthesis in the patient's mouth. The recommended tightening torque is 25-30 Ncm.



Temporary and definitive rehabilitation with Conoweld conometric technique*

The Gr. 5 titanium posts that form part of the Conoweld prosthetic range have been specifically designed to rest securely on the COLLEX collar.

This makes it possible to have only two posts for the Premium and Kohno platforms: one with a 2.30 mm hexagon for platforms with implant diameters of 3.30 mm and 3.80 mm, and one with a 2.50 mm hexagon for platforms with implant diameters of 4.25 mm, 5.00 mm and 6.00 mm, without any difference between straight and SP implant emergences.

The Shelta implants, which share the same connection with a 2.30 mm hexagon, use the same Conoweld post for all the diameter of the system.

The same Conoweld straight and angled posts with a 2.30 mm hexagon are used on Premium Kohno implants with \varnothing 3.30 and 3.80 mm and on all diameters of Shelta implants, that is 3.80, 4.25, 5.00 and 6.00 mm.



Premium \varnothing 3.30 Premium \varnothing 3.80
Kohno \varnothing 3.80 Shelta \varnothing 3.80 Shelta \varnothing 4.25 Shelta \varnothing 5.00 Shelta \varnothing 6.00

The same Conoweld straight and angled posts with a 2.50 mm hexagon are used on Premium Kohno implants with \varnothing 4.25 and 5.00 mm and for the Kohno implant \varnothing 6.00 mm.



Premium \varnothing 4.25 Premium \varnothing 5.00 Kohno \varnothing 6.00
Kohno \varnothing 4.25 Kohno \varnothing 5.00

The Conoweld technique utilizes the advantages of two protocols already widely established in oral implantoprosthesis: intraoral welding and conometric retention



*Conoweld prosthetic components may not be released for sale in all markets. For the USA consult the manual MP-IMP-CONICO-USA.

The Conoweld range includes three different caps, which are universal in relation to the diameters of the posts and the implant platforms: this is due to the fact that conometric retention is in the most coronal portion of the post, which always has the same dimensions.

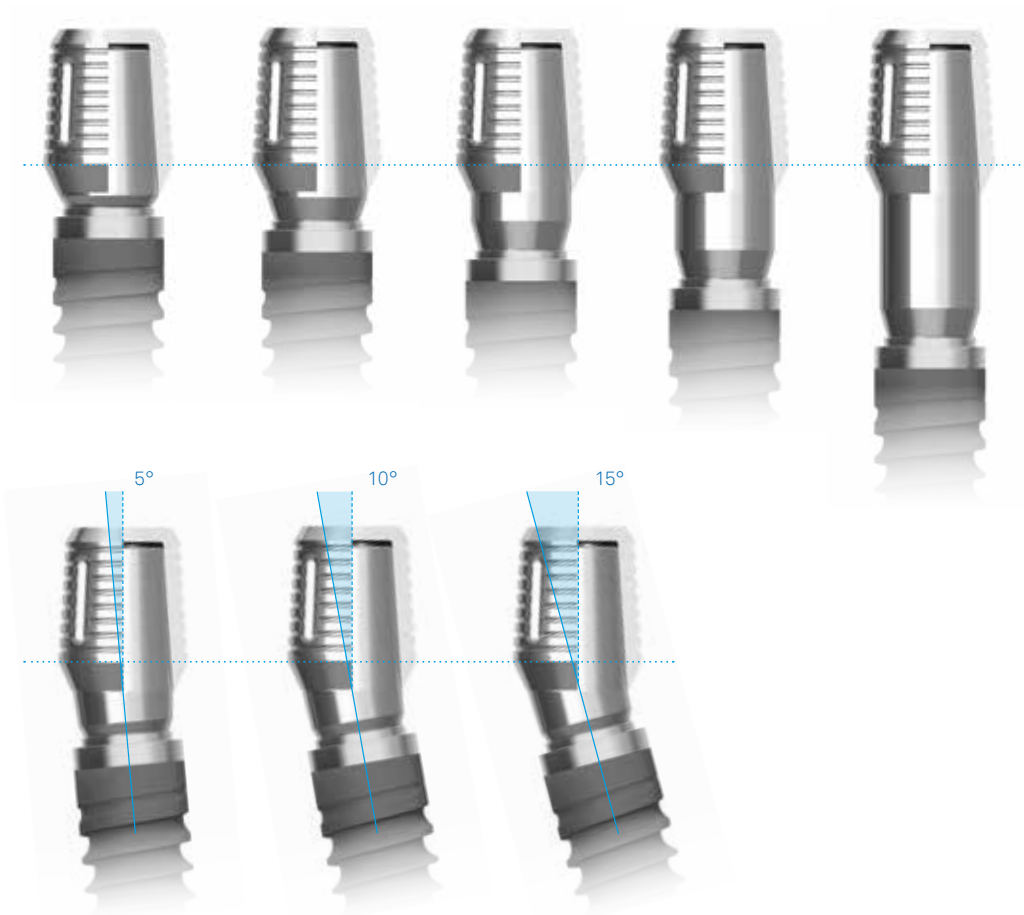









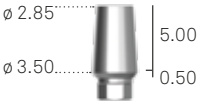
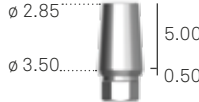
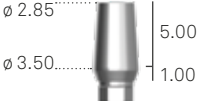
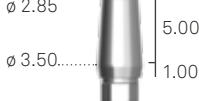
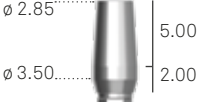



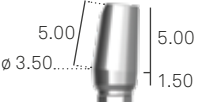

The two titanium caps differ in thickness: the cap designed for the construction of a welded structure intraorally for the temporary stage is thicker in order to withstand the welding with the titanium bars, without bonding with the underlying post, while the cap designed to anchor the final prosthesis glued on is thinner, in order to reduce the impact on the anatomical morphology of the prosthesis; it should not, therefore, be used for the welding.

A cap in PMMA is also available, which allows a precise impression to be taken even when working without an intraoral welding machine and which can be used for modelling and casting a structure entirely in cobalt chrome or other alloys, when the decision has been taken not to use gluing techniques for assembly.









Conoweld posts for Premium Kohno and Shelta implants

prosthetic component hexagon	2.30	2.50
for implants	Premium 3.30 - 3.80 Kohno 3.80 Shelta 3.80 - 4.25 - 5.00 - 6.00	Premium 4.25 - 5.00 Kohno 4.25 - 5.00 - 6.00
Conoweld post in Gr. 5 titanium Straight Transgingival H. 0.50 mm Fixation screw included	A-MD-TS-EX230-05 	A-MD-TS-EX250-05 
Conoweld post in Gr. 5 titanium Straight Transgingival H. 1 mm Fixation screw included	A-MD-TS-EX230-1 	A-MD-TS-EX250-1 
Conoweld post in Gr. 5 titanium Straight Transgingival H. 2 mm Fixation screw included	A-MD-TS-EX230-2 	A-MD-TS-EX250-2 
Conoweld post in Gr. 5 titanium Straight Transgingival H. 3 mm Fixation screw included	A-MD-TS-EX230-3 	A-MD-TS-EX250-3 
Conoweld post in Gr. 5 titanium Straight Transgingival H. 5 mm Fixation screw included	A-MD-TS-EX230-5 	A-MD-TS-EX250-5 
Conoweld post in Gr. 5 titanium Angled at 5° Fixation screw included	A-MA05-TS-EX230 	A-MA05-TS-EX250 
Conoweld post in Gr. 5 titanium Angled at 10° Fixation screw included	A-MA10-TS-EX230 	A-MA10-TS-EX250 
Conoweld post in Gr. 5 titanium Angled at 15° Fixation screw included	A-MA15-TS-EX230 	A-MA15-TS-EX250 
Single pack Pack of 10 pieces	VM2-180 VM2-180-10	VM2-200 VM2-200-10
Fixation screw for Conoweld posts Supplied with the posts and also available separately as a spare	 M 1.8.....	 M 2.0.....

Recommended torque for Conoweld posts: 20-25 Ncm.

See technical characteristics of Gr. 5 titanium on page 196.

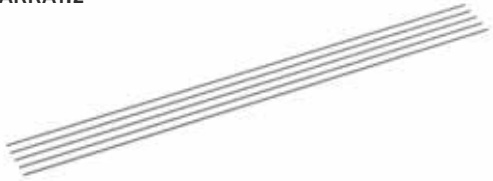
Components for Conoweld technique

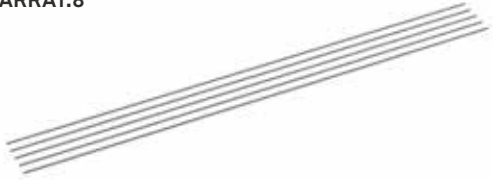
description	code
Temporary cap for intraoral welding	CAP-TS-PRO  5.70
Final cap for luting	CAP-TS-DEF  5.70
Cap for impression taking	CAP-TS-IMP  5.70
Analog of the Conoweld post for intraoral welding	ANA-TS  17.00
Package of 5 pieces Bar in Gr. 2 titanium, L. 150 mm, \varnothing 1.20 mm	DW-BARRA1.2 
Package of 5 pieces Bar in Gr. 2 titanium, L. 150 mm, \varnothing 1.50 mm	DW-BARRA1.5 
Package of 5 pieces Bar in Gr. 2 titanium, L. 150 mm, \varnothing 1.80 mm	DW-BARRA1.8 

Temporary multiple rehabilitation with intraoral welding on Conoweld caps

Position the Conoweld posts on the implants, choosing the transgingival height that is the most suitable and the angle that is most appropriate in the case of disparallel implants. Tighten with the fixation supplied screws using one of the HSM drivers.

The torque must not exceed 20-25 Ncm.



Position the temporary Conoweld caps (cod. CAP-TS-PRO) on the abutments, gently applying manual pressure. Take a Gr. 2 titanium bar for intraoral welding of the most suitable thickness and curve it manually in line with the arch to be rehabilitated.

Note: avoid cutting the bar to measure at the outset, as the excess segment makes removal and repositioning easier to handle until the welding of the caps is complete.



Line up the segment of the bar with one of the two caps and carry out welding with the special intraoral welding machine, following the manufacturer's instructions.

Important warning

To set the operating parameters for the welding machine and for the relevant information and warnings, read and follow the instructions in the manual issued by the manufacturer of the equipment.

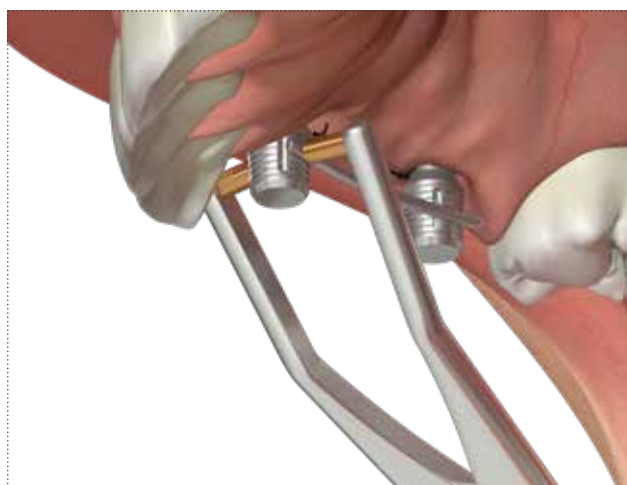

In order to establish that the procedure has been carried out correctly, it is advisable after each welding, and before the next, to remove the bar and caps that have been fixed up until that point. This helps to establish that the wall of the cap and the underlying post have not bonded and to be sure that a passive structure is being built.

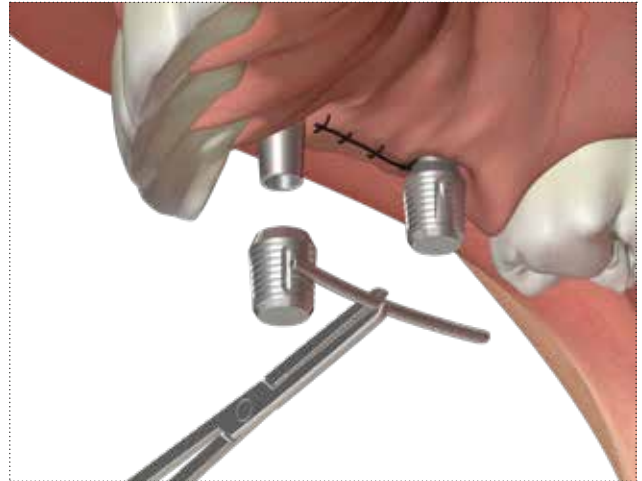

Having positioned the first cap back on its post, guide the bar round and, if necessary, remodel it, in order to weld it to the next cap along.

Note: in order to further increase the passive nature of the structure and eliminate any residual stress, welding is advisable at a halfway point along each segment of free titanium along the bar.



Remove the structure made up of the bar and the first two caps welded to it in order to establish that that the wall of this second cap and the underlying post have not bonded and to establish that the structure is passive.



Direct protocol: production of an immediate temporary prosthesis

The temporary prosthesis for immediate loading can be produced both in the laboratory or chair-side, relining a pre-made prosthesis. The resin will incorporate the welded structure, making easier the cleaning operations of the patient.



Remove the structure composed of the bar and the two caps: check the space occupied from the structure in the pre-made prosthesis made in the laboratory.



Position the structure composed of the bar and the two caps in the patient's mouth and proceed to a direct relining using the pre-made prosthesis filled with resin, removing the excess material.



Remove the relined temporary prosthesis, finish and polish it.
Then, proceed to the immediate positioning on the Conoweld posts: the interaction via conometry between the posts and the Conoweld caps will give the structure an excellent retention, which will allow the dentist to remove the temporary prosthesis at any time, but it will not permit the patient to remove it himself.



This particular feature of conometric rehabilitation ensures solid splinting throughout the entire osseointegration period, limiting the micromovements of the implants, even where the bone is only slightly mineralised.



Indirect protocol: impression on transfer Conoweld caps in PMMA

As an alternative, the impression can be taken directly on the welded structure or using the special Conoweld caps in PMMA (cod. CAP-TS-IMP), as illustrated. Insert the caps in PMMA on the Conoweld posts and gently applying manual pressure.

If desired, fix the caps between each other using resin and wire or composite.



Choose a tray of suitable dimensions, so that the vertical portion of the caps and the posts is contained inside the walls of the impression tray. Inject a precision impression material (i.e. SKY IMPLANT LIGHT, code SKY14) around the caps. Fill the impression tray with a more consistent impression material (i.e. SKY IMPLANT ONEMIX-ED, code SKY08) over the entire arch.



Then position the tray *in situ* and wait for the hardening times as indicated by the instructions.



Lift the tray vertically: the PMMA caps will remain incorporated in the impression material.

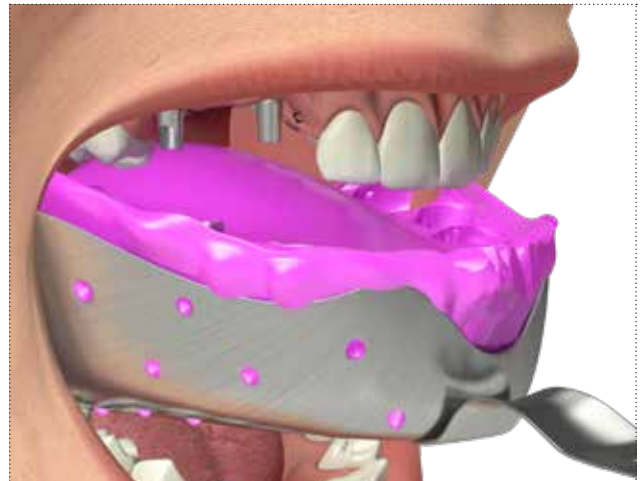

Place the Coloweld post analogs into the caps in the impression material and send the impression to the laboratory together with the intraorally welded structure. Cast the model as usual.

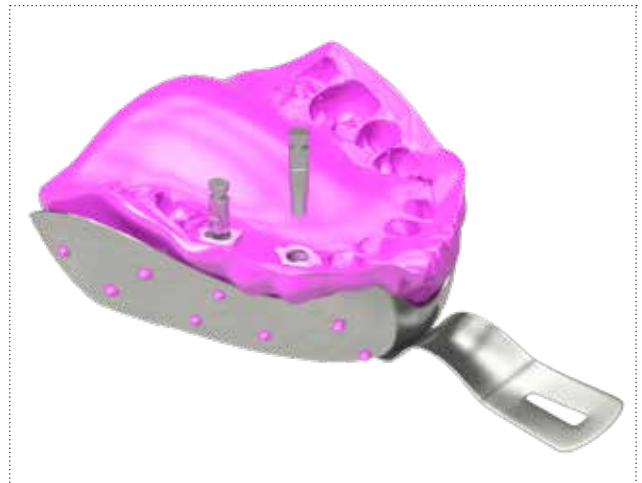

On the model create a support structure for the temporary prosthesis welded in the laboratory or obtained with the traditional techniques, exploiting the conometric components of the system. Check it on the model for its complete passivity, whether it has been realized intraorally or in the laboratory.

Produce a temporary prosthesis in resin as usual and send it again to the laboratory for the positioning in the patient's mouth.



Definitive multiple rehabilitation with conometric technique

Luting technique of a cast structure on titanium caps

Insert the final titanium caps (cod. CAP-TS-DEF) on the precision model on the posts applying a slight manual pressure.



Make a wax-up of the structure, interposing a lab spacer in order to passivate the final prosthesis and facilitate the successive luting of the caps. The caps will only be in direct contact with the structure on the flat occlusal surface, making a precise re-seat of the structure possible on the model in the laboratory as well as during the various intraoral tests.



Cast only the structure made of wax, leaving the Conoweld caps on the model.



Finish the base of the structure and proceed to ceramization.



Lute the ceramized structure on the caps: for this purpose it is useful to use a small layer of primer, such as ZPrime, before cementing with a cement such as Bis-Cem.



Position the ceramic bridge on the Conoweld posts: the interaction via conometry between the posts and the Conoweld caps will give the structure an excellent retention, which will allow the dentist to remove the temporary prosthesis at any time, but it will not permit the patient to remove it himself.

Important warning

To obtain the best results in terms of precision and passivity, it is advised that the caps be luted intraorally. Luting cannot be carried out before ceramic is applied, as the temperatures used in firing the ceramic are incompatible with all cement types.



Complete casting technique with castable caps

Insert the Conoweld PMMA caps (cod. CAP-TS-IMP) on the precision model onto the Conoweld analogs applying a slight manual pressure.



Reduce the castable caps to a size compatible with the patient's vertical dimension with an abrasive disk.



Fabricate a structure in wax or resin, that incorporates the Conoweld castable caps.



Cast the modelled structure with the castable Conoweld caps inside.



Finish the base of the structure and proceed to the ceramic coating.

Important warning

Structures produced by bonding the castable caps may require temporary cement in order to be fixed intraorally; given its own limitations, casting makes it difficult to achieve the same fit as with the standard caps for luting.



Position the bridge on the Conoweld posts; the interaction via conometry between the posts and the Conoweld caps will give the structure an excellent retention, which will not permit the patient to remove it himself.



Definitive rehabilitation with T-Connect

T-Connect supports are made of Gr. 5 titanium and present a conical body with grooves to facilitate the luting both of crowns and multiple structures made in the laboratory. The cementing cone of the T-Connect is available in the heights of 4 and 6 mm.

In the T-Connect range sleeves for wax-up are also available, respecting the volumes of the T-Connect: the entire height is 12 mm and helps to preserve the screw hole from accidental obstructions.



.....Castable sleeve for wax-up modelling

.....T-Connect in Gr. 5 titanium











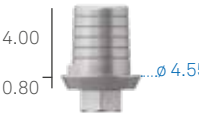
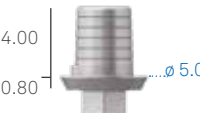

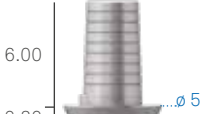

T-Connect supports make it possible to create integral crowns, posts and multiple structures using a luting technique and different materials, with all open CAD-CAM systems, including Echo by Sweden & Martina, without sacrificing the micrometric precision in coupling between platforms that can be obtained with conventional components. The Milling Center Echo by Sweden & Martina delivers the milled prosthesis, whether it is made of zirconia, lithium disilicate, cobalt chrome or other material, separated from the T-Connect support: the two parts can be luted together on the bench using an anaerobic cement.

The prosthesis, milled by Sweden & Martina, can be made of different materials, such as zirconia and lithium disilicate



The Gr. 5 titanium base permits to obtain a perfect coupling between the prosthesis and the implant

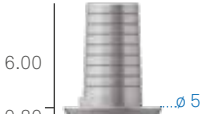
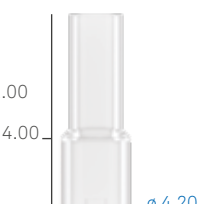
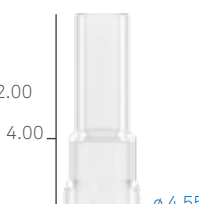
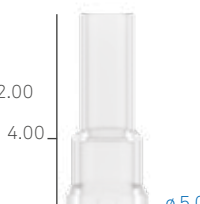
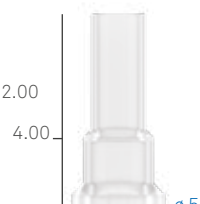
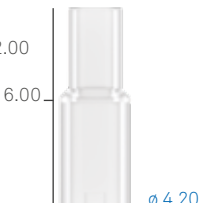
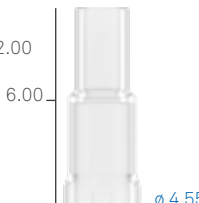
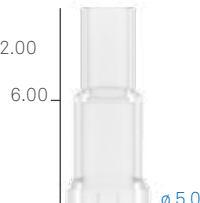
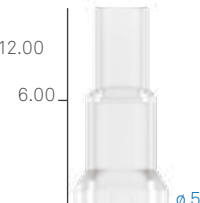









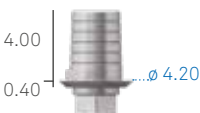







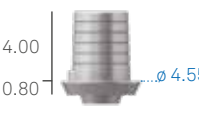





T-Connect for Premium Kohno implants

prosthetic component \emptyset	3.30	3.80	4.25	5.00
for implants	Premium 3.30 - 3.80 Kohno 3.80	Premium 3.80 Kohno 3.80	Premium 4.25 Kohno 4.25	Premium 5.00 Kohno 5.00 - 6.00
T-Connect Engaging Cone H. 4 mm Fixation screw included	A-BASTZR-S-330-4 	A-BASTZR-S-380-4 	A-BASTZR-S-425-4 	A-BASTZR-S-500-4 
T-Connect Engaging Cone H. 6 mm Fixation screw included	A-BASTZR-S-330-6 	A-BASTZR-S-380-6 	A-BASTZR-S-425-6 	A-BASTZR-S-500-6 
T-Connect Non engaging Cone H. 4 mm Fixation screw included	A-BASTZR-M-330-4 	A-BASTZR-M-380-4 	A-BASTZR-M-425-4 	A-BASTZR-M-500-4 
T-Connect Non engaging Cone H. 6 mm Fixation screw included	A-BASTZR-M-330-6 	A-BASTZR-M-380-6 	A-BASTZR-M-425-6 	A-BASTZR-M-500-6 
Sleeve for wax-up modelling on T-Connect supports with cone H. 4.00 mm	A-CCBAS-330-4 	A-CCBAS-380-4 	A-CCBAS-425-4 	A-CCBAS-500-4 
Sleeve for wax-up modelling on T-Connect supports with cone H. 6.00 mm	A-CCBAS-330-6 	A-CCBAS-380-6 	A-CCBAS-425-6 	A-CCBAS-500-6 
Single pack Pack of 10 pieces	VM2-180 VM2-180-10	Use VM2-180	VM2-200 VM2-200-10	Use VM2-200
Fixation screw for T-Connect Supplied with the T-Connect, it can also be ordered separately as a spare	 M 1.8.....		 M 2.0.....	

Recommended torque for T-Connect: 20-25 Ncm.

See technical characteristics of Gr. 5 titanium and PMMA on pages 196 and 198.

T-Connect for Shelta implants

prosthetic component \emptyset	3.30	3.80	4.25	5.00
for implants	Shelta 3.80	Shelta 3.80 - 4.25 5.00 - 6.00	Shelta 4.25 - 5.00 - 6.00	Shelta 5.00 - 6.00
T-Connect Engaging Cone H. 4 mm Fixation screw included	A-BASTZR-S-330-4 	A-BASTZR-S-380-4 	AS-BASTZR-S-425-4 	AS-BASTZR-S-500-4 
T-Connect Engaging Cone H. 6 mm Fixation screw included	A-BASTZR-S-330-6 	A-BASTZR-S-380-6 	AS-BASTZR-S-425-6 	AS-BASTZR-S-500-6 
T-Connect Non engaging Cone H. 4 mm Fixation screw included	A-BASTZR-M-330-4 	A-BASTZR-M-380-4 	AS-BASTZR-M-425-4 	AS-BASTZR-M-500-4 
T-Connect Non engaging Cone H. 6 mm Fixation screw included	A-BASTZR-M-330-6 	A-BASTZR-M-380-6 	AS-BASTZR-M-425-6 	AS-BASTZR-M-500-6 
Sleeve for wax-up modelling on T-Connect supports with cone H. 4.00 mm	A-CCBAS-330-4 	A-CCBAS-380-4 	A-CCBAS-425-4 	A-CCBAS-500-4 
Sleeve for wax-up modelling on T-Connect supports with cone H. 6.00 mm	A-CCBAS-330-6 	A-CCBAS-380-6 	A-CCBAS-425-6 	A-CCBAS-500-6 
Single pack Pack of 10 pieces	VM2-180 VM2-180-10	Use VM2-180	Use VM2-180	Use VM2-180
Fixation screw for T-Connect Supplied with the T-Connect, it can also be ordered separately as a	 M 1.8.....			

Recommended torque for T-Connect: 20-25 Ncm.

Definitive single screw retained rehabilitation with T-Connect: luting technique

Screw the engaging T-Connect support on the precision model onto the analog using a screwdriver of the HSM series. Insert a castable sleeve of the same height of the cementing cone of the T-Connect, of 4.00 or 6.00 mm.

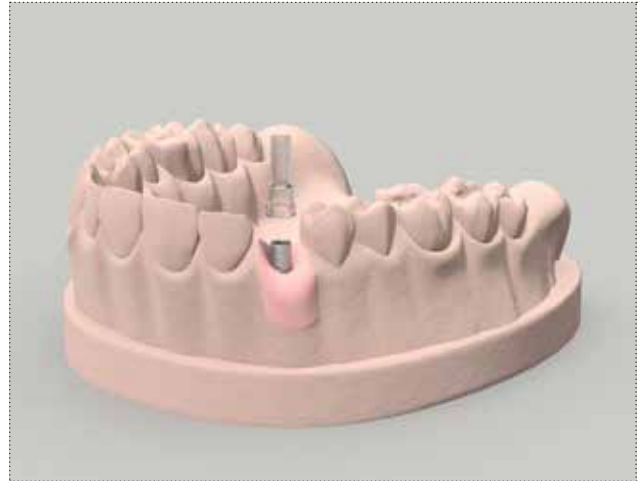

Reduce the castable sleeve to a size compatible with the patient's vertical dimension using an abrasive disk.

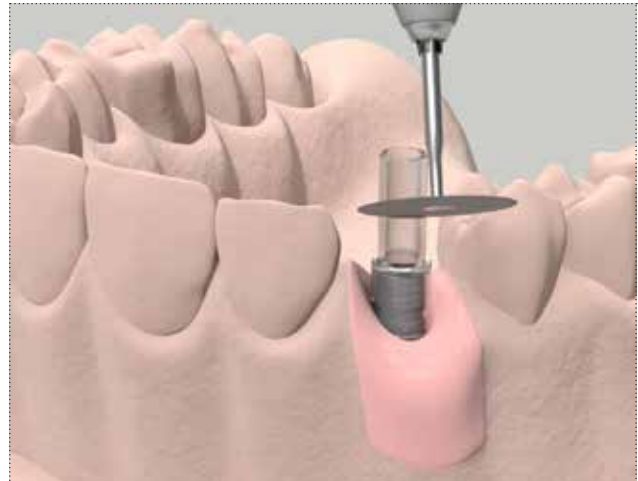

Model a crown in wax or resin on the castable sleeve and use a screw to keep the screw hole free.

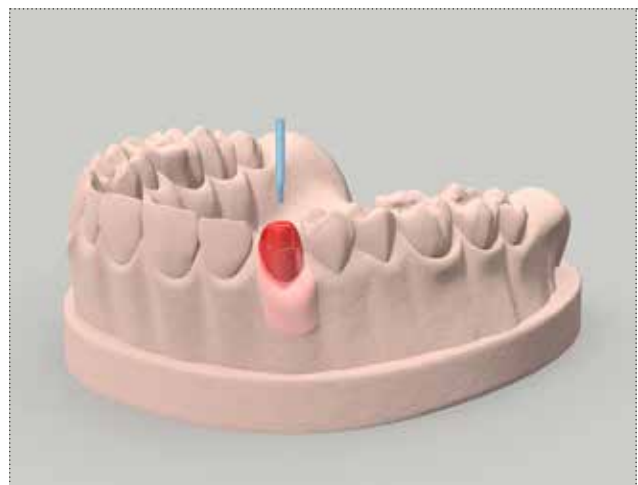

Cast the crown in wax or resin together with the reduced castable sleeve incorporated inside.

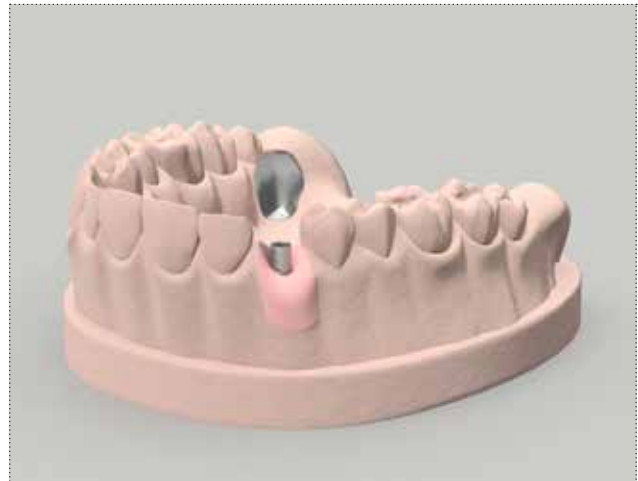

Ceramize the cast crown and lute it on the model: turn the crown upside down and insert a resin cement in the hole to lute the T-Connect. Polymerize following the manufacturer's instructions.

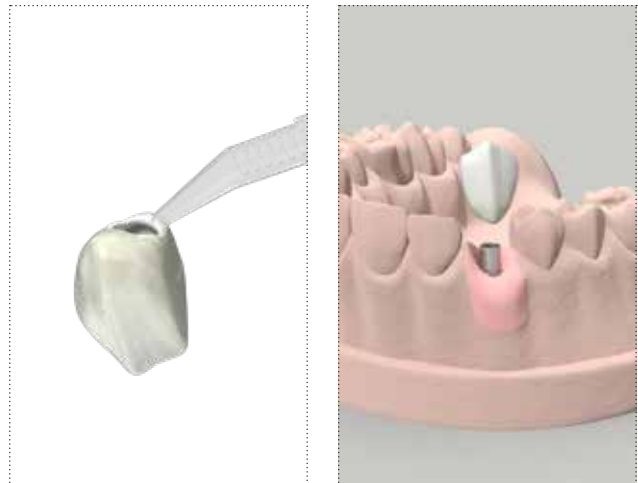

Tighten the crown onto the implant with the supplied screw, applying a maximum torque of 20-25 Ncm.

Important warning

It is recommended always to use test screws for the laboratory phases and to keep the new screw supplied for the final fastening in the oral cavity.

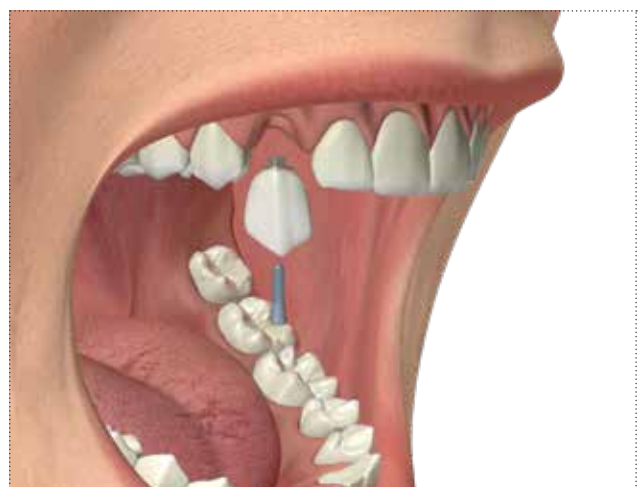

Definitive multiple screw retained rehabilitation with T-Connect: luting technique

Screw the engaging T-Connect supports on the precision model onto the analogs using a screwdriver of the HSM series. Insert the castable sleeves of the same height of the cementing cones of the T-Connect, of 4.00 or 6.00 mm.



Reduce the castable sleeves to a size compatible with the patient's vertical dimension using an abrasive disk.

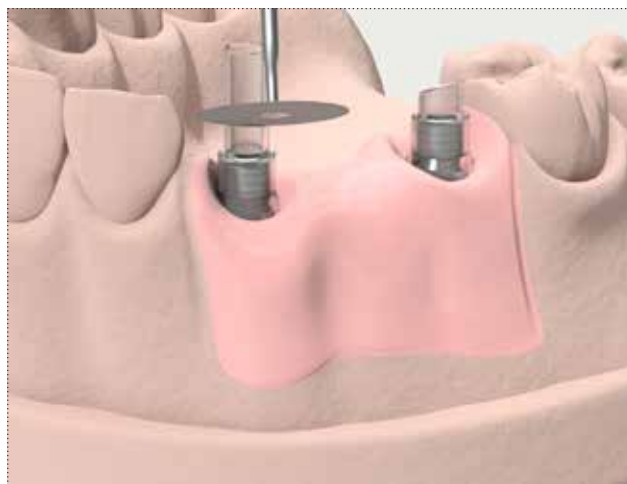

Model a bridge in wax or resin on the castable sleeves and use a screw to keep the screw holes free.



Cast the bridge in wax or resin together with the reduced castable sleeves incorporated inside.



Ceramize the bridge and lute it on the model: turn the bridge upside down and insert a resin cement in the hole to lute the T-Connect. Polymerize following the manufacturer's instructions.



Tighten the bridge onto the implants with the supplied screw, applying a maximum torque of 20-25 Ncm.

Important warning

It is recommended always to use test screws for the laboratory phases and to keep the new screw supplied for the final fastening in the oral cavity.









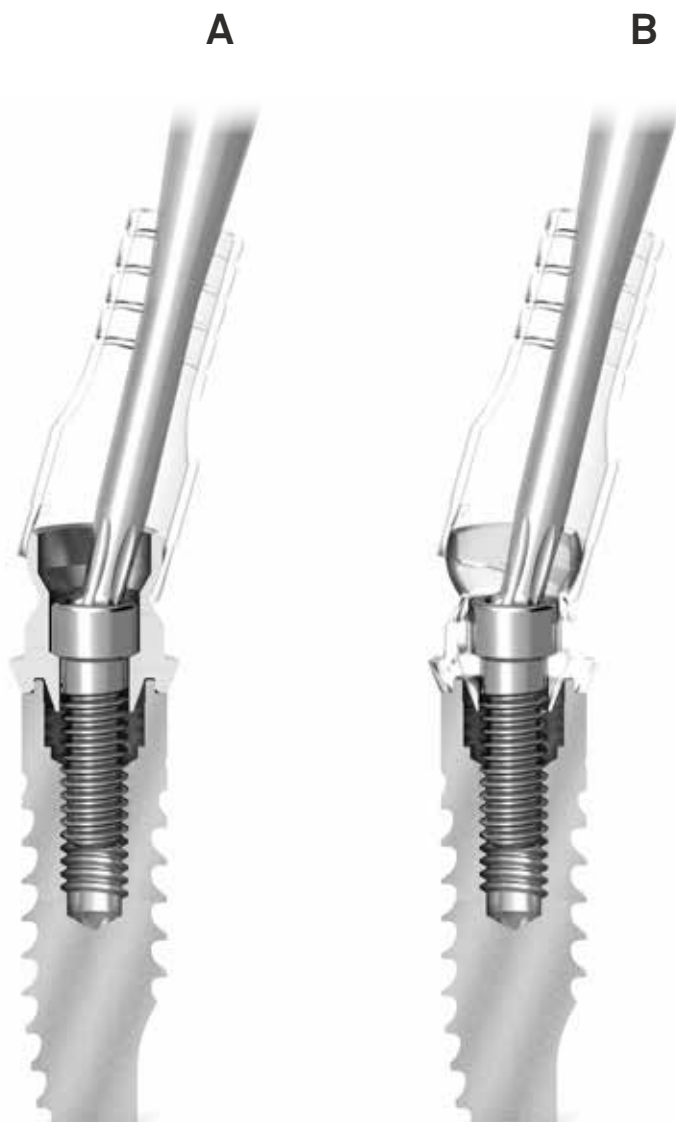

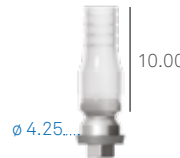

Definitive rehabilitation with Dynamic Abutments

The Dynamic Abutment* post is a patented solution that allows the creation of aesthetic prosthesis onto implants, moving the hole for the fixation screw to a palatal or lingual position, solving disparallelism problems, with a liberty of angulation up to 28°. This is made possible by the synergy between the non engaging castable sleeve on the head of the abutment and screwdriver with its specially designed hexalobular tip, which allows the head of the screw to be engaged even in the presence of extreme angulations.

The Dynamic Abutment is available with a base in cobalt chrome for overcasting (**img. A**) and in total castable polymer (**img. B**), in engaging version for single crowns and non engaging for multiple structures.

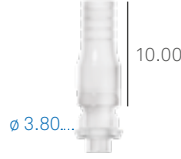
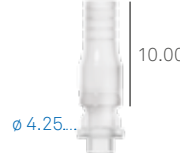

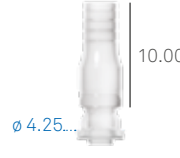
Dynamic Abutment for Premium Kohno and Shelta implants

prosthetic component ø	3.30	3.80	4.25
for implants	Premium 3.30 - 3.80 Kohno 3.80 Shelta 3.80	Premium 3.80 Kohno 3.80 Shelta 3.80 - 4.25 - 5.00 - 6.00	Premium 4.25 Kohno 4.25
Dynamic Abutment Engaging Cobalt chrome base for overcasting Fixation screw not included	PD3PKH330/CC 	PD3PKH380/CC 	PD3PKH425/CC 
Dynamic Abutment Non engaging Cobalt chrome base for overcasting Fixation screw not included	PD3PKR330/CC 	PD3PKR380/CC 	PD3PKR425/CC 
Dynamic Abutment Engaging Entirely castable Fixation screw not included	PD3PKH330/P 	PD3PKH380/P 	PD3PKH425/P 
Dynamic Abutment Non engaging Entirely castable Fixation screw not included	PD3PKR330/P 	PD3PKR380/P 	PD3PKR425/P 
Fixation screw for Dynamic Abutment Not included, can be ordered separately	TPDH18L66 	Use TPDH18L66	TPDH2L66 

Recommended torque for the Dynamic Abutments: 20-25 Ncm.

description	code
Screwdriver for Dynamic Abutment Length 24 mm	DSPDCLH-24 
Screwdriver for Dynamic Abutment Length 32 mm	DSPDCLH-32 

Definitive single screw retained rehabilitation with Dynamic Abutment

Screw the engaging Dynamic Abutment with a cobalt chrome base onto the analog on the precision model using the specific fixation screw with the screwdriver of the most suitable length between the ones available, of 24 or 32 mm.

Important warning

It is recommended always to use test screws for the laboratory phases and to keep the new screw supplied for the final fastening in the oral cavity. The fixation screw is not included, it must be ordered separately.



Manually guide the castable rotating portion of the abutment according to the prosthetic axis identified in the treatment plan.

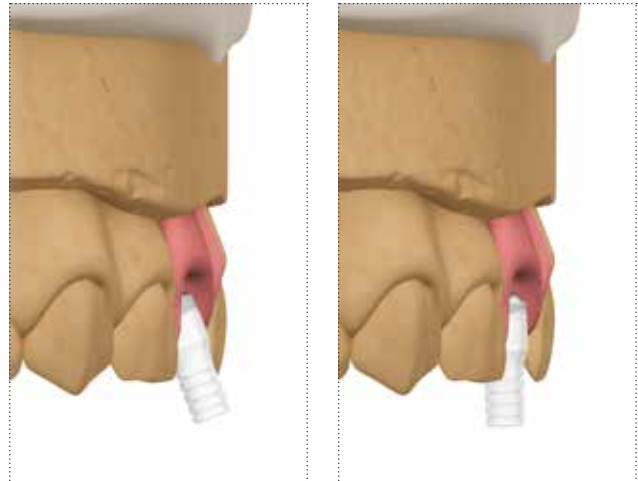

Fix the castable rotating portion in the desired position with castable resin. If necessary, remove or reduce the metal part to obtain a profile without finishing line.

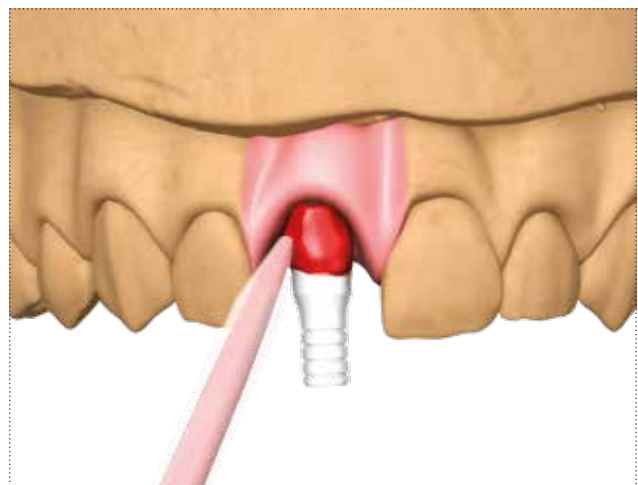

Reduce the castable sleeve to a size compatible with the patient's vertical dimension with an abrasive disk.

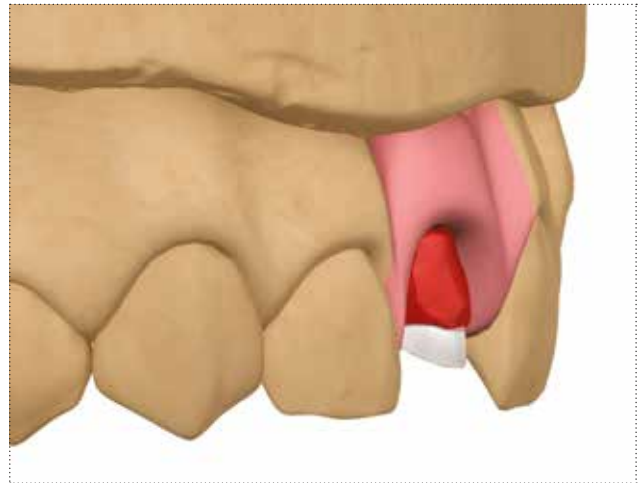

According to the standard protocol, model a crown in wax or resin and unscrew it taking advantage of the specific design of the screwdriver tip.

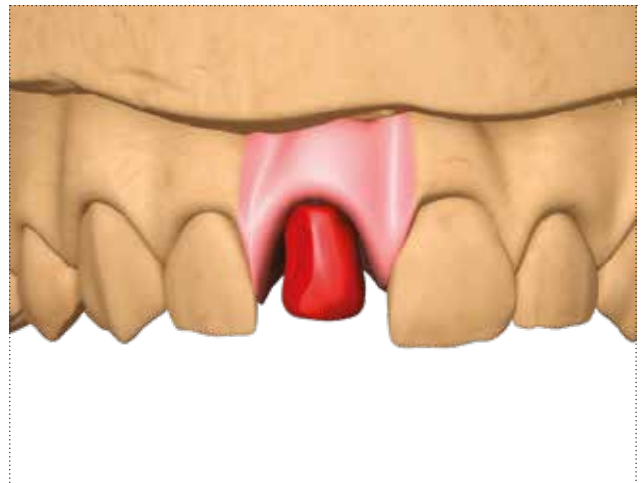

Overcast the structure as usual and finish the base, so as to avoid obstacles for soft tissues adaptation.



Check the crown on the model or in the patient's mouth for possible modifications. Ceramize as usual.

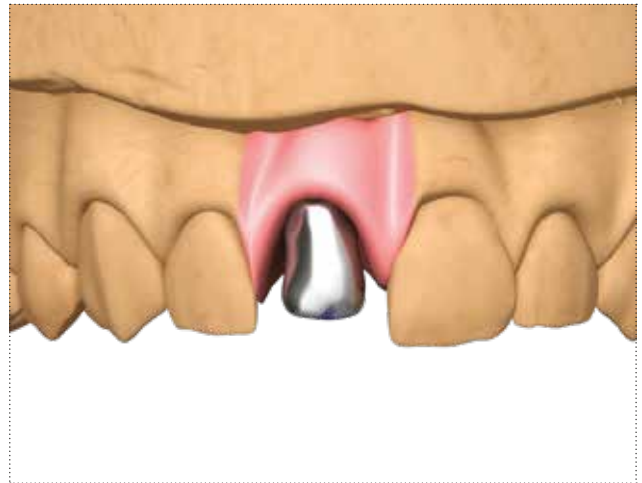

Tighten the structure in the patient's mouth applying a torque 20-25 Ncm and cover the screw hole with resin or composite.



Definitive multiple screw retained rehabilitation with Dynamic Abutment

Screw the Dynamic Abutments with a cobalt chrome base onto the analogs on the precision model using the specific fixation screw with the screwdriver of the most suitable length between the ones available, of 24 or 32 mm.

Important warning

It is recommended always to use test screws for the laboratory phases and to keep the new screw supplied for the final fastening in the oral cavity.

The fixation screw is not included, it must be ordered separately.

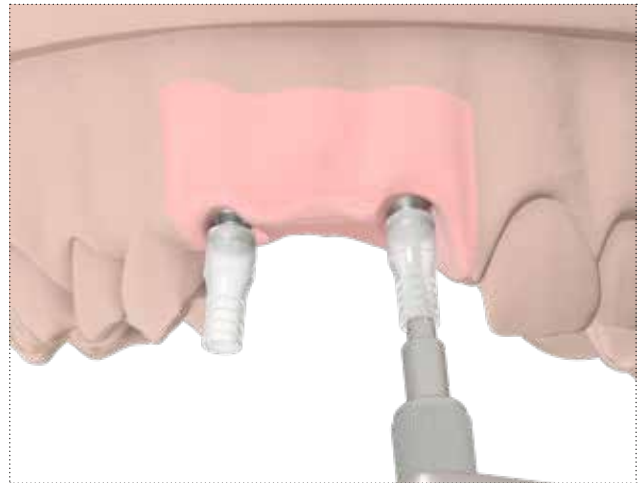

Manually guide the rotating portion of the abutments according to the prosthetic axis identified in the treatment plan.

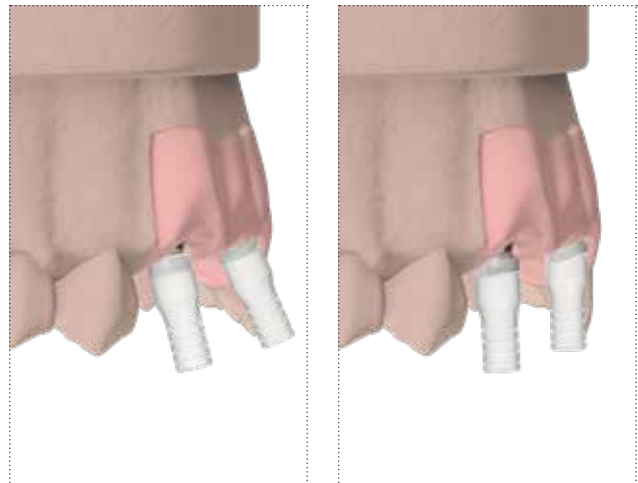

Fix the rotating portion in the desired position with castable resin.

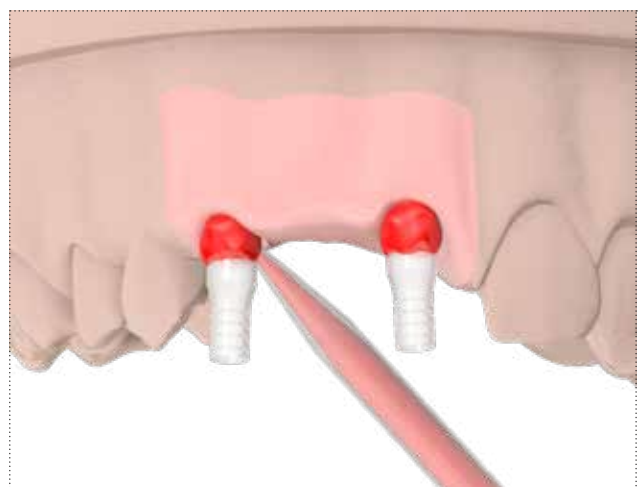

Reduce the castable sleeves to a size compatible with the patient's vertical dimension with an abrasive disk.

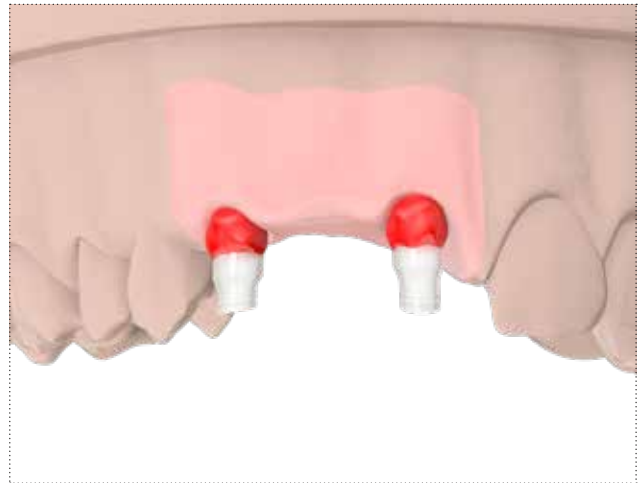

According to the standard protocol, model a bridge in wax or resin and unscrew it taking advantage of the specific design of the screwdriver tip.

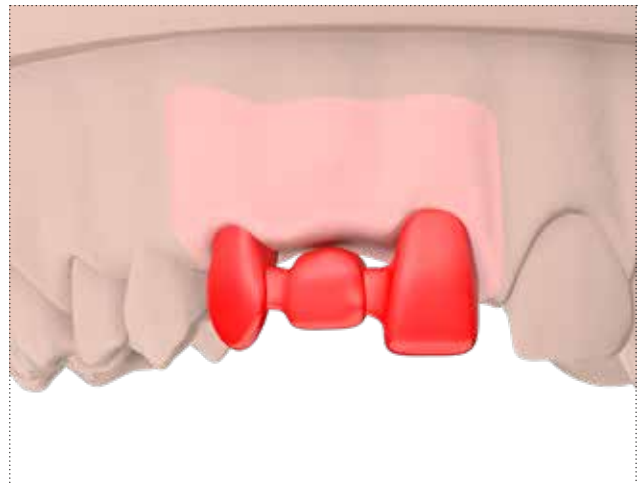

Overcast the structure as usual and finish the base, so as to avoid obstacles for soft tissues adaptation.



Check the structure on the model or in the patient's mouth for possible modifications. Ceramize as usual.

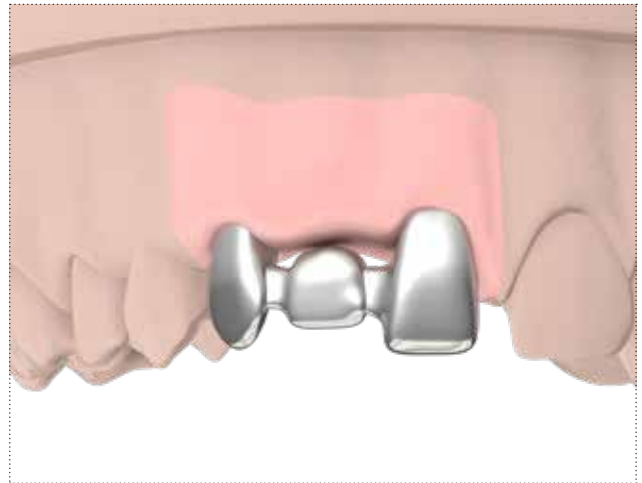

Tighten the structure in the patient's mouth applying a torque 20-25 Ncm and cover the screw holes with resin or composite.



Composition of the materials

Gr. 2 titanium* ASTM F67-13, ISO 5832-2:2012

chemical composition	maximum allowed values (%)	tolerance
nitrogen	0.03	+/- 0.02
carbon	0.08	+/- 0.02
hydrogen	0.015	+/- 0.002
iron	0.30	+/- 0.10 (%<0.25) +/- 0.15 (%>0.25)
oxygen	0.25	+/- 0.02 (%<0.20) +/- 0.03 (%>0.20)
titanium	remainder	-

* This technical information complies with the express specifications of the regulations in force on the use of titanium Gr. 2 in implantology.

Gr. 4 titanium (cold worked)* ASTM F67-13, ISO 5832-2:2012

chemical composition	maximum allowed values (%)	tolerance
nitrogen	0.05	+/- 0.02
carbon	0.10	+/- 0.02
hydrogen	0.015	+/- 0.002
iron	0.25	+/- 0.10 (%<0.25) +/- 0.15 (%>0.25)
oxygen	0.20	+/- 0.02 (%<0.20) +/- 0.03 (%>0.20)
titanium	remainder	-

This technical information complies with the express specifications of the regulations in force on the use of Gr. 4 titanium in implantology:

- ASTM F67-13: Standard Specification for unalloyed titanium, for surgical implant applications.
- ISO 5832-2: 2012: Implants for surgery – Metallic materials – Part 2: Unalloyed titanium.

Please note: the use of **cold-worked** Gr. 4 titanium bars for the production of Sweden & Martina implants allows the exploitation of mechanical characteristics higher than those required by applicable standards. Furthermore, the excellent results documented **since 1996** corroborate the choice of the cold-working production process and of **ZirTi surface treatments**, which express and enhance the raw material potential selected by Sweden & Martina.

Gr. 5 titanium* ASTM F136-13, ISO 5832-3:2012

chemical composition	maximum allowed values (%)	tolerance
nitrogen	0.05	+/- 0.02
carbon	0.08	+/- 0.02
hydrogen	0.012	+/- 0.002
iron	0.25	+/- 0.10
oxygen	0.13	+/- 0.02
aluminium	5.5÷6.5	+/- 0.40
vanadium	3.5÷4.5	+/- 0.15
titanium	remainder	-

* This technical information complies with the express specifications of the regulations in force on the use of Gr. 5 titanium in implantology:

- ASTM F 136-13: Standard Specification for wrought Titanium-6 Aluminium-4 Vanadium Eli (Extra low interstitial) Alloy for surgical applications;
- ISO 5832-3:2012: Implants for surgery – Metallic materials – Part 3: Wrought Titanium-6 Aluminium-4 Vanadium Alloy.

Reef resin

reef resin	
description	acrylic material resistant to bacterial colonization
colour	translucent white

physical and mechanical properties	
hardness (ASTMD92/ISO 6507)	17.5 +/- 0.5 Vickers
tensile strength	28.3 +/- 3.8 MPa
compressive strength (ASTM D3410)	404.2 +/- 22 MPa
bending strength (ASTM D790M)	67.5 +/- 15.3 MPa

PEEK

PEEK	
chemical designation	polyether ether ketone
colour	opaque white cream

physical and mechanical properties	
density	1.14 g/cm ³
modulus of elasticity in tension (DIN EN ISO 527-2)	4100 MPa
yield strength (DIN EN ISO 527-2)	>90 MPa
yield strength at 0.2% (DIN EN ISO 527-2)	>70 MPa
elongation at 0.2 % (DIN EN ISO 527-2)	5 %
elongation at break (DIN EN ISO 527-2)	13 %
flexural strength (DIN EN ISO 178)	174 MPa
modulus of flexural elasticity (DIN EN ISO 178)	4000 MPa
modulus of compressibility (EN ISO 604)	3500 MPa

thermal properties	
glass transition temperature	150 °C
maximum temperature for short-term use	300 °C
maximum temperature for continuous use	260 °C

chemical properties	
absorption at 23°C in 24/96 hours (DIN EN ISO 62)	0.02/0.03%

PMMA

PMMA	
chemical designation	polymethylmethacrylate
colour	transparent

physical and mechanical properties	
density	1.19 g/cm ³
yield strength (DIN EN ISO 527-2)	80 MPa
elongation at break (DIN EN ISO 527-2)	5.5 %
modulus of elasticity in tension (DIN EN ISO 527-2)	3300 MPa
hardness ball falling (ISO 2039-1)	175 MPa
impact strength (Charpy) (DIN EN ISO 179-1eU)	15 kJ/m ²

thermal properties	
maximum temperature for continuous use	80 °C
maximum temperature for short-term use	85 °C
coefficient of linear thermal expansion (0-50 °C, long) (DIN 53752-A)	7x10 ⁻⁵ 1/K
thermal conductivity (DIN 52612)	0.19 W/(K*m)
Heat Deflection Temperature (HDT-B) at 0.46 MPa (DIN ISO 75)	113 °C
Heat Deflection Temperature (HDT-A) at 1.80 MPa (DIN ISO 75)	105 °C

POM

POM	
chemical designation	polyoxymethylene (copolymer)
colour	opaque white

physical and mechanical properties	
density	1.41 g/cm ³
yield strength (DIN EN ISO 527-2)	67 MPa
elongation at break (DIN EN ISO 527-2)	32%
modulus of elasticity in tension (DIN EN ISO 527-2)	2800 MPa
hardness ball falling (ISO 2039-1)	165 MPa
impact strength (Charpy) (DIN EN ISO 179-1eU)	Not broken

thermal properties	
melting point (DIN 53765)	166 °C
maximum temperature for continuous use	100 °C
maximum temperature for short-term use	140 °C
specific thermal capacity	1,4 J/(g*K)
thermal expansion (CLTE) 23°C-60°C (DIN EN ISO 11359-1;2)	13x10 ⁻⁵ 1/K
thermal expansion (CLTE) 23°C-100°C (DIN EN ISO 11359-1;2)	14x10 ⁻⁵ 1/K

chemical properties	
absorption (DIN EN ISO 62) 24h/96h (23 °C)	0.05/0.1%

Gold alloy

gold alloy	gold alloy 1	gold alloy 2
designation	gold alloy 1	gold alloy 2
colour	white	yellow

composition	% of reference	
Au	60 %	> 68.60 %
Pt	24 %	2.45 %
Pd	15 %	3.95 %
Ir	1 %	0.05 %
Ag	-	11.85 %
Cu	-	10.60 %
Zn	-	2.50 %
Au+Pt group metals	-	75.35 %
Ru	-	-

physical and mechanical properties		
density	18.1 g/cm ³	15.0 g/cm ³
melting range	1400 ÷ 1460 °C	880 ÷ 940 °C
modulus of elasticity in tension	115 GPa	97 GPa
Vickers hardness HV5 (gold alloy 2)	160 (annealed) 250 (tempered) 220 (after deformation) 240 (after casting)	> 240
limit of elasticity	400 MPa (annealed) 700 (after deformation) 800 (after casting)	> 710 MPa
elongation	20 % (annealed) 15 % (after deformation) 1 % (after firing)	> 4 %

- Gold alloy "1": all castable posts with a premade alloy base.
- Gold alloy "2": CAP-1 cap for ball attachments in gold alloy.

Cobalt chrome alloy

chemical composition	maximum allowed values (%)
C	0.10
Mn	1.00
Cr	26.00 ÷ 30.00
Ni	1.00
Mo	5.00 ÷ 7.00
N	0.25
Fe	0.75
Co	remainder

physical and mechanical properties	
density	8.27 g/cm ³
modulus of elasticity in tension	241 GPa
yield strength (0.2%)	585 MPa
tensile stress	1035 MPa
elongation at yield	25 %
section reduction	23 %
hardness	30 HTc

thermal properties	
melting range	1400 ÷ 1450 °C
coefficient of thermal expansion	
at 500 °C	14.15
at 600 °C	14.47
thermal conductivity	
at 600 °C	25.76W/mK

Advice for overcasting with base alloys

By **Loris Zamuner, dental clinician**

Casting with base alloys, which is less predictable than casting with precious alloys, increases the difficulty of maintaining precision at the level of the prosthetic connection, because apart from the factors involving intimate contact between the alloys and mechanical resistance, problems of corrosion may also emerge, as dental technicians are well aware.

As these alloys are oxidized when heated, additional precautions must be adopted when preparing models and during coating and casting procedures, to avoid not only mechanical but also biological complications (e.g. gingival tattoos, namely the blackish marks caused by the redox reaction of prosthesis metals, which are extremely difficult to treat and remove).

With regard to this we would like to offer some advice, which although it may not completely eliminate these problems, may be useful in the laboratory for the correct use of castable posts with a cobalt chrome base:

- Remove the castable sleeve from the base and seal the interstitial space with wax or castable resin, to prevent the possible formation of cracks.
- Apply a layer of deoxidizing solution (e.g. flux) to the metal surface before repositioning and fixing the castable sleeve. This may reduce the quantity of oxides produced during heating of the alloy.
- Modelling must very clearly delimit the area of the junction between the castable sleeve and the prefabricated base with a well-defined closure edge, so as to prevent the overcast alloy from penetrating the base of the post.
- The formation of pins for the creation of cylinders must be carried out in an area with an adequate surrounding volume, to prevent the injected alloy from cooling before it has completely filled the final form. Do not position casting pins in thin areas, to avoid deformations caused by the heat of the molten alloy.
- The expansion of the refractory casting coating must be limited to a minimum, to prevent the formation of spaces between the metal base and the coating caused by the different expansion of the two layers. If the coating and the metal base are not in intimate contact, a thin film of metal could form on the prefabricated base, which if it reaches the connection platform between the implant and the prosthesis could affect precision, giving rise to evident biomechanical and biological problems.
- All parts of the cylinder must be heated uniformly. Since internally it incorporates the prefabricated metal components, which by their very nature absorb heat, it is advisable to maintain the final heating temperature for an extended time, then raising it by about 20–30 °C higher than the temperature recommended by the manufacturer of the alloy.
- When choosing the alloy for overcasting, its fusion temperature must be attentively considered with respect to the fusion temperature of the component to be overcasted, which must be around 80–100 °C higher, to avoid deformations but at the same time to ensure correct bonding between the two alloys.
- After casting, leave the cylinder to cool slowly, to prevent the formation of stresses between the two alloys.
- Avoid contact between the ceramic and the base alloy while firing the ceramic, because the different thermal expansion coefficients may cause cracking in the coating layer.
- Where possible (in non-aesthetic areas) keep the area of interface between the prefabricated base and the overcast structure out of the gingival sulcus.
- With composite screw retained prostheses, incorporate the interface line between the prefabricated base and the overcast structure inside the aesthetic coating.
- Use the same type of alloy for the entire prosthetic reconstruction, to avoid partial weakenings, breakages and the incorrect distribution of forces on the implants.

Remember that this technique may be subject to the problems of mechanical resistance, corrosion and galvanic reactions typical of precious alloys, which are therefore present to a greater extent in base alloys.

General clinical indications

Modern implant prosthetics, for both immediate or deferred loading, is a widely experimented and reliable discipline that is able to resolve virtually all problems of functional or aesthetic edentulism. An implant prosthesis may replace a single tooth (implant-supported crown), a group of adjacent teeth (implant-supported bridge), or an entire dental arch.

This manual addresses the production screw-retained prostheses for the rehabilitation of cases of total edentulism.

Implant-prosthetic rehabilitation must respect several fundamental criteria:

- the presence of a certain quantity of bone;
 - the primary stability of the inserted implants;
 - good periodontal (gingival) support;
 - the absence of bruxism (tooth grinding) and serious malocclusions;
- the presence of good occlusal balance (correct masticatory occlusal plane).

Warnings and contraindications

When assessing patients, in addition to considering their suitability for implant-prosthetic rehabilitation, it is usually necessary to take into account the contraindications applicable to all operations of dental surgery.

These may include:

- clotting disorders, anticoagulant therapies in progress;
- healing or bone regeneration disorders;
- decompensated diabetes mellitus;
- metabolic or systemic diseases that compromise tissue regeneration, and with effects in particular on tissue healing and bone regeneration;
- alcohol abuse, smoking and use of drugs;
- immunosuppressive therapy, such as chemotherapy and radiotherapy;
- infections and inflammations, such as periodontitis and gingivitis;
- poor oral hygiene;
- insufficient motivation;
- occlusion and/or articulation disorders, and also inadequate interocclusal space;
- inadequate alveolar process.

It is contraindicated to fit implants and implant restorations in patients with poor general or oral health, those who are unable to monitor their general conditions properly or those who have had organ transplants. Psychologically unstable patients, alcohol or drug abusers and poorly motivated or uncooperative patients should also be considered unsuitable for this kind of treatment. Patients with poor periodontal health should first be treated and allowed to recover. In the presence of a lack of bone substance or poor quality of the receiving bone, such as to compromise the stability of the implant, suitable guided tissue regeneration must be performed prior to implant treatment and bone grafting procedures. Contraindications can also include: allergies to titanium, acute or chronic infectious diseases, sub-acute chronic maxillary osteitis, systemic diseases, endocrine disorders, diseases resulting in microvascular disorders, pregnancy, breastfeeding, previous exposure to radiation, haemophilia, granulocytopenia, use of steroids, diabetes mellitus, kidney failure and fibrous dysplasia. The normal contraindications common to all oral surgery must also be observed. Patients following anti-coagulant, anticonvulsant and immunosuppressant therapies, with active inflammatory-infective processes of the oral cavity, and patients with BUN and creatinine values outside the norm, must not be subjected to surgery. Patients with cardiovascular disease, hypertension, thyroid or parathyroid diseases, malignant tumours found in the five years preceding the operation or nodular swellings must also be assessed with particular attention. Chemotherapies reduce or eliminate the ability of osseointegration, and patients undergoing these treatments must therefore be carefully screened before being rehabilitated with oral implant prostheses. Numerous cases of bisphosphonate-associated peri-implant osteonecrosis of the mandible have been reported in literature. This problem applies in particular to patients receiving intravenous treatments.

Prostheses must always be planned in advance. Prosthetic planning must be carried out in collaboration with the dental technician. Guided prosthetic insertion of implants facilitates the work of the practitioner, and offers greater guarantees of longer prosthesis lifespan. Complete clinical, radiological and radiographic documentation should be collected and stored on file. Every product pack shows the product code, a description of contents and the batch number. These details are also indicated on the labels to be attached to the patient's records, and must always be cited by the practitioner in any correspondence regarding the products. When handling these medical devices, both during actual use and during cleaning and sterilization procedures, surgical gloves must always be worn for individual protection against bacterial contamination. Failure to follow this precaution may expose the patient to infection. Packaging conforms to European standards.

Information on applicable standards

The medical devices addressed by this instruction manual have been designed and manufactured in accordance with the most recent directives and harmonized standards applicable to the materials used, production processes, the information supplied and packaging.

Every product pack shows the product code, a description of contents and the batch number. These details, which are also indicated on labels included in packs, must always be cited by the practitioner in any correspondence regarding the products. The prosthetic components and instruments manufactured by Sweden & Martina contains no materials of human or animal origin, and are free from phthalates. Patients must be asked if they are allergic to any of the materials used. Although titanium allergies are possible, these are very rare. Patients should therefore always be asked if they have allergies of this type. Refer to pages 84–90 for technical details on all materials used, for checks on the respective chemical compositions, and for physical and mechanical characteristics.

Identification of the manufacturer

Manufacturer of the prosthetic components and instruments described in this manual:

Sweden & Martina

Via Veneto 10
35020 Due Carrare (Padova) – Italia
Tel. +39 049.9124300 - Fax + 39 049.9124290
e-mail: info@sweden-martina.com
www.sweden-martina.com

Intended use and risk classes

In accordance with Directive 93/42/EEC adopted in Italy with Law Decree 46/97 dated 26 March 1997, Annex IX, Sweden & Martina identifies the prosthetic components and instruments described in this manual as medical devices, and identifies their risk class as indicated in the following chart.

In particular, the prosthetic components described are medical devices intended for use in the oral cavity. The prosthetic components have the following functions:

- reconditioning of the gingiva (healing abutments, long-term devices);
- taking of impressions (transfers and respective fixing screws, temporary devices, with a certified duration of no more than 60 consecutive minutes);
- anchorage to dental implants for the support of dental prostheses (temporary and definitive posts, their respective fixing screws, long-term devices).

The prosthetic components are disposable. "Disposable" is taken to mean that every single device must be used only for a single patient.

It is routine practice for a prosthetic component to be tested several times in the patient's mouth and then sent to the dental technician for completion of the prosthesis. This is acceptable practice, and does not compromise the concept of "disposable", on condition that the same prosthetic component is used always and only for the same patient. In the case of multiple prostheses, it is essential for the same component to be used always and only in the same position and in association with the same implant, meaning that components must not be interchanged during the same rehabilitation procedure.

Failure to respect these instructions may compromise the precision of the components.

Any reuse for different patients must be considered to be an "off-label" use, and in these cases, Sweden & Martina SpA declines all liability.

The instruments are reusable medical devices intended for temporary use in the oral cavity (no more than 60 consecutive minutes). The function of the instruments is to tighten and unscrew all connection screws (surgical cover screws, healing abutments, screws for posts and abutments, prosthetic screws, transfer screws, etc).

device	classification	pack	annex IX rule	risk class
Healing abutments	Invasive long-term surgical devices	Disposable, non-sterile	8	2B
Transfers	Invasive short-term surgical devices	Disposable, non-sterile, complete with respective fixing screws	7	2A
Caps for taking impressions on P.A.D. abutments	Invasive short-term surgical devices	Disposable, non-sterile	7	2A
Transfer screws	Short-term accessories for invasive surgical medical devices	Disposable, non-sterile	5	2A
Abutment and components for screw-retained prostheses, conventional type or for the P.A.D. technique	Invasive long-term surgical devices	Disposable, non-sterile, complete with fixing screws	8	2B
Castable with a metal base	Long-term non-surgical invasive devices intended for the oral cavity	Disposable, non-sterile, complete with fixing screws	5	2A
Tightening screws for posts, abutments and overstructures (post and prosthesis screws)	Long-term accessories for invasive surgical medical devices intended for the oral cavity	Disposable, non-sterile. Supplied together with the respective posts or individually, in single or multiple packs	5	2A
Analogs	Medical device, non-invasive	Disposable, non-sterile	1	1
Spare castable sleeves	Medical device, non-invasive	Disposable, non-sterile without fixing screws	5	1
Drivers, drivers/screwdrivers and extension with shank for ratchet	Reusable invasive surgical instruments for temporary use (for less than 60 consecutive minutes) intended for fitting to an active medical device	Reusable, non-sterile	6	2A
Drivers/screwdrivers, drivers, hexagonal keys, manual drivers, parallelism pins for manual use	Invasive surgical instruments for temporary use (for less than 60 consecutive minutes) intended for fitting to an active medical device	Reusable, non-sterile	6	1

All the devices listed, even though they are intended for use in all patients with suitable therapeutic indications, must be used only by professional medical personnel with the necessary qualifications and training, and by dental technicians in the context of the preparation of prostheses.

Special warnings

When tightening healing abutments and definitively tightening screws for posts or prostheses, the following tightening torques must be respected:

description	recommended torque
Healing abutments	8-10 Ncm
Transfer screws	8-10 Ncm
Through screws for tightening posts and abutments onto implants	20-25 Ncm
Through screws for tightening prosthetic overstructures onto abutments	20-25 Ncm
Components screwed directly onto implants (e.g. straight P.A.D. and PLAIN abutments without a fixation screw form a solid body with the screw)	25-30 Ncm
Through screws for tightening overstructures screwed directly onto implants (without using intermediate abutments)	25-30 Ncm

Excessive tightening torques may weaken the mechanical structure of screws and compromise prosthetic stability, with possible damage to the implant connection. Totally castable posts must be screwed onto models manually and/or with a torque not exceeding 8–10 Ncm.

Maintenance

Complications associated with implant prostheses have been reported in literature. These complications may lead to a loss of osseointegration and to implant failure. Correct maintenance by the patient, satisfactory home dental hygiene and regular check-ups during professional hygiene sessions increase the lifespan of the device. Complications such as for example the slackening of the screws fixing posts to implants can be easily avoided with regular check-ups. If post screws need to be tightened, this must be done by the clinician, using suitable instruments with control over tightening torque. The calibration of these instruments should be checked regularly. If patients become aware that maintenance may be required, they should contact their clinician as soon as possible, so that the necessary work to restore correct orthodontic functionality can be carried out. Delays in consulting the clinician may lead firstly to the fracture of the connection screw or of the prosthesis, and secondly to the loss of the implant, thereby compromising rehabilitation results. Clinicians must make this clear to their patients. Complications may be biological (impaired integration) or mechanical (fracture of a component due to excessive loads). If there are no complications, the lifespan of devices and of the entire prosthetic apparatus depends on its mechanical resistance according to the fatigue that accumulates in the device. Any decementation of definitively cemented crowns or bridges that may allow impact shocks to be transmitted to implant structures may cause fractures to these structures. Sweden & Martina SpA has subjected implant/post/fixation screw assemblies to the required cycle of 5,000,000 fatigue resistance tests. The assemblies passed these tests with positive results. The fatigue resistance tests were carried out in compliance with specific requirements, and were further validated using finite element calculations.

Cleaning / sterilization / conservation of prosthetic components and instruments

Caution! All prosthetic components and instruments for dental implants are supplied as NON-STERILE. Before use, all devices must be cleaned, disinfected and sterilized using the following procedures validated by Sweden & Martina SpA. These procedures must be performed before intraoral use of the devices, meaning before every use in testing and trial operations and compulsorily before definitive prosthetic loading. The repetition of the processes described in this sections does not modify the characteristics of these devices.

Failure to follow these instructions may cause cross-infections.

a. Cleaning: Containers and transports to be used for washing: no special requirements. In case of automated cleaning, use an ultrasound bath with a suitable detergent solution (e.g. DURR ID212, DC1 or equivalent). Follow the manufacturer's instructions for detergent concentrations and washing times. Use demineralized water to prevent the formation of stains and marks. When draining washing water, check that all residues have been removed from devices, holes, etc. If necessary, repeat the operation or clean manually.

In case of manual cleaning, use a suitable neutral detergent (e.g. DURR ID212, DC1 or equivalent) and follow the manufacturer's instructions. Brush products with a soft-bristled brush under abundant running water. Using the brush, apply the detergent to all surfaces. Rinse with distilled water for at least four minutes. Ensure that the running water passes abundantly through any holes and other openings.

After rinsing, thoroughly dry the components and pack them in appropriate sterilization bags. Do not exceed 120°C when performing a drying cycle in a washing and disinfection appliance.

b. Sterilization: In a vacuum autoclave, sterilizing as follows:

- autoclave (gravity displacement cycle) at a temperature of 121°C with minimum exposure of 30 minutes and drying cycle of 15 minutes;
- autoclave (dynamic air removal cycle) at the temperature of 132°C with minimum exposure of 4 minutes and drying cycle of 20 minutes.

c. Storage: After sterilization, the product must remain in the sterilization bags. Bags must only be opened immediately before use.

In normal conditions, sterilization bags are usually able to maintain the sterility of their contents, unless the wrapping is damaged. Do not therefore use components if the bags in which they were kept are damaged, and resterilize them in new bags before using again. The storage time of products sterilized in bags must not exceed the time recommended by the manufacturer of the bags.

Products must be stored in a cool and dry place, away from sunlight, water and heat sources.

Cleaning, sterilization and storage of the CRI5 torque control ratchet

The processes described below must be performed before the first use and before each subsequent operation. The repetition of the processes described in this section does not significantly modify the characteristics of these devices.

Failure to follow these instructions may cause cross-infections. Containers and transports to be used for washing: no special requirements.

As soon as possible after each use, the ratchet must be placed in a container filled with a disinfectant/cleansing solution and totally covered with a cloth. This prevents the drying out of contaminants from the patient, dissolving them and making later cleaning easier and more effective.

Totally dismantle the key as indicated below:

Completely unscrew the torque adjustment screw and remove the spring inside the ratchet body handle. Do not separate the spring from the pin that acts as a stop.



Use the hexagonal tip at the end of the torque adjustment screw to unscrew and completely extract the tightening screw of the cover on the side marked OUT. Use only light pressure to avoid damaging the hexagonal tip.



After removing the cover, extract the toothed ratchet wheel and the wheel lock from inside the head of the ratchet.



In case of manual cleaning, clean the outer and inner surfaces of the instrument mechanically under hot water with a soft bristle brush. Rinse the difficultly accessible holes of the head and the area around the ratchet wheel and the wheel lock by injecting hot water with a needleless syringe. If necessary, proceed in the same way for the inside of the handle and of the torque adjustment device. Use a suitable neutral detergent and follow the manufacturer's instructions. Using the brush, apply the detergent to all surfaces. Rinse with distilled water for at least four minutes. Make sure the running water passes abundantly through the passages. In case of automated ultrasound cleaning, use an ultrasound bath with a suitable detergent solution.

Use only neutral detergents. Follow the manufacturer's instructions for detergent concentrations and washing times. Use demineralized water to prevent the formation of stains and marks. During this operation, avoid contact between components, as this causes the deterioration of machined surfaces, and consequently the loss of precision in torque measurements. When draining washing water, check that all residues have been removed from devices, holes, etc. If necessary, repeat the operation or clean manually.

Observation: Residues of blood and other deposits reduce the effectiveness of the sterilization process, and it is therefore essential to clean the ratchet thoroughly. During cleaning operations, avoid splashes or sprays of liquids, and always work wearing suitable protection equipment. Avoid contact between this instrument and other nickel-plated instruments. Components must be reassembled before sterilization. Dry the components, lightly lubricate functional areas and reassemble the key as shown in the illustrations below. Excessive lubricant may spread to the surface of the instrument during sterilization. Use only the lubricant supplied.

After lubricating the parts shown in the illustration, insert the two components of the ratchet head, with first the ratchet wheel and then the wheel stop.



Lubricate the contact areas between the ratchet wheel and the pin of the wheel stop.



After inserting and lubricating components 2 and 3 in the head of the ratchet, position the cover and turn the ratchet from the side marked OUT. Tighten the screw with the hexagonal tip of the torque adjustment screw.



Lubricate the spring inside the ratchet handle as shown in the illustration. Assemble the torque adjustment screw, checking the instrument for correct operation and manually activating the ratchet wheel.



Sterilization: In a vacuum autoclave, proceeding as follows:

- autoclave (gravity displacement cycle) at a temperature of 121°C with minimum exposure of 30 minutes and drying cycle of 15 minutes.

This procedure is essential to maintain the precision of the instrument within a tolerance range of ± 3.5 Ncm. Operate the torque and insertion mechanism to check its correct operation.

Remove all traces of lubricant from the external surfaces of the key. Place the device in a suitable sterilization bag. Disassembly and reassembly operations must be carried out following the instructions provided.

Responsibility for defective products and warranty terms

Optimal care of the patients and attention to their needs are necessary conditions for the success of implant procedures, and they must therefore be carefully selected and informed of the associated risks and obligations associated with the treatment, and encouraged to cooperate with the dentist to ensure the success of the treatment. The patient must therefore practise good oral hygiene, which should be confirmed during regular check-ups. This must always be verified and documented, and similarly, all indications and instructions of the clinician must also be observed and documented. The warranty covers manufacturing defects only, on condition that the faulty product is identified by the article code and batch number and returned within the period of validity of the warranty.



The guarantee terms are accessible at
www.sweden-martina.com

Warning – Limitations of guarantee

The prosthetic components manufactured by Sweden & Martina are intended for use with dental implants and prosthetic instruments also manufactured by Sweden & Martina.

The use of non-original components limits the liability of Sweden & Martina SpA and invalidates the product guarantee.

The prosthetic components must be tightened onto implants using specific instruments. It is advisable to use only instruments manufactured by Sweden & Martina for screwing operations. No liability can be accepted if non-original instruments are used.













The instruments manufactured by Sweden & Martina are intended for use with dental implants and prosthetic components also manufactured by Sweden & Martina.

The use of instruments for operations with implants other than those manufactured by Sweden & Martina limits the liability of Sweden & Martina and invalidates the product guarantee. No liability can be accepted if non-original instruments are used.









Disposal

If removed from the oral cavity due to biological or mechanical failure, prosthetic components must be disposed of as biological wastes. Instruments are made from small components, usually in metal. They may therefore be disposed of as metal wastes. If dirty, they must be disposed of as biological wastes. In general, local regulations on waste disposal must be followed.









Key to symbols used on implant packs:

description	symbol
Caution! See instructions for use	
Batch number	
Code	
Manufacturer	
Consult instructions for use	
CE conformity mark for class IIa and IIb products	
American federal law restricts this device to sale by or by order of a professional practitioner	
Do not resterilize	
Disposable product, do not reuse	
Do not use if the packaging is damaged	
Sterilized with ionizing radiation	
Expiry date after which the product must not be used	

Key to symbols used on surgical instrument packs:

description	symbol
Caution! See instructions for use	
Batch number	
Code	
Manufacturer	
Consult instructions for use	
CE conformity mark for class IIa and IIb products	
CE conformity mark for class I products	
American federal law restricts this device to sale by or by order of a professional practitioner	
Non-sterile product	

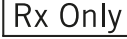
Key to symbols used on prosthesis packs:

description	symbol
Caution! See instructions for use	
Batch number	
Code	
Manufacturer	
Consult instructions for use	
CE conformity mark for class IIa and IIb products	
CE conformity mark for class I products	
American federal law restricts this device to sale by or by order of a professional practitioner	
Disposable product, do not reuse	
Non-sterile product	

THIS MANUAL WAS LAST UPDATED IN APRIL 2017.

The medical devices addressed by this manual have been designed and manufactured in accordance with the most recent directives and harmonized standards applicable to the materials used, production processes, the information supplied and packaging.



rev.03-22



Sweden & Martina S.p.A.

Via Veneto, 10
35020 Due Carrare (PD), Italy
Tel. +39.049.9124300
Fax +39.049.9124290
info@sweden-martina.com
www.sweden-martina.com

Sweden & Martina Ltd

Unit 1b
Amberley Court, Whitworth Road
Crawley, West Sussex, RH11 7XL
Toll free 0800 1123575
info.uk@sweden-martina.com

Sweden & Martina Ireland Ltd

Suite 4.01 Ormond Building,
31-36 Ormond Quay Upper,
Aran Quay D07 F6DC, Dublin 7
Phone +44(0)1293 302013
info.uk@sweden-martina.com

**Sweden & Martina Inc.
Distributor for U.S.**

4700 S Mill Ave, Ste B-16
PO Box 23748 - Tempe, AZ 85282
Toll free 1-844-8MARTINA(1-844-862-7846)
info.us@sweden-martina.com
www.sweden-martinainc.com

Sweden & Martina Mediterranea S.L.

España - info.es@sweden-martina.com

Sweden & Martina Lda

Portugal - info.pt@sweden-martina.com

The implants, standard prosthetic components and surgical instruments contained in this catalogue are Medical devices and are manufactured by Sweden & Martina S.p.A. They conform to the ISO 9001 and ISO 13485 standards and are certified with the CE Mark (Class I) and CE 0476 mark (Class IIA and class IIB) in compliance with European Medical Device Directive No. 93/42 and European Directive No. 2007/47/CE.

We have met the good manufacturing standards (GMP) set forth by many countries worldwide, including the United States FDA.



Some products may not be regulatory/released for sale in all markets.

All trademarks herein are the property of Sweden & Martina S.p.A. unless otherwise indicated.

This material is intended for laboratories and clinicians and is not intended for patient distribution.

This material is not to be redistributed, duplicated, or disclosed without the express written consent of Sweden & Martina S.p.A.

For additional product information, including indications, contraindications, warnings, precautions, and potential adverse effects, see Sweden & Martina S.p.A. website.

The contents are updated at the time of publication. Check with the company for any subsequent updates.