



CONICO



Conico conometric technique

- Collex One connection
- Pre-made Conico posts for implants with Collex One connection
- DAT connection
- Healing abutments
- Pre-made Conico posts for implants with DAT connection
- Conometric Conico caps

4
6
7
8
9
10
12



Prosthetic instruments

- Screwdrivers for fixation screws
- Torque-control ratchet

14
14
15



Protocols for use

- Impression taking and model making with One Abutment-One Time technique
- Definitive single rehabilitation with conometric technique
- Definitive multiple rehabilitation with conometric technique
- Caps for special needs
- Rehabilitation with intraoral welding technique

16
16
18
20
22
23

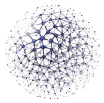

General indications

- Composition of the materials
- General clinical indications
- Coating materials

26
26
28
29

Conico conometric technique

Conico system allows to obtain a fixed restoration on implant without the use of cement or fixation screws between the post and the prosthesis, and at the same time easily removable by the clinician.

The conometric prosthesis is to be considered a fixed prosthesis, like screw retained and cemented solutions and combines the advantages of both: revision and absence of cement of the screw-retained prosthesis and aesthetics and absence of holes in the occlusal area of the cemented prosthesis. Moreover, the ease of removal allows a correct maintenance of the health of the peri-implant tissues, with a considerable saving of time and costs for both the patient and the technician.



Advantages of conometric rehabilitation

- **Excellent retention:** the connection between the conical cap incorporated in the superstructure and the post offers absolute and safe mechanical stability.
- **Easy to remove:** at any time the clinician can remove the prosthesis by applying a minimum force, in order to perform a follow up and/or the hygiene.
- **Ease of use:** the most coronal portion of the posts is standard, therefore both the straight and the angled ones fit the same conometric cap.
- **Comfort for the patient** who enjoys the stability of a fixed prosthesis together with the advantage of being able to easily remove it at the dental office during professional hygiene sessions.
- **Different possibilities of rehabilitation:** the conometric technique allows restorations from single elements to entire arches both in immediate and in delayed loading or in guided surgery.
- **Natural passivation** of the posts which guarantees a perfect fit between prosthesis and abutment.

The Conico system includes a set of caps that allows to exploit the conometry both in case of immediate and delayed loading, also in combination with intraoral welding techniques.



Cap for impression taking: in PEEK, allows you to take advantage of the benefits of the One Abutment-One Time technique, taking the impression directly on posts.



Conometric cap for partial or full-arch fixed prosthesis: in titanium, once incorporated inside the prosthesis it is fastened by conometry to the posts, without the need for screws or cement.



Non-rotating conometric cap for single element: designed for single restoration, it has a flat face on the internal and external surface which helps to find the correct positioning.



Cap for screw retained restoration: can be used on straight Conico posts for CSR, equipped with a thread on the top, allows to convert a conometric prosthesis into a screw retained one, depending on clinician requirements.

Collex One connection

The Collex connection, documented since 1996, is characterized by a large internal hexagon and a collar that guides the prosthetic maneuvers, interpenetrating the post. This interlocking solution manages to confer stability and solidity to the implant-prosthetic complex, helping the correct distribution of chewing loads.

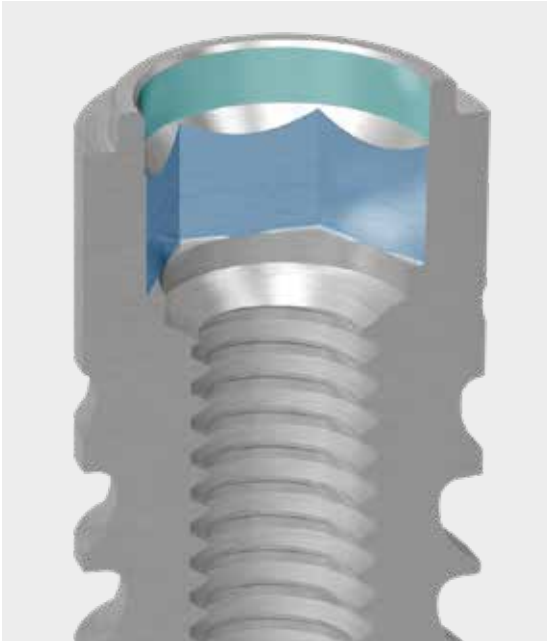

The strength properties of the Collex One connection are documented by various studies in which higher values in terms of strength and prosthetic stability of the Collex One have been showed compared to other connections without collar.

Covani U., Ricci M., Tonelli P., Barone A.

An evaluation of new designs in implant-abutment connections: a finite element method assessment
Implant Dentistry Volume 22, Number 3 2013

Marchetti E., Ratta S., Mummolo S., Tecco S., Pecci R., Bedini R., Marzo G.

Evaluation of an Endosseous Oral Implant System According to UNI EN ISO 14801 Fatigue Test Protocol
Implant Dent 2014;0:1-7

Sweden & Martina implants with Collex One connection are: Premium One, Kohno One, Shelta and Prama. Available in different diameters, these implants share a single connection platform, with a 2.30 mm hexagon, which makes surgical and prosthetic management considerably simplified.



PREMIUM KOHNO ONE



SHELTA

















PRAMA

Pre-made Conico posts for implants with Collex One connection

Conico posts for implants with Collex One connection rest safely on the implant collar and are available in diameters \varnothing 3.30 and \varnothing 3.80 mm. Straight posts are available with different transmucosal heights, while angled posts are available with an angle of 7.5°, 15° and 22.5°. Both types have a repositioning hexagon.

Straight and angled posts

prosthetic component \varnothing	\varnothing 3.30 mm	\varnothing 3.80 mm
for implants	Prama - all the diameters Premium One \varnothing 3.30 mm Premium One, Kohno One, Shelta \varnothing 3.80 mm	Premium One, Shelta \varnothing 3.80 - 4.25 - 5.00 mm Shelta \varnothing 6.00 mm
Conico posts in Gr. 5 titanium straight engaging transgingival h 0.50 mm fixation screw included	A-MD-TS-330-05 	-
Conico posts in Gr. 5 titanium straight engaging transgingival h 1.00 mm fixation screw included	A-MD-TS-330-10 	A-MD-TS-380-10 
Conico posts in Gr. 5 titanium straight engaging transgingival h 2.00 mm fixation screw included	A-MD-TS-330-20 	A-MD-TS-380-20 
Conico posts in Gr. 5 titanium straight engaging transgingival h 3.00 mm fixation screw included	A-MD-TS-330-30 	A-MD-TS-380-30 
Conico posts in Gr. 5 titanium angled at 7.5° engaging transgingival h 2.00 mm fixation screw included	A-MA07-TS-330-2 	A-MA07-TS-380-2 
Conico posts in Gr. 5 titanium angled at 15° engaging transgingival h 2.00 mm fixation screw included	A-MA15-TS-330-2 	A-MA15-TS-380-2 
Conico posts in Gr. 5 titanium angled at 22.5° engaging transgingival h 2.00 mm fixation screw included	A-MA20-TS-330-2 	A-MA20-TS-380-2 
single pack pack of 10 pieces fixation screw supplied with posts, it can also be ordered separately as a spare	VM2-180 VM2-180-10 	Use VM2-180

Important warning

Prosthetic components with \varnothing 3.30 mm are used to create prosthetic Platform Switching with \varnothing 3.80 mm implants. It is recommended to use these posts exclusively for single crowns in the anterior sectors (excluding premolars), or to support multiple restorations in distal sector and not to use them with \varnothing 4.25, 5.00 and 6.00 mm implants.

DAT connection

The DAT (Double Action Tight) connection of CSR implants is a double conical contact interface connection between the post and the implant and between the screw and the post which guarantees an excellent seal against the bacterial infiltrate, preserving the bone from the risk of peri-implant infections that could affect a correct osseointegration and the consequent implant survival. The DAT connection is present in all diameters of the CSR implant system, with the exception of the reduced diameters of \varnothing 3.00 and \varnothing 3.50 mm, which feature the DAT-N connection that is the double conical interface connection in the narrow version, which provides the same benefits of the DAT connection, while maintaining a safety thickness.

Gherlone E.F., Capparè P., Pasciuta R., Grusovin M.G., Mancini N., Burioni R.

Evaluation of resistance against bacterial microleakage of a new conical implant-abutment connection versus conventional connections: an in vitro study



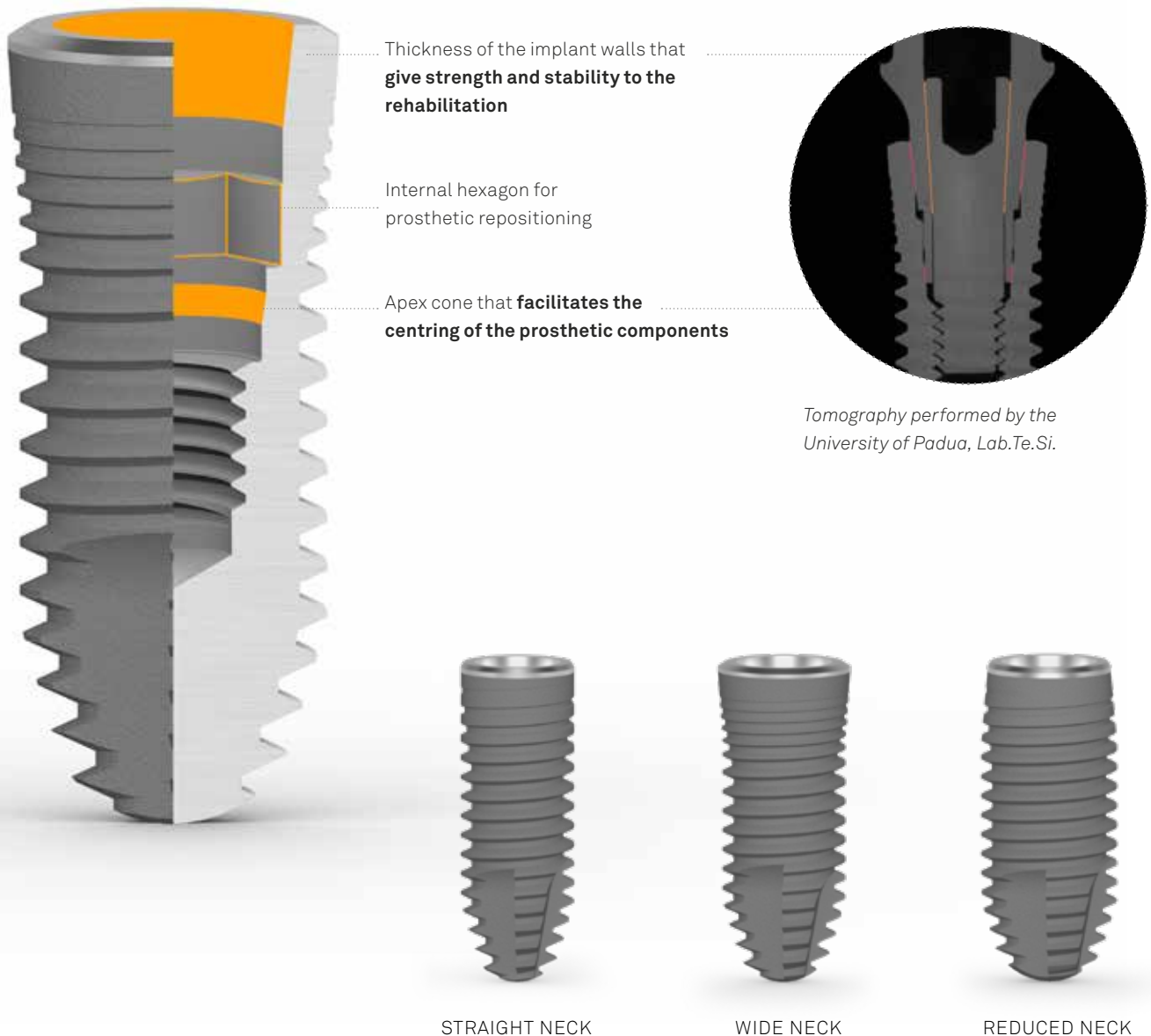





New Microbiol. 2016 Jan;39(1):49-56



Healing abutments

For the realization of the conometric prosthesis on CSR implants with double conical interface connection, healing abutments with straight emergence are also available, which keep the transmucosal tunnel narrow for the subsequent use of Conico posts.

Healing abutments are available both for the DAT connection and for the DAT-N connection and have a laser mark on one side that allows to recognize the type of connection and the transmucosal height.

connection	DAT-N	DAT
for implants	CSR ϕ 3.00 y ϕ 3.50 mm Straight Neck	CSR ϕ 3.80 mm Straight and Wide Neck ϕ 4.20 mm Wide and Reduced Neck ϕ 5.00 mm Reduced Neck
direct screw retained healing abutments in Gr. 5 titanium straight emergence transgingival h 1.50 mm	VSR-TMG-N-15-D 	VSR-TMG-15-D 
direct screw retained healing abutments in Gr. 5 titanium straight emergence transgingival h 3.00 mm	VSR-TMG-N-30-D 	VSR-TMG-30-D 
direct screw retained healing abutments in Gr. 5 titanium straight emergence transgingival h 4.50 mm	VSR-TMG-N-45-D 	VSR-TMG-45-D 
direct screw retained healing abutments in Gr. 5 titanium straight emergence transgingival h 5.50 mm	VSR-TMG-N-55-D 	VSR-TMG-55-D 

Recommended torque: 8-10 Ncm.

Pre-made Conico posts for implants with DAT connection

Conical posts for CSR implants are available both for DAT connection and for DAT-N connection. Straight Conico posts are one-piece, direct screw retained. Thanks to the thread inside the coronal portion, they can be used both for screw retained prosthesis and for conometric prosthesis, depending on clinician and technician needs.

Straight Conico posts are available in different transmucosal heights, as well as the angled posts, available with an angle of 7.5 °, 15 ° and 22.5 °, which enable a complete rotation of 360 °.

The connection platform of CSR implants has a bevel at the coronal level that allows to move the crestal bone away from the implant connection, thereby providing a Platform Switching directly in the morphology of the fixture.

Straight posts

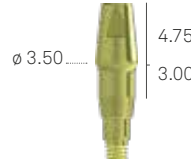
connection	DAT-N	DAT
for implants	CSR ϕ 3.00 and ϕ 3.50 mm Straight Neck	CSR ϕ 3.80 mm Straight and Wide Neck ϕ 4.20 mm Wide and Reduced Neck ϕ 5.00 mm Reduced Neck
Conico posts in Gr. 5 titanium straight direct screw retained transgingival h 1.00 mm	VSR-MDAD-TS-10-N 	VSR-MDAD-TS-10 
Conico posts in Gr. 5 titanium straight direct screw retained transgingival h 2.00 mm	VSR-MDAD-TS-20-N 	VSR-MDAD-TS-20 
Conico posts in Gr. 5 titanium straight direct screw retained transgingival h 3.00 mm	VSR-MDAD-TS-30-N 	VSR-MDAD-TS-30 
Conico posts in Gr. 5 titanium straight direct screw retained transgingival h 4.00 mm	VSR-MDAD-TS-40-N 	VSR-MDAD-TS-40 

Recommended torque: 25-30 Ncm.

Angled posts

connection	DAT-N	DAT
for implants	CSR ϕ 3.00 and ϕ 3.50 mm Straight Neck	CSR ϕ 3.80 mm Straight and Wide Neck ϕ 4.20 mm Wide and Reduced Neck ϕ 5.00 mm Reduced Neck
Conico posts in Gr. 5 titanium angled at 7.5° transgingival h 1.00 mm non engaging fixation screw included	VSR-MA07-TS-1-N 	VSR-MA07-TS-1 
Conico posts in Gr. 5 titanium angled at 7.5° transgingival h 2.00 mm non engaging fixation screw included	VSR-MA07-TS-2-N 	VSR-MA07-TS-2 
Conico posts in Gr. 5 titanium angled at 7.5° transgingival h 3.00 mm non engaging fixation screw included	VSR-MA07-TS-3-N 	VSR-MA07-TS-3 
Conico posts in Gr. 5 titanium angled at 15° transgingival h 1.00 mm non engaging fixation screw included	VSR-MA15-TS-1-N 	VSR-MA15-TS-1 
Conico posts in Gr. 5 titanium angled at 15° transgingival h 2.00 mm non engaging fixation screw included	VSR-MA15-TS-2-N 	VSR-MA15-TS-2 
Conico posts in Gr. 5 titanium angled at 15° transgingival h 3.00 mm non engaging fixation screw included	VSR-MA15-TS-3-N 	VSR-MA15-TS-3 
Conico posts in Gr. 5 titanium angled at 22.5° transgingival h 1.00 mm non engaging fixation screw included	VSR-MA20-TS-1-N 	VSR-MA20-TS-1 
Conico posts in Gr. 5 titanium angled at 22.5° transgingival h 2.00 mm non engaging fixation screw included	VSR-MA20-TS-2-N 	VSR-MA20-TS-2 
Conico posts in Gr. 5 titanium angled at 22.5° transgingival h 3.00 mm non engaging fixation screw included	VSR-MA20-TS-3-N 	VSR-MA20-TS-3 
single pack pack of 10 pieces fixation screw included, puede pedirse también por separado	VSR-VM-160-L VSR-VM-160-L-10 	VM-180-L VM-180-L-10 

Conico conometric caps

The easiness of the Conico conometry is due to the fact that caps of the range are universal both with respect to posts diameters and angles and with respect to implant platform diameters. This is possible because retention by conometry occurs in the conical portion of the post which always has the same dimensions.

Conico caps on straight posts

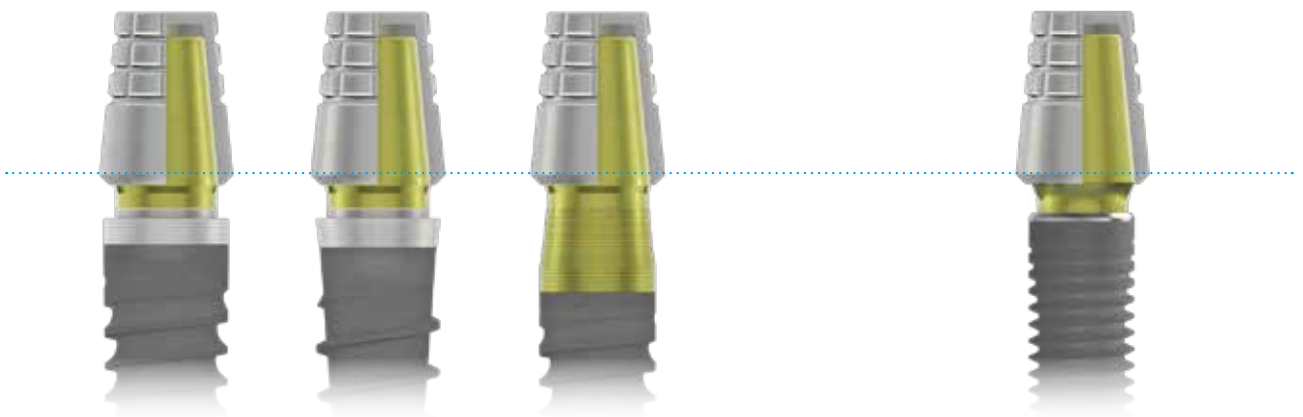

Implants with Collex One connection





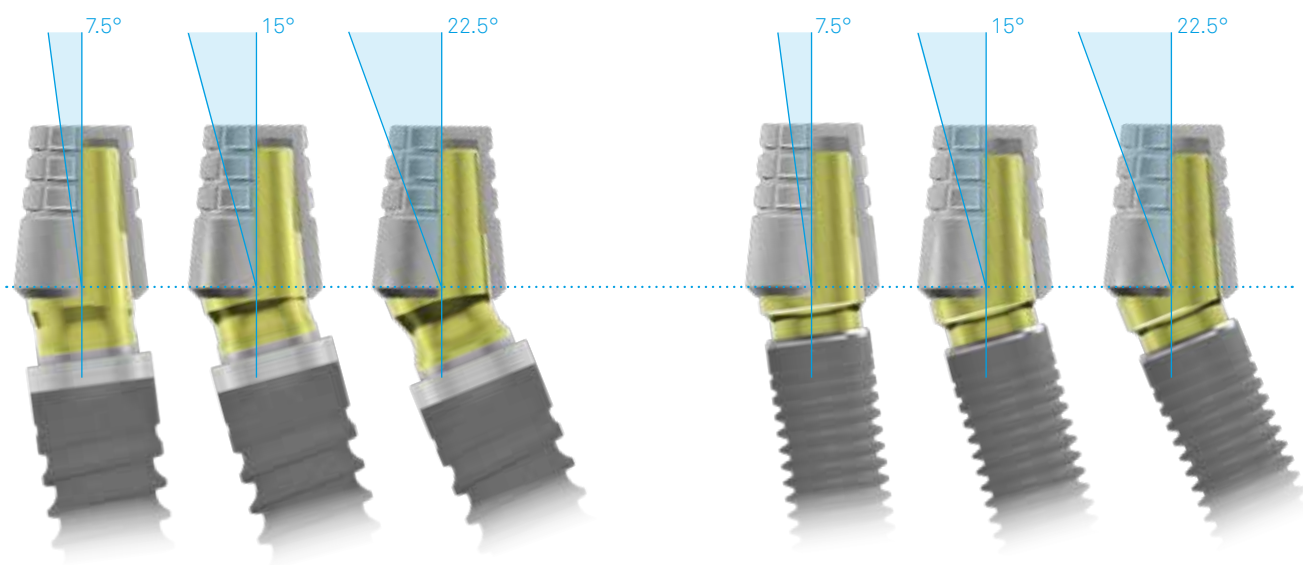

Implants with DAT connection

Conico caps on angled posts





Implants with Collex One connection

Implants with DAT connection

description	code
cap for partial or full-arch fixed prosthesis	CAP2-TS-DEF  5.70
non-rotating cap for single element	CAP2-TS-IND  5.70
cap for screw retained prosthesis fixation screw VP2-CAP2-AVV included	CAP2-TS-AVV  6.95
fixation screw for cap for screw retained prosthesis supplied with the post, it can also be ordered separately as a spare	VP200-CAP2-AVV  M2.0
PEEK transfer cap for direct impression on Conico abutment	CAP2-TS-IMP  9.10
Conico post analog	ANA2-MD-TS  16.50

Drivers for fixation screws

Driver for contra-angle handpiece

description	code	included in the kit
driver with shank for contra-angle handpiece	HSM-20-CA 	ZPREMIUM-ONE-INT ZSHELTA-INT ZPRAMA-INT ZCSR-INT ZPRESH-INT
driver with shank for contra-angle handpiece extra-short	HSMXS-20-CA 	Not included in the surgical kit, available separately

Digital drivers

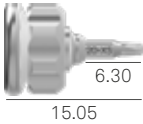
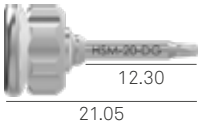
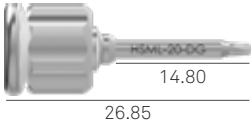
description	code	included in the kit
digital driver, extra-short	HSMXS-20-DG 	ZPREMIUM-ONE-INT ZSHELTA-INT ZPRAMA-INT ZCSR-INT ZPRESH-INT
digital driver, short	HSM-20-DG 	ZPREMIUM-ONE-INT ZSHELTA-INT ZPRAMA-INT ZCSR-INT ZPRESH-INT
digital driver, long	HSML-20-DG 	ZPREMIUM-ONE-INT ZSHELTA-INT ZPRAMA-INT ZCSR-INT ZPRESH-INT

Prosthetic drivers that can be used with the torque control ratchet

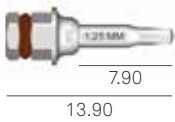
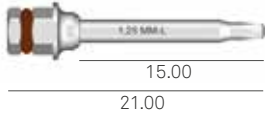
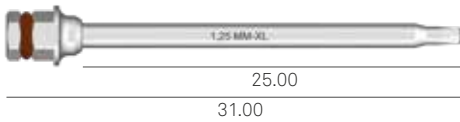
description	code	included in the kit
driver with hexagonal connector, short	HSM-20-EX 	ZPREMIUM-ONE-INT ZSHELTA-INT ZPRAMA-INT ZCSR-INT ZPRESH-INT
driver with hexagonal connector, long	HSML-20-EX 	ZPREMIUM-ONE-INT ZSHELTA-INT ZPRAMA-INT ZCSR-INT ZPRESH-INT
driver with hexagonal connector, extra-long	HSMXL-20-EX 	ZCSR-INT

Torque-control ratchet

description	code	included in the kit
torque-control ratchet complete with accessories for quick torque adjustment and periodic maintenance (Allen and lubricant). The ratchet can be used in a dynamometric function with torque control from 10 to 70 Ncm with intermediate adjustments at 10-20-25-30-25-50-70 Ncm or in fixed mode	CR15-KIT 	ZPREMIUM-ONE-INT ZSHELTA-INT ZPRAMA-INT ZPRESH-INT

Protocols for use

Impression taking and model making with One Abutment-One Time technique

At the time of the reopening or, if there are requirements for immediate loading, at the end of the surgery, place the Conico post of the desired transgingival height and/or angle onto the implant. Insert the PEEK cap (code CAP2-TS-IMP) on the post with a slight manual pression.



Choose a tray of suitable dimensions, so that all the vertical dimension of the cap and the post is contained inside the walls of the impression tray. Inject a precision material (i.e. SKY IMPLANT LIGHT, code SKY14) around the cap. Fill the impression tray with a more consistant impression material (SKY IMPLANT ONEMIX-ED, code SKY08) over the entire arch.



Then position the tray *in situ* and wait for the hardening times as indicated by the instructions.



Lift the tray off vertically: the PEEK cap will remain incorporated in the impression material, while the post will remain retained to the implant.



Reposition the Conico post analog inside the cap and send the impression to the laboratory. Develop the model as usual.



Definitive single rehabilitation with conometric technique

On the precision model, position the indexed conometric cap (code CAP2-TS-IND) on the analog with the help of the repositioning face and activate the conometry exerting a vertical force on the head of the cap.



Perform a wax-up of the crown by placing a laboratory spacer as usual to passivate the final prosthesis and allow subsequent luting. The cap will be in direct contact with the structure only on the occlusal flat surface to allow a precise reset of the structure both on the model in the laboratory and in the various intraoral test phases.



Cast or duplicate with CAD-CAM technologies the crown made of wax or resin, leaving the Conico cap on the model.



Finish the base of the crown and proceed with the ceramic coating. Do not proceed to luting the crown on the cap yet.



Insert the definitive conometric cap on the post (code CAP2-TS-IND) with the help of the repositioning face and activate the conometry with a slight manual pressure.



Lute the ceramic crown to the cap: for this purpose, it is useful to apply a thin layer of primer such as ZPrime inside the crown, before proceeding with the cementation with BisCem.

Once activated, the conometric retention of the cap is maintained constant also thanks to the occlusal contact, avoiding the possibility that the crown comes off or that the patient can remove it independently.



Definitive multiple rehabilitation with conometric technique

On the precision model, position the indexed conometric caps (code CAP2-TS-IND) on the analogs and activate the conometry exerting a vertical force on the head of the caps.



Perform a wax-up of the structure by placing a laboratory spacer as usual to passivate the final prosthesis and allow subsequent luting.

Caps will be in direct contact with the structure only on the occlusal flat surface to allow a precise reset of the structure both on the model in the laboratory and in the various intraoral test phases.



Cast or duplicate with CAD-CAM technologies the structure made of wax or resin, leaving the Conico caps on the model.



Finish the base of the structure and proceed with the ceramic coating. Do not proceed to luting the structure on the caps yet.



Insert the definitive conometric caps on each post (code CAP2-TS-IND) and activate the conometry with a slight manual pressure.



Lute the ceramic crown to the caps: for this purpose, it is useful to apply a thin layer of primer such as ZPrime inside the structure, before proceeding with the cementation with BisCem. Once activated, the conometric retention of the caps is maintained constant also thanks to the occlusal contact, avoiding the possibility that the structure comes out or that the patient can remove it independently.

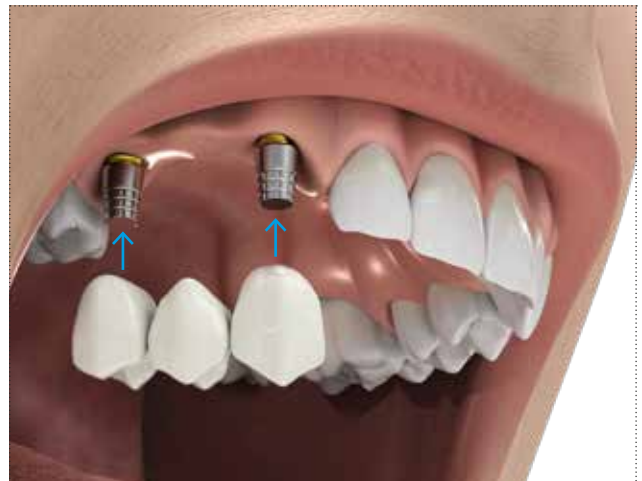

Caps for special needs







CAP2-TS-REM cap for the removal: to be used exclusively in particular conditions of multiple rehabilitations or full-arch structures, in the case of patients with parafunctions.

The presence of an internal thread allows to engage a screw with M2 thread (e.g. screw code VM2-200) in order to deactivate the conometry and consequently remove the prosthesis.

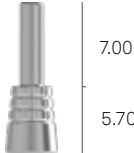

CAP2-TS-PIN cap for intraoral welding: in immediate loading procedures the pin allows to splint the caps with the intraoral welding avoiding the risk of fusion between the cap and the post.

Components for conometry with intraoral welding

description	code
cap with pin, to be used for intraoral welding	CAP2-TS-PIN 
pack of 5 pieces bar in Gr. 2 titanium with circular profile l 150 mm, ø 1.20 mm	DW-BARRA1.2 
pack of 5 pieces bar in Gr. 2 titanium with circular profile l 150 mm, ø 1.50 mm	DW-BARRA1.5 
pack of 5 pieces bar in Gr. 2 titanium with circular profile l 150 mm, ø 1.80 mm	DW-BARRA1.8 
pack of 5 pieces bar in Gr. 2 titanium with rectangular profile l 100 mm, 3x1 mm	DW-BARRA1X3 
pack of 5 pieces bar in Gr. 2 titanium with rectangular profile l 100 mm, 4x2 mm	DW-BARRA2X4 

Rehabilitation with intraoral welding technique

Position the caps for intraoral welding (code CAP2-TS-PIN) on the posts, gently applying manual pressure.



Take a Gr. 2 titanium bar for intraoral welding of the most suitable thickness (choosing from those available on page 22) and manually precurve it congruently with the area to be rehabilitated. Position it near the pin on the top of the cap.

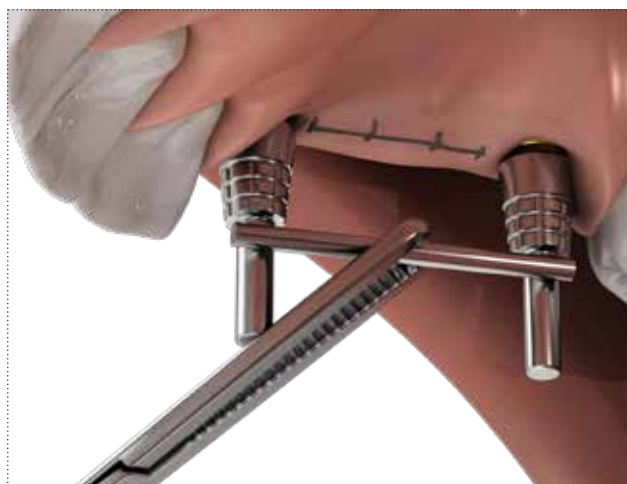

Perform a welding with a special intraoral welding machine, according to the manufacturer's instructions. The welding between the pin and the bar ensures that there is no fusion between the conometric cap and the post.

Important warning

To set the operating parameters for the welding machine and for the relevant informations and warnings, read and follow the instructions in the manual issued by the manufacturer of the equipment.



Proceed with the welding on the pin of the second cap. In order to further increase the passive nature of the structure and eliminate any residual stress, welding is advisable at a halfway point along each segment of free titanium along the bar.



In order to reduce the total vertical dimension, remove the caps welded to the bar and eliminate the portion of excess pin.



The prosthesis can be made in the laboratory or chair-side, relining a pre-made moulded prosthesis prepared previously by the dental technician. In this case, it is always advisable to check the size of the structure inside the pre-made prosthesis before proceeding with the subsequent steps.

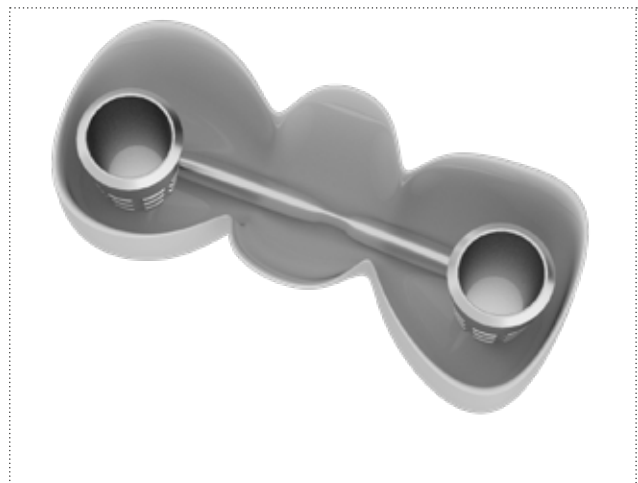

Position again the structure composed of the two caps welded to the bar in the patient's mouth and proceed with the direct relining by means of the pre-made prosthesis filled with resin, eliminating the excess material. The resin will incorporate the welded structure entirely, which also makes it easier for the patient to clean it at home.



Remove the relined prosthesis, finish and polish it.

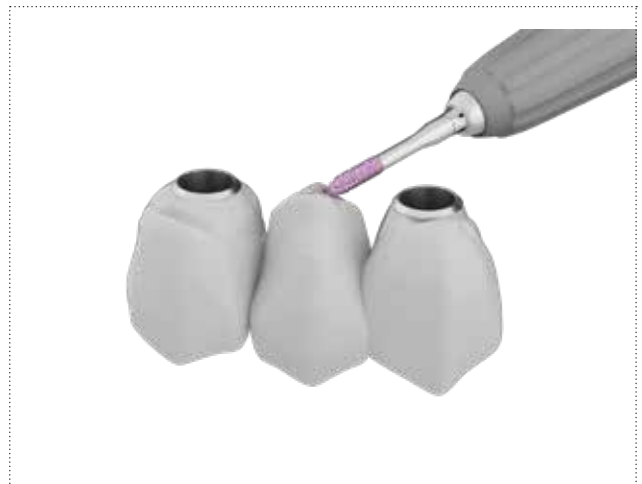

Proceed with positioning the prosthesis on the Conico posts and activate it with a slight manual pressure: the interaction by conometry between the posts and the caps will give the structure the right retentivity, that will allow the clinician to remove the prosthesis in any moment, but will not allow the patient to remove it independently.

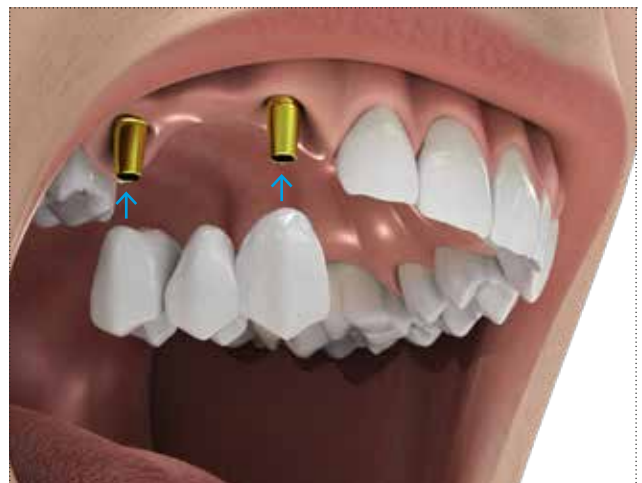

Composition of the materials

Gr. 2 titanium* ASTM F67-13, ISO 5832-2:2012

chemical composition	maximum allowed values (%)	tolerance
nitrogen	0.03	+/- 0.02
carbon	0.08	+/- 0.02
hydrogen	0.015	+/- 0.002
iron	0.30	+/- 0.10 (%<0.25) +/- 0.15 (%>0.25)
oxygen	0.25	+/- 0.02 (%<0.20) +/- 0.03 (%>0.20)
titanium	remainder	-

* This technical information complies with the express specifications of the regulations in force on the use of titanium Gr. 2 in implantology

Gr. 5 titanium* ASTM F136-13, ISO 5832-3:2012

chemical composition:	maximum allowed values (%)	tolerance
nitrogen	0.05	+/- 0.02
carbon	0.08	+/- 0.02
hydrogen	0.012	+/- 0.002
iron	0.25	+/- 0.10
oxygen	0.13	+/- 0.02
aluminium	5.5÷6.5	+/- 0.40
vanadium	3.5÷4.5	+/- 0.15
titanium	remainder	-

*This technical information complies with the express specifications of the regulations in force on the use of Gr. 5 titanium in implantology:

- ASTM F 136-13: Standard Specification for wrought Titanium-6 Aluminium-4 Vanadium Eli (Extra low interstitial) Alloy for surgical applications;
- ISO 5832-3:2012: Implant for surgery - Metallic materials - Part 3: wrought Titanium-6 Aluminium-4 Vanadium Alloy.

PEEK

PEEK	
chemical designation	polyether ether ketone
colour	opaque white cream

physical and mechanical properties	
density	1.14 g/cm ³
modulus of elasticity in tension (DIN EN ISO 527-2)	4100 MPa
yield strength (DIN EN ISO 527-2)	>90 MPa
yield strength at 0.2% (DIN EN ISO 527-2)	>70 MPa
elongation at 0.2 % (DIN EN ISO 527-2)	5 %
elongation at break (DIN EN ISO 527-2)	13 %
flexural strength (DIN EN ISO 178)	174 MPa
modulus of flexural elasticity (DIN EN ISO 178)	4000 MPa
modulus of compressibility (EN ISO 604)	3500 MPa

thermal properties	
glass transition temperature	150 °C
maximum temperature for short-term use	300 °C
maximum temperature for continuous use	260 °C

chemical properties	
absorption at 23°C in 24/96 hours(DIN EN ISO 62)	0.02/0.03%

General clinical indications

Modern implant prosthetics, for both immediate or deferred loading, is a widely experimented and reliable discipline that is able to resolve virtually all problems of functional or aesthetic edentulism. An implant prosthesis may replace a single tooth (implant-supported crown), a group of adjacent teeth (implant-supported bridge), or an entire dental arch.

This manual addresses the production of prostheses for all disciplines of implant rehabilitation.

Implant-prosthetic rehabilitation must respect several fundamental criteria:

- the presence of a certain quantity of bone;
- the primary stability of the inserted implants;
- good periodontal (gingival) support;
- the absence of bruxism (tooth grinding) and serious malocclusions;
- the presence of good occlusal balance (correct masticatory occlusal plane).

Warnings and contraindications

When assessing patients, in addition to considering their suitability for implant-prosthetic rehabilitation, it is usually necessary to take into account the contraindications applicable to all operations of dental surgery.

These may include:

- clotting disorders, anticoagulant therapies in progress;
- healing or bone regeneration disorders;
- decompensated diabetes mellitus;
- metabolic or systemic diseases that compromise tissue regeneration, and with effects in particular on tissue healing and bone regeneration;
- alcohol abuse, smoking and use of drugs;
- immunosuppressive therapy, such as chemotherapy and radiotherapy;
- infections and inflammations, such as periodontitis and gingivitis;
- poor oral hygiene;
- insufficient motivation;
- occlusion and/or articulation disorders, and also inadequate interocclusal space;
- inadequate alveolar process.

It is contraindicated to fit implants and implant restorations in patients with poor general or oral health, those who are unable to monitor their general conditions properly or those who have had organ transplants. Psychologically unstable patients, alcohol or drug abusers and poorly motivated or uncooperative patients should also be considered unsuitable for this kind of treatment. Patients with poor periodontal health should first be treated and allowed to recover. In the presence of a lack of bone substance or poor quality of the receiving bone, such as to compromise the stability of the implant, suitable guided tissue regeneration must be performed prior to implant treatment and bone grafting procedures. Contraindications can also include: allergies to titanium, acute or chronic infectious diseases, sub-acute chronic maxillary osteitis, systemic diseases, endocrine disorders, diseases resulting in microvascular disorders, pregnancy, breastfeeding, previous exposure to radiation, haemophilia, granulocytopenia, use of steroids, diabetes mellitus, kidney failure and fibrous dysplasia. The normal contraindications common to all oral surgery must also be observed. Patients following anti-coagulant, anticonvulsant and immunosuppressant therapies, with active inflammatory-infective processes of the oral cavity, and patients with BUN and creatinine values outside the norm, must not be subjected to surgery. Patients with cardiovascular disease, hypertension, thyroid or parathyroid diseases, malignant tumours found in the five years preceding the operation or nodular swellings must also be assessed with particular attention. Chemotherapies reduce or eliminate the ability of osseointegration, and patients undergoing these treatments must therefore be carefully screened before being rehabilitated with oral implant prostheses. Numerous cases of bisphosphonate-associated peri-implant osteonecrosis of the mandible have been reported in literature. This problem applies in particular to patients receiving intravenous treatments.

Prostheses must always be planned in advance. Prosthetic planning must be carried out in collaboration with the dental technician. Guided prosthetic insertion of implants facilitates the work of the practitioner, and offers greater guarantees of longer prosthesis lifespan. Complete clinical, radiological and radiographic documentation should be collected and stored on file. Every product pack shows the product code, a description of contents and the batch number. These details are also indicated on the labels to be attached to the patient's records, and must always be cited by the practitioner in any correspondence regarding the products. When handling these medical devices, both during actual use and during cleaning and sterilization procedures, surgical gloves must always be worn for individual protection against bacterial contamination. Failure to follow this precaution may expose the patient to infection. Packaging conforms to International standards..

Information on applicable standards

The medical devices addressed by this instruction manual have been designed and manufactured in accordance with the most recent directives and harmonized standards applicable to the materials used, production processes, the information supplied and packaging. Every product pack shows the product code, a description of contents and the batch number. These details, which are also indicated on labels included in packs, must always be cited by the practitioner in any correspondence regarding the products. The prosthetic components and instruments manufactured by Sweden & Martina contains no materials of human or animal origin, and are free from phthalates. Patients must be asked if they are allergic to any of the materials used. Although titanium allergies are possible, these are very rare. Patients should therefore always be asked if they have allergies of this type. Refer to pages 84–90 for technical details on all materials used, for checks on the respective chemical compositions, and for physical and mechanical characteristics.

Identification of the manufacturer

Manufacturer of the prosthetic components and instruments described in this manual:

Sweden & Martina

Via Veneto 10
35020 Due Carrare (Padova) - Italia
Tel. +39 049.9124300 - Fax + 39 049.9124290
e-mail: info@sweden-martina.com
www.sweden-martina.com

Coating materials

By prof. Eriberto Bressan

This innovative technique in no way limits the technician and the clinician in the use of different materials. As for the framework, different materials and alloys can be used. Likewise, resin, ceramic, composite or zirconia can be used for prosthetic veneering materials, depending on the clinical cases, experience and preparation of technicians and clinicians. Compared to the most common screw retained or cemented solutions, the conometric technique requires neither fixation screws nor cement between prostheses and posts: this is not only a biologic advantage for implant maintenance, but also involves a reduction in costs and chairside time.



rev. 05-20



Sweden & Martina S.p.A.

Via Veneto, 10
35020 Due Carrare (PD), Italy
Tel. +39.049.9124300
Fax +39.049.9124290
info@sweden-martina.com

www.sweden-martina.com

Sweden & Martina Ltd

Unit 45
Basepoint Business Centre
Metcalf Way, Crawley,
West Sussex, RH11 7XX, UK
Toll free 0800 1123575
info.uk@sweden-martina.com

**Sweden & Martina Inc.
Distributor for U.S.**

637 S.48th St. - Suite 21
Tempe, AZ 85281
Toll free 1-844-8MARTINA (1-844-862-7846)
info.us@sweden-martina.com

www.sweden-martinainc.com

Sweden & Martina Mediterranea S.L. - España

info.es@sweden-martina.com
Sweden & Martina Lda - Portugal
info.pt@sweden-martina.com

The implants, standard prosthetic components and surgical instruments contained in this catalogue are Medical devices and are manufactured by Sweden & Martina S.p.A. They conform to the ISO 9001 and ISO 13485 standards and are certified with the CE Mark (Class I) and CE 0476 mark (Class IIA and class IIB) in compliance with Regulation (EU) Medical Devices n. 2017/745.
The Sweden & Martina plant manufactures Medical Devices in compliance with the CGMPs in force in the USA and in other countries worldwide.



Some products may not be regulatory/released for sale in all markets.
All trademarks herein are the property of Sweden & Martina S.p.A. unless otherwise indicated.
This material is intended for laboratories and clinicians and is not intended for patient distribution.
This material is not to be redistributed, duplicated, or disclosed without the express written consent of Sweden & Martina S.p.A.
For additional product information, including indications, contraindications, warnings, precautions, and potential adverse effects, see Sweden & Martina S.p.A. website.

The contents are updated at the time of publication. Check with the company for any subsequent updates.